



# CENNIK

## PRICELIST

Aktualny od ▪ *Valid from:* 16.03.2020

aktualizacja ▪ *updated:* 21.03.2020

CENY PODANE W CENNIKU NIE ZAWIERAJĄ PODATKU VAT  
*RATES IN THIS PRICELIST ARE NET PRICES*

Przyjmujemy realizację płatności za zakupione towary i usługi kartami płatniczymi i kredytowymi.  
*We accept debit and credit cards as payment for purchased goods and services.*



<b>LINDAB</b>	<b>10</b>
Zawory wentylacyjne Lindab Airy <i>Lindab Airy air valves</i>	<b>12</b>
Nawiewniki/wywiewniki <i>Diffusers</i>	<b>13</b>
Skrzynki rozprężne, przewody tłumiące, kratki <i>Plenum boxes, flexible silencers, grilles</i>	<b>19</b>
Smart Tools	<b>21</b>
Wybrane produkty dostępne na zapytanie ofertowe	<b>22</b>



## **KANAŁY WENTYLACYJNE OKRĄGŁE** **VENTILATION ROUND DUCTS**

Rury zwijane <i>Circular ducts</i>	<b>24</b>
SPIRBOX - bezpieczny system transportu rur zwijanych SPIRO® <i>SPIRBOX - Pipe transportation</i>	<b>26</b>
Mocowanie kanału <i>Duct support</i>	<b>27</b>



## **KSZTAŁTKI WENTYLACYJNE OKRĄGŁE** **VENTILATION ROUND FITTINGS**

Kolana tłoczone <i>Pressed bends</i>	<b>28</b>
Kolana segmentowe <i>Segmented bends</i>	<b>30</b>
Redukcje tłoczone <i>Pressed reducers</i>	<b>32</b>
Redukcje segmentowe <i>Hand made reducers</i>	<b>34</b>
Trójniki symetryczne, Trójniki niesymetryczne, Trójniki orłowe <i>T-pieces, Twin bends</i>	<b>36</b>
Sztucery siodłowe <i>Collar saddles</i>	<b>42</b>
Sztucery, Nyple, Mufy, Zaślepki <i>Collars, Coupling, Duct end caps</i>	<b>43</b>
Sztucery cylindryczne <i>Branchings</i>	<b>50</b>

\* nowość w cenniku - new



**ELASTYCZNE PRZEWODY WENTYLACYJNE**  
*VENTILATION FLEXIBLE DUCTS*

Przewód półelastyczny S-Flex® <i>S-Flex® Semi-rigid aluminium ducts</i>	<b>53</b>
Elastyczne przewody wentylacyjne <i>Aluminium flexible ducts</i>	<b>54</b>
Outulina Sleeve, Elastyczne przewody PVC, Tłumik elastyczny <i>Insulation Sleeve, Flexible PVC ducts, Flexible acoustic silencer</i>	<b>55</b>



**KANAŁY I KSZTAŁTKI WENTYLACYJNE PROSTOKĄTNE**  
*RECTANGULAR DUCTS AND FITTINGS*

Kanały i kształtki prostokątne typu AI <i>Rectangular ducts and fittings, type AI</i>	<b>57</b>
--	-----------



**ODDYMIAJĄCE KANAŁY I KSZTAŁTKI PROSTOKĄTNE**  
*SMOKE CONTROL RECTANGULAR DUCTS AND FITTINGS*

System wentylacji pożarowej <i>Smoke control system</i>	<b>58</b>
--	-----------



**SYSTEM WENTYLACJI ROZDZIELACZOWEJ**  
*INTEGRATED MANIFOLD DISTRIBUTION VENTILATION SYSTEM*

Elastyczny przewód dwuwarstwowy <i>Double layer elastic duct</i>	<b>59</b>
Rozdzielacze przelotowe dwurzędowe <i>Double row through manifolds</i>	<b>60</b>
Rozdzielacze kątowe jednorzędowe i niesymetryczne <i>Single row and asymmetric angular manifolds</i>	<b>61</b>
Skrzynki rozprężne SR-T <i>Plenum boxes SR-T</i>	<b>62</b>



**PRZEPUSTNICE WENTYLACYJNE**  
*DAMPERS*

Przepustnice jednopłaszczyznowe okrągłe <i>Circular duct dampers</i>	<b>63</b>
Przepustnice IRIS, zwrotne, nastawne regulatory stałego przepływu <i>Duct damper type IRIS, back draft dampers, flow regulators</i>	<b>66</b>

\* nowość w cenniku - new

Przepustnice wielopłaszczyznowe i samoczynne aluminiowe <i>Multi-leaf and automatic aluminium dampers</i>	<b>68</b>
--	-----------



**OSPRZĘT WENTYLACYJNY**  
**VENTILATION EQUIPMENT**

Czerpnie / wyrzutnie prostokątne i okrągłe <i>Rectangular and round air intakes/exhausters</i>	<b>72</b>
Klapy rewizyjne <i>Accesss doors</i>	<b>76</b>
Nasady kominowe, kominek, podstawy dachowe <i>Chimney roots, ventilation caps, roof base</i>	<b>77</b>
Filtry kanałowe szufladowe i okrągłe <i>Round duct and cassette filters</i>	<b>81</b>
Kratki - typ AI <i>Grilles - type AI</i>	<b>82</b>
Króćce elastyczne prostokątne i okrągłe <i>Rectangular and circular flexible duct connectors</i>	<b>83</b>



**TŁUMIKI AKUSTYCZNE**  
**ACOUSTIC SILENCERS**

Tłumiki akustyczne okrągłe proste <i>Circular silencers</i>	<b>84</b>
Łącznik półelastyczny, tłumiki akustyczne płytowe <i>Semiflexible connector, rectangular silencers</i>	<b>85</b>



**MATERIAŁY MONTAŻOWE**  
**ASSEMBLY MATERIALS**

Obejmy do rur <i>Pipe clips for round ducts</i>	<b>87</b>
Opaski zaciskowe, opaski montażowe <i>Band clip, supressing bands</i>	<b>88</b>
Zawiesia, nakrętki złączne, pręty gwintowane <i>Suspension, connecting nuts, threaded rods</i>	<b>89</b>
Wieszaki Gripple <i>Gripple hangers</i>	<b>90</b>
Konsole kątowe, blachowkręty, tuleje kotwiące <i>Consoles, self-drilling screws, anchor bushes</i>	<b>91</b>

\* nowość w cenniku - new



Zacisk kanału, podstawa profilu, końcówki do blachowkrętów <i>Duct clips, profile base, terminals for screws</i>	<b>92</b>
Silikon, uszczelki, śruby dwugwintowe, pianka montażowa <i>Silicone, Self-adhesive seals, double-threaded screws, assembly foam</i>	<b>93</b>
Śruby, nakrętki, taśmy perforowane, podkładki <i>Screws, nuts, Perforates suspension banding, washers</i>	<b>94</b>
Guma amortyzująca, gumki amortyzujące, Kształtowniki <i>Shock absorbing rubber, cushioning rubbers, Support channels</i>	<b>95</b>
Lindab SolidFoot Uniwersalny system podstaw i wsporników montażowych do urządzeń HVAC <i>Universal base and supports system for HVAC units</i>	<b>96</b>
Big Foot Systems Systemy wsporników do instalacji i urządzeń dachowych <i>Rooftop Building Services Support Systems</i>	<b>100</b>



**MATERIAŁY PRODUKCYJNE**  
**PRODUCTION PROFILES**

Drut miedziany, profile kanałowe, narożniki do profili <i>Copper wire, ductwork profiles, corners</i>	<b>104</b>
Siatka ocynkowana 12×12, Rurka usztywniająca aluminiowa <i>Galvanized steel 12x12 mesh, stiffening aluminium pipe</i>	<b>105</b>
Dyski usztywniające, krzyżak usztywniający <i>Stiffening discs, stiffening steel cross</i>	<b>105</b>
Cynk w sprayu, masa uszczelniająca <i>Alu-Zinc spray, tightening compound</i>	<b>105</b>
Mechanizmy przepustnic, łączniki elastyczne <i>Damper mechanisms, flexible connectors</i>	<b>106</b>
Rączka mechaniczna przepustnicy, łącznik kierownicy kolana <i>Damper hand, turning vane guides for rectangular ducts</i>	<b>107</b>
Nity, Tuleje, Kołnierze <i>Rivets, Bushings, Flanges</i>	<b>108</b>
Elementy produkcyjne przepustnic wielopłaszczyznowych aluminiowych odpornych na temperaturę <i>Production elements of the air tight aluminium multi-leaf dampers</i>	<b>109</b>
Elementy produkcyjne przepustnic wielopłaszczyznowych aluminiowych <i>Production elements of the aluminium multi-leaf dampers</i>	<b>110</b>
Elementy produkcyjne wyrzutni i czerpni prostokątnych aluminiowych i stalowych <i>Production elements of the aluminium and steel rectangular air- intakes and exhausters</i>	<b>111</b>
Elementy produkcyjne przepustnic samoczynnych <i>Production elements of automatic aluminium dampers</i>	<b>112</b>

\* nowość w cenniku • new



**NARZĘDZIA**  
**TOOLS**

Narzędzia blacharskie **113**  
*Metal sheet tools*



**MATERIAŁY IZOLACYJNE**  
**INSULATION MATERIALS**

Izolacje techniczne VENTWOOL **115**  
*VENTwool technical insulation*

Izolacje techniczne ROCKWOOL **116**  
*ROCKWOOL technical insulation*

Gwoździe samoprzylepne, gwoździe do zgrzewania **120**  
*Self-adhesive nails, nails for welding*

Mata termoizolacyjna kauczukowa MST **122**  
*Selfadhesive Thermo Insulating Matt*

Taśmy **122**  
*Tapes*



**ANEMOSTATY, NAWIEWNIKI, KRATKI, ZAWORY POWIETRZNE**  
**DIFFUSERS, GRILLES, VALVES**

Zawory powietrzne **123**  
*Air valves*

Anemostaty sufitowe prostokątne HB40 **126**  
*Square ceiling diffusers HB40*

Anemostaty sufitowe okrągłe DS, DHA, DHPT **126**  
*Round ceiling diffusers DS, DHA, DHPT*

Anemostaty wirowe SW, SD-B, SD-C, DVR **129**  
*Swirl diffusers SW, SD-B, SD-C*

Anemostaty sufitowe prostokątne ASN, ASW **130**  
*ASN/ASW rectangular ceiling diffusers*

Nawiewniki szczelinowe SDML, nawiewniki podłogowe FDS **132**  
*Slot diffusers SDML, floor diffuser FDS*

Dysze dalekiego zasięgu JNS **133**  
*Jet diffusers JNS*

Skrzynki rozprężne i przyłącza montażowe **134**  
*Plenum boxes and round ceiling diffusers*

Kratki ścienne aluminiowe **138**  
*Aluminium wall grilles*

\* nowość w cenniku - new

Kratki ścienne KSH, KSV, KWP <i>Wall grilles KSH, KSV, KWP</i>	<b>140</b>
Maskownice M, Kratki z siatką KWS <i>Frames M, grilles with mesh KWS</i>	<b>147</b>
Kratki podłogowe KNP <i>Floor grilles KNP</i>	<b>148</b>
Kratki wentylacyjne osłonowe maskujące KST <i>Grilles with fixed blades KST</i>	<b>149</b>
Kratki wentylacyjne na kanał zwijany <i>Grilles for the coil duct</i>	<b>150</b>



**CENTRALE WENTYLACYJNE**  
**AIR HANDLING UNITS**

Centrale wentylacyjne SALDA <i>SALDA air handling units</i>	<b>154</b>
Centrale wentylacyjne VENT-AXIA <i>VENT-AXIA air handling units</i>	<b>181</b>



**NAGRZEWNICE POWIETRZA**  
**AIR-HEATERS**

Nagrzewnice wodne i elektryczne SALDA <i>SALDA water and electrical heaters</i>	<b>183</b>
Nagrzewnice powietrza VTS EUROHEAT <i>VTS EUROHEAT air heaters</i>	<b>192</b>
Nagrzewnice wodne i gazowe SONNIGER <i>SONNIGER water and gas heaters</i>	<b>193</b>



**WENTYLATORY**  
**FANS**

Wentylatory Salda <i>Salda fans</i>	<b>194</b>
Wentylatory dachowe VILPE® <i>Vilpe® roof fans</i>	<b>199</b>
Nagrzewnice i wentylatory S&P, Venture Industries <i>S&amp;P, Venture Industries air-heaters and fans</i>	<b>200</b>
Wentylatory, podstawy dachowe i wywietrzaki Uniwersal <i>Universal fans, roof base and graviation fans</i>	<b>206</b>

\* nowość w cenniku - new

Wentylatory Systemair  
*Systemair fans* **210**

Wentylatory Rosenberg  
*Rosenberg fans* **214**



**APARATY GRZEWCZO-WENTYLACYJNE**  
*AIR HANDLING UNITS*

Aparaty grzewczo-wentylacyjne FLOWAIR GROUP  
*FLOWAIR GROUP heating and ventilation units* **218**



**KURTYNY POWIETRZNE**  
*AIR CURTAINS*

Kurtyny powietrzne VTS EUROHEAT  
*VTS EUROHEAT air curtains* **219**

Kurtyny powietrzne RM  
*RM air curtains* **220**

Kurtyny powietrzne SYSTEMAIR  
*SYSTEMAIR air curtains* **221**

Kurtyny powietrzne SONNIGER  
*SONNIGER air curtains* **226**



**KLAPY PRZECIWPÓŻAROWE**  
*FIRE DAMPER*

\* Kłapy przeciwpożarowe okrągłe i prostokątne LINDAB  
*LINDAB round and rectangular fire dampers* **227**

Kłapy przeciwpożarowe okrągłe i prostokątne SMAY  
*SMAY round and rectangular fire dampers* **235**

Kłapy przeciwpożarowe okrągłe i prostokątne MERCOR  
*MERCOR round and rectangular fire dampers* **241**



**SIŁOWNIKI**  
*ACTUATORS*

Siłowniki do przepustnic LUFBERG  
*Actuators for dampers LUFBERG* **245**

Siłowniki do przepustnic i akcesoria do siłowników BELIMO  
*Actuators for dampers and actuators accessories BELIMO* **248**

\* nowość w cenniku - new



**KLIMATYZATORY**  
*AIR-CONDITIONERS*

* Klimatyzatory TCL <i>TCL air-conditioners</i>	<b>252</b>
Klimatyzatory Mistral <i>Mistral air-conditioners</i>	<b>255</b>
Klimatyzatory Samsung <i>Samsung air-conditioners</i>	<b>265</b>
Klimakonwektory Galanz <i>Fan coil units</i>	<b>269</b>



**MATERIAŁY MONTAŻOWE DO KLIMATYZATORÓW**  
*ASSEMBLY ACCESSORIES FOR THE AIR-CONDITIONERS*

Rury miedziane chłodnicze <i>Cooling copper pipes</i>	<b>271</b>
Kształtki montażowe miedziane <i>Copper fittings</i>	<b>273</b>
Czynniki chłodnicze <i>Refrigerants</i>	<b>275</b>
Mocowania skraplacza <i>Condenser's fastening</i>	<b>276</b>
Koryta montażowe, kształtki montażowe PVC <i>PVC assembly trays, PVC assembly profiles</i>	<b>282</b>
Rura do odprowadzania skroplin, pompka skroplin <i>Pipe for drips, drainage pump</i>	<b>282</b>
Regulator obrotów wentylatora, grzałka karteru sprężarki <i>Digital fan speed controller, Compressors casing heater</i>	<b>282</b>
Środki do czyszczenia i konserwacji urządzeń klimatyzacyjnych <i>Cleaning and maintenance agents for air-conditioning devices</i>	<b>283</b>
Opakowanie zbiorcze <i>Collective packaging measurements</i>	<b>284</b>
Warunki dostaw w Polsce <i>Terms of delivery in Poland</i>	<b>285</b>

Sprzedaż produktów przez Lindab Sp. z o.o. z siedzibą w Wieruchowie odbywa się na zasadach określonych w dokumencie **Ogólne warunki sprzedaży produktów Lindab Sp. z o.o.** zamieszczonym na stronach internetowych [www.lindab.pl](http://www.lindab.pl) i [www.lindab-polska.pl](http://www.lindab-polska.pl), a także dostępnym w biurze sprzedaży Lindab Sp. z o.o.

\* nowość w cenniku - new



Od przeszło 50 lat Lindab tworzy i rozwija produkty stosowane do tworzenia wszelkiego rodzaju systemów wentylacyjnych. Dzięki bogatemu doświadczeniu zdobytego na różnych rynkach oraz na podstawie badań przeprowadzanych we własnych laboratoriach, Lindab tworzy produkty o najwyższej jakości i funkcjonalności. Dbalność o szczegóły, niezawodność, przyjazność środowisku to wartości jakie przyświecają nam na każdym etapie tworzenia produktów. Lindab posiada w swojej ofercie kompletne rozwiązania systemowe, które można podzielić na 3 główne grupy produktowe: Air Duct Systems, Comfort, Rozwiązania IT.

### Air Duct Systems - system przepływu powietrza

Do obszaru produktowego ADS zaliczamy kanały i kształtki o przekroju okrągłym, uzupełnione systemami prostokątnymi oraz kominkami wentylacyjnymi. W tej grupie dostępne są również specjalistyczne rozwiązania systemów wentylacyjnych takie jak wykonania np. z blachy kwasoodpornej, systemy do transportu pneumatycznego (Lindab Transfer) czy systemy kanałów preizolowanych (Lindab ISOL) .





## Lindab Comfort

Produkty przyczyniające się do tworzenia komfortowego i zdrowego klimatu wewnątrz, podzielone są na trzy podgrupy: **Airborn Solutions** - produkty, które dostarczają i odprowadzają powietrze z wentylowanego obszaru takie jak kratki, nawiewniki, anemostaty, **Waterborne Solutions** - produkty do wentylacji i klimatyzacji pomieszczeń takie jak: belki chłodzące aktywne i pasywne, panele grzewczo-chłodzące, aparaty indukcyjne, **Acoustic Solutions** - wybór tłumików do komfortowego, cichego systemu wentylacyjnego.



## Rozwiązania IT

Szeroki zakres inteligentnych i użytecznych narzędzi, które ułatwiają codzienną pracę i tworzenie zaawansowanych projektów:

- **CADvent** - pełny zestaw narzędzi do rysowania, wymiarowania, obliczania, kwantyfikacji i prezentacji kompletnej instalacji HVAC (program działa jako nakładka na program AutoCAD®),
- **lindQST.com** - platforma on-line do doboru i symulacji produktów Lindab Comfort,
- **DIMsilencer** - dobór tłumików akustycznych: okrągłych, prostokątnych, kolankowych, etc.
- **TEKNOsim** - precyzyjny program do symulacji klimatu w pomieszczeniu, służący do obliczania temperatur i bilansu cieplnego oraz doboru urządzeń chłodzących i grzewczych.



**W sprawie zamówień prosimy o kontakt z Działem Handlowym Wentylacji Lindab Sp. z o.o.:**

tel. +48 22 250 50 57

tel. +48 22 250 50 17

e-mail: [info@lindab.pl](mailto:info@lindab.pl)

## Zawory wentylacyjne Lindab Airy • Lindab Airy air valves



Nadaj nowy wygląd swojemu salonowi, łazience lub sypialni, polepszając jednocześnie mikroklimat wewnątrz pomieszczeń. Lindab Airy to cienki, wydajny zawór powietrza o nieograniczonych możliwościach i najniższym poziomie dźwięku.

Wolisz czystą biel, wesoły rozbrysł koloru, lub połysk nierdzewnej stali? Niezależnie od preferowanego wyglądu, uzyskasz idealną harmonię mikroklimatu wewnątrz i jego stylu.

Typ • Type	Materiał / RAL • Material / RAL	D [mm]		
		100	125	160
		Cena [PLN/szt.] • Price [PLN/pc]		
Panel front • Airy front plate	9003/9010	cena na zapytanie		
Korpus • Airy body	9003/9010			

## Wybierz kształt:



OKRĄGŁY  
AIRYFP ROUN



KWADRATOWY  
AIRYFP SQUA



ŁUKOWATY  
AIRYFP BOW



ELIPSOIDALNY  
AIRYFP ELLI



PROSTOKĄTNY  
AIRYFP RECT

Przykład zamówienia: AIRYFP BOW 125 RAL 9003 + AIRYB 125 RAL 9003.

Inne kolory na zapytanie ofertowe. • Price for other colors for enquiry.



## Nawiewniki szczelinowe • Slot diffusers

LD-13



Liczba szczelin [mm]	Cena [EUR/szt.]* • Price [EUR/pc]*	
	Bez skrzynki • without plenum box	Ze skrzynką rozprężną • without plenum box
1	cena na zapytanie	
2		
3		
4		

## Nawiewniki szczelinowe • Slot diffusers

LD-14



Liczba szczelin [mm]	Cena [EUR/szt.]* • Price [EUR/pc]*	
	Bez skrzynki • without plenum box	Ze skrzynką rozprężną • without plenum box
1	cena na zapytanie	
2		
3		
4		

\* Cena za 1 m, inne długości na zapytanie.

Wersja aluminium anodyzowana; malowanie - w opcji.

Ceny przeliczane na PLN w dniu sprzedaży wg kursów średnich NBP.

2020-03-16 CENY PODANE W CENNIKU LINDAB SP. Z O.O. NIE ZAWIERAJĄ PODATKU VAT  
/ RATES IN THIS PRICELIST ARE NET PRICES

## Nawiewniki szczelinowe • Slot diffusers

LD-17



Liczba szczelin [mm]	Cena [EUR/szt.]* • Price [EUR/pc]*	
	Bez skrzynki • without plenum box	Ze skrzynką rozprężną • without plenum box
1	cena na zapytanie	
2		
3		
4		

## Nawiewniki wirowe • Swirl diffusers

OD-7



	OD-7/RB	OD-7/RC	OD-7/KB	OD-7/KB/PM
D [mm]	Cena [EUR/szt.] • Price [EUR/pc]			
100	cena na zapytanie			
125				
160				
180				
200				
250				
315				
355				
400				

\* Cena za 1 m, inne długości na zapytanie.  
Wersja aluminium anodyzowana; malowanie - w opcji.

Ceny przeliczane na PLN w dniu sprzedaży wg kursów średnich NBP.

## Nawiewniki wirowe • Swirl diffusers

OD-11



	OD-11	OD-11/P	OD-11V	OD-11V/P	OD-11V/TR	OD-11V/TR/P
D [mm]	Cena [EUR/szt.] • Price [EUR/pc]					
125	cena na zapytanie					
160						
200						
250						
315						
400						
500						
630						
800						

## Nawiewniki sufitowe • Ceiling diffusers

OD-10



Liczba szczelin [mm]	Cena [EUR/szt.] • Price [EUR/pc]	
	OD-10/1	OD-10/2
80	cena na zapytanie	
100		
125		
160		
200		
250		
315		

Ceny przeliczane na PLN w dniu sprzedaży wg kursów średnich NBP.

## Nawiewniki szczelinowe • Slot diffusers

LD-18



Liczba szczelin [mm]	Cena [EUR/szt.]* • Price [EUR/pc]*	
	Bez skrzynki • without plenum box	Ze skrzynką rozprężną • without plenum box
1	cena na zapytanie	
2		
3		
4		

## Dysze dalekiego zasięgu • Ceiling diffusers

VŠ-5



D [mm]	VŠ-5/R		VŠ-5/D/R VŠ-5/K/R		VŠ-5/E/R		VŠ-5/D/TR VŠ-5/K/TR		VŠ-5/E/TR	
	Cena [EUR/szt.] • Price [EUR/pc]									
	RAL 9010	C0	RAL 9010	C0	RAL 9010	C0	RAL 9010	C0	RAL 9010	C0
100	cena na zapytanie									
125										
160										
200										
250										
315										
400										

\* Cena za 1 m, inne długości na zapytanie.

Wersja aluminium anodyzowana; malowanie - w opcji.

Ceny przeliczane na PLN w dniu sprzedaży wg kursów średnich NBP.

## Nawiewniki / wywiewniki • Diffusers

CRL



Wielkość • Size [mm]	Cena [PLN/szt.] • Price [PLN/pc]
100	cena na zapytanie
125	
160	
200	

Wielkość • Size [mm]	Cena [PLN/szt.] • Price [PLN/pc]
250	cena na zapytanie
315	
400	

## Łącznik • Extension piece \*

MBZ



Wielkość • Size [mm]	Cena [PLN/szt.] • Price [PLN/pc]
100	cena na zapytanie
125	
160	
200	

Wielkość • Size [mm]	Cena [PLN/szt.] • Price [PLN/pc]
250	cena na zapytanie
315	
400	

\* element wymagany do połączenia CRL z MBB.

## Nawiewniki / wywiewniki • Diffusers

LCA



Wielkość • Size [mm]	Cena [PLN/szt.] • Price [PLN/pc]
100	cena na zapytanie
125	
160	
200	

Wielkość • Size [mm]	Cena [PLN/szt.] • Price [PLN/pc]
250	cena na zapytanie
315	
400	

## Nawiewniki / wywiewniki • Diffusers

LKA



Wielkość • Size [mm]	Cena [PLN/szt.] • Price [PLN/pc]
<b>125</b>	cena na zapytanie
<b>160</b>	
<b>200</b>	

Wielkość • Size [mm]	Cena [PLN/szt.] • Price [PLN/pc]
<b>250</b>	cena na zapytanie
<b>315</b>	
<b>400</b>	

## Nawiewniki / wywiewniki • Diffusers

LCP / LKP



LCP

Wielkość • Size [mm]	Cena [PLN/szt.] • Price [PLN/pc]
<b>125-1</b>	cena na zapytanie
<b>160-1</b>	
<b>200-1</b>	



LKP

Wielkość • Size [mm]	Cena [PLN/szt.] • Price [PLN/pc]
<b>250-1</b>	cena na zapytanie
<b>315-1</b>	

## Płyta adaptacyjna • Module plate

LM

Wielkość • Size [mm]	Cena [PLN/szt.] • Price [PLN/pc]
<b>LM</b>	cena na zapytanie



## Nawiewniki / wywiewniki • Diffusers

PCA



Wielkość • Size [mm]	Cena [PLN/szt.] • Price [PLN/pc]
<b>100</b>	cena na zapytanie
<b>125</b>	
<b>160</b>	
<b>200</b>	

Wielkość • Size [mm]	Cena [PLN/szt.] • Price [PLN/pc]
<b>250</b>	cena na zapytanie
<b>315</b>	
<b>400</b>	

## Nawiewniki / wywiewniki • Diffusers

PKA



Wielkość • Size [mm]	Cena [PLN/szt.] • Price [PLN/pc]
<b>PKA 125</b>	cena na zapytanie
<b>PKA 160</b>	
<b>PKA 200</b>	

Wielkość • Size [mm]	Cena [PLN/szt.] • Price [PLN/pc]
<b>PKA 250</b>	cena na zapytanie
<b>PKA 315</b>	
<b>PKA 400</b>	

## Skrzynka rozprężna • Plenum box

MB

ød1 [mm]	ød2 [mm]	Cena [PLN/szt.] • Price [PLN/pc]
<b>100</b>	<b>100</b>	cena na zapytanie
<b>100</b>	<b>125</b>	
<b>100</b>	<b>160</b>	
<b>125</b>	<b>125</b>	
<b>125</b>	<b>160</b>	
<b>125</b>	<b>200</b>	
<b>160</b>	<b>160</b>	
<b>160</b>	<b>200</b>	
<b>160</b>	<b>250</b>	

ød1 [mm]	ød2 [mm]	Cena [PLN/szt.] • Price [PLN/pc]
<b>200</b>	<b>200</b>	cena na zapytanie
<b>200</b>	<b>250</b>	
<b>200</b>	<b>315</b>	
<b>250</b>	<b>250</b>	
<b>250</b>	<b>315</b>	
<b>250</b>	<b>400</b>	
<b>315</b>	<b>315</b>	
<b>315</b>	<b>400</b>	



## Przewody tłumiące • Flexible silencers

AKUCOM



Średnica / długość / izolacja • Diameter / length / insulation [mm]	Cena [PLN/szt.] • Price [PLN/pc]
<b>100 / 600 / 25</b>	cena na zapytanie
<b>100 / 1200 / 25</b>	
<b>125 / 600 / 25</b>	
<b>125 / 1200 / 25</b>	
<b>160 / 600 / 25</b>	
<b>160 / 1200 / 25</b>	

Średnica / długość / izolacja • Diameter / length / insulation [mm]	Cena [PLN/szt.] • Price [PLN/pc]
<b>200 / 600 / 25</b>	cena na zapytanie
<b>200 / 1200 / 25</b>	
<b>250 / 600 / 25</b>	
<b>250 / 1200 / 25</b>	
<b>315 / 600 / 25</b>	
<b>315 / 1200 / 25</b>	

## Kratki na przewody okrągłe • Circular duct grilles

RGS



Typ • Type	Cena [PLN/szt.] • Price [PLN/pc]						
	RGS-0	RGS-1	RGS-2	RGS-3	RGS-4	RGS-6	RGS-7
325-75							
325-125							
325-150							
325-225							
425-75							
425-125							
425-150							
425-225							
525-75							
525-125							
525-150							
525-225							
625-75							
625-125							
625-150							
625-225							
825-75							
825-125							
825-150							
825-225							
1025-75							
1025-125							
1025-150							
1025-225							
1225-75							
1225-125							
1225-150							
1225-225							

cena na zapytanie

RGS-0: pojedyncze łopatkę; RGS-1: podwójne łopatkę; RGS-2: pojedyncze łopatkę, z przepustnicą wychylną;  
RGS-3: podwójne łopatkę, z przepustnicą wychylną; RGS-4: pojedyncze łopatkę, z przepustnicą przesuwną;  
RGS-6: pojedyncze łopatkę, z pochyloną przepustnicą przesuwną; RGS-7: podwójne łopatkę, z pochyloną przepustnicą przesuwną;



## SR-Cutter

SRCS2

Nowy, ulepszony SR Cutter zapewnia lepsze warunki pracy i cięcie w ergonomicznej pozycji. Otrzymujesz perfekcyjne cięcie – za każdym razem. SR Cutter tnie kanały do 0,9 mm grubości oraz do 3 m długości w średnicach Ø 80 - Ø 315 mm. Cena nie obejmuje nożyc CSS.



Cena [PLN/szt.] • Price [PLN/pc]

cena na zapytanie

## Nożyce elektryczne • Shears

CSS

Nożyce do cięcia kanałów okrągłych z blachy o grubości do 0,9 mm. Nożyce wykorzystywane są również do ogólnego cięcia blach, ponieważ są łatwe do odłączenia ze stanowiska i wyposażone w zaciski do promienia cięcia.



Cena [PLN/szt.] • Price [PLN/pc]

cena na zapytanie

## SR-Roller

SRR

SRR to urządzenie z ruchomymi rolkami, które służy do oparcia kanałów o średnicy Ø 315-1250 mm. Kanały układa się na 2 lub 3 urządzeniach, które zapewniają podczas zaznaczania i samego cięcia równą obracanie się i co za tym idzie, bardzo równą linię cięcia.



Cena [PLN/szt.] • Price [PLN/pc]

cena na zapytanie

## Tester szczelności • Leakage tester

LTEST

Kompletny zestaw do pomiaru szczelności w systemie wentylacyjnym. Urządzenie jest automatycznie regulowane do wybranego ciśnienia. Wszystko jest wbudowane w urządzenie. Urządzenie automatycznie oblicza nieszczelności oraz sprawdza, czy wybrana klasa szczelności została osiągnięta.



Cena [PLN/szt.] • Price [PLN/pc]

cena na zapytanie

## Wybrane produkty Lindab ICS dostępne na zapytanie ofertowe

### Nawiewniki sufitowe



RS14



PS1



NS19



LCS

### Nawiewniki przemysłowe



RCW



RCWB



FKD



HLD

### Aluminiowe kratki wentylacyjne



B3020



C21



F20



IGR

### Nawiewniki wyporowe

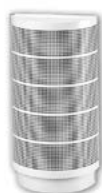

CBA



CKA



CBAL



CCU

## Wybrane produkty Lindab ICS dostępne na zapytanie ofertowe

### Dysze nawiewne



GTI

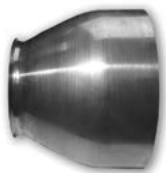

LAD



GD

### Belki chłodzące i panele grzewcze



Professor



Premax



Plexus



Atrium

### Konwektory podłogowe



TK



TKH



TK-S



TKV

### Nawiewniki ściennie i zawory transferowe



DR24



NR19



OLR

Pełna oferta  
produktów Lindab  
dostępna  
na stronie:  
[www.lindab.pl](http://www.lindab.pl)



## Rura zwijana z blachy stalowej ocynkowanej - Circular duct (galvanized steel)

RZ

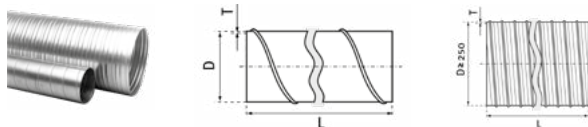

Rury zwijane z blachy stalowej ocynkowanej, wykonane w klasie ocynku Z200-Z275, minimalna masa powłoki obustronnie 200-275 g/m<sup>2</sup>, zgodnie z PN-EN 10346.

Circular ducts made of zinc coated steel sheet, class Z200-Z275, min. mass of two-sided zinc coat 200-275 g/m<sup>2</sup> according to the PN-EN 10346.

øD [mm]	Grubość ścianki - Wall thickness [mm]							
	T=0,50		T=0,60		T=0,70		T=0,90	
	PLN / m	PLN / szt.	PLN / m	PLN / szt.	PLN / m	PLN / szt.	PLN / m	PLN / szt.
80	34,09	102,27						
100	41,41	124,23						
125	52,02	156,06						
140	57,06	171,18						
150	62,32	186,96						
160	65,30	195,90						
180	74,68	224,04						
200	82,09	246,27						
224	92,19	276,57						
250	102,90	308,70						
280	114,54	343,62						
300	122,36	367,08						
315	129,47	388,41						
355	180,35	541,05						
400	200,64	601,92						
450	230,21	690,63						
500			316,42	949,26				
560			362,46	1 087,38				
630			407,88	1 223,64				
710					466,59	1 399,77		
800					525,82	1 577,46		
900					813,08	2 439,24		
1000							863,86	2 591,58
1250							1 088,50	3 265,50

Niestandardowe grubości ścianki - cena na zapytanie ofertowe  
Price for not standard wall thicknesses for enquiry.

Długość standardowa L: 3 m (do ø560) / 2,7 m (od ø630) - Standard lengths L: 3 m (≤ ø560) / 2,7 m (≥ ø630).

Długości niestandardowe: 2500≤L<3000 mm: dopłata - extra charge +5%, 1000≤L<2000 mm: dopłata - extra charge +20%,

Non-standard lengths: 2000≤L<2500 mm: dopłata - extra charge +10%, L<1000 mm: dopłata - extra charge +30%.



Rura zwijana ze stali kwasoodpornej - Circular duct (stainless steel)

RZ-S



Grubość blachy: 0,5 mm (ø80-ø400) / 0,6 mm (ø450-ø630) / 0,8 mm (ø710-ø1000).

Sheet thickness: 0,5 mm (ø80-ø400) / 0,6 mm (ø450-ø630) / 0,8 mm (ø710-ø1000).

øD [mm]	Cena - Price	
	PLN / m	PLN / 3m
80	96,82	290,46
100	116,60	349,80
125	144,41	433,23
150	184,47	553,41
160	195,49	586,47
180	218,36	655,08
200	240,81	722,43
224	271,61	814,83
250	298,80	896,40
280	360,81	1 082,43
300	389,75	1 169,25
315	408,19	1 224,57
355	481,63	1 444,89
400	546,42	1 639,26
450	688,97	2 066,91
500	811,85	2 435,55
560	976,75	2 930,25
600	971,50	2 914,50
630	1 013,52	3 040,56
710	1 294,20	3 882,60
800	1 451,37	4 354,11
900	1 635,85	4 907,55
1000	1 994,08	5 982,24

UWAGA: długości standardowe L=3000 mm. Inne średnice na zapytanie ofertowe.

Możliwość wykonania rur o grubości blachy 0,8 mm.

ATTENTION: standard lengths are L=3000 mm. Price for other diameter for enquiry.

On individual demand ducts can be produced of 0,8mm thick material.



## SPIRBOX - bezpieczny system transportu rur SPIRO® • Pipe transportation

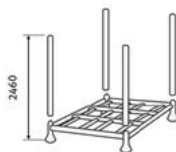
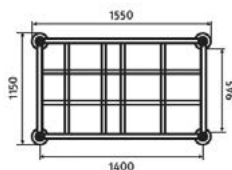

Kupując rury zwijane SPIRO® z dostawą w systemie SPIRBOX klient kupuje również kosz SPIRBOX (**800 zł netto** za każdy kosz SPIRBOX). Lindab odkupuje kosze SPIRBOX od klientów za tę samą cenę.

Ordering coil ducts in a SPIRBOX delivery system You are also purchasing SPIRBOX box (750 PLN per one SPIROBOX). Lindab buys the boxes back at the same price.

øD [mm]	Ilość rur (3 mb) w koszu SPIRBOX • Pipe quantity (3m) in a box [szt. • pc]	kosz SPIRBOX • SPIRBOX box	SPIRBOX MIX dodatek. średnica do zestawu w zakresie • additional diameter range [mm]
100	200	824 PLN	80
125	130		80 - 100
150	94		80 - 125
160	80		80 - 150
200	48		80 - 180
250	30		-
315	20		-

**UWAGA!** Ze względu na możliwość uszkodzenia produktu w czasie transportu, w kosze SPIRBOX MIX pakowane są maksymalnie dwie różne średnice.

*Attention!* To ensure minimum damage to the transported foods in Spirbox Mix Boxes we transport a maximum of 2 different duct diameters.

## Składany kosz na produkty • Foldable metal rack



Kosz do transportu i przechowywania produktów, ocynkowany ogniowo.

*Metal rack for transport and handling of metal products, hot-dip galvanized.*

Długość • Length [mm]	Szerokość • Width [mm]	Wysokość • Height [mm]	Waga • Weight [kg]	Cena [PLN/szt.] • Price [PLN/pc]
1230	820	970	69	772,50



### Mocowanie kanału • Duct support

MDR



Używane do przytwierdzenia kanału na jego złączeniach. W podstawie znajdują się otwory do montażu.

Used to fix ducts standing on joists. Is provided with fixing holes in the base.

øD [mm]	Cena [PLN/szt.] • Price [PLN/pc]
<b>80</b>	27,71
<b>100</b>	27,71
<b>125</b>	36,05
<b>140</b>	38,21
<b>150</b>	40,38
<b>160</b>	42,54
<b>180</b>	52,43
<b>200</b>	62,52
<b>224</b>	64,89
<b>250</b>	67,26

øD [mm]	Cena [PLN/szt.] • Price [PLN/pc]
<b>280</b>	74,26
<b>300</b>	81,47
<b>315</b>	84,36
<b>355</b>	95,58
<b>400</b>	106,71
<b>450</b>	124,12
<b>500</b>	141,52
<b>560</b>	183,24
<b>630</b>	224,75



### Kolano tłoczone SAFE bez uszczelki • Pressed bend without gasket

**B**



	90°	60°	45°	30°	15°
øD [mm]	Cena [PLN/szt.] • Price [PLN/pc]				
<b>80</b>	42,64	72,62	34,30	37,08	59,64
<b>100</b>	43,36	51,60	34,30	37,08	51,60
<b>125</b>	53,97	57,47	40,69	43,47	57,99
<b>150</b>	74,68	104,13	55,21	59,64	77,46
<b>160</b>	78,49	108,46	58,50	61,18	67,77
<b>180</b>	102,38	132,36	72,51	77,46	91,98
<b>200</b>	115,98	130,71	77,35	85,49	88,68
<b>250</b>	192,61	x	125,15	x	x

### Kolano tłoczone z uszczelką • Pressed bend with gasket

**BL**



	90°	60°	45°	30°	15°
øD [mm]	Cena [PLN/szt.] • Price [PLN/pc]				
<b>80</b>	59,64	88,48	52,22	53,77	75,91
<b>100</b>	64,17	67,98	52,32	53,77	67,98
<b>125</b>	76,32	75,91	60,56	60,05	74,26
<b>150</b>	95,38	124,94	70,56	79,10	96,61
<b>160</b>	102,07	128,24	79,93	82,19	88,48
<b>180</b>	118,76	150,48	82,61	96,82	122,78
<b>200</b>	137,20	154,40	96,61	107,53	112,06
<b>250</b>	207,03	x	141,01	x	x

Wykonanie z: blachy stalowej ocynkowanej - w klasie ocynku Z275, minimalna masa powłoki obustronnie 275 g/m<sup>2</sup>, zgodnie z PN-EN 10346.

Completed out of: galvanized steel - in class Z275, min. mass of two-sided zinc coat 275 g/m<sup>2</sup> according to the PN-EN 10346.





## Kolano krótkie nypłowe/nypłowo-mufowe 90° • 90° Short pressed bend

**BFK(M)L**

Kolano tłoczone, zgrzewane liniowo z krótkim promieniem, który ułatwia montaż w miejscach trudno dostępnych. • Used to fix ducts standing on joists. Is provided with fixing holes in the base.



øD [mm]	Cena [PLN/szt.] • Price [PLN/pc]	
	BFKL	BFKML
<b>100</b>	59,23	77,97
<b>125</b>	69,73	88,79
<b>160</b>	86,21	102,49

## Kolano tłoczone bez uszczelki (stal kwasoodporna)

• Pressed bend without gasket (stainless steel)

**B-S**



øD [mm]	90°	45°
	Cena [PLN/szt.] • Price [PLN/pc]	
<b>100</b>	182,31	143,89
<b>125</b>	226,60	170,67
<b>160</b>	329,50	245,96
<b>200</b>	486,88	324,76

## Kolano tłoczone z uszczelką (stal kwasoodporna)

• Pressed bend with gasket (stainless steel)

**BL-S**



øD [mm]	90°	45°
	Cena [PLN/szt.] • Price [PLN/pc]	
<b>100</b>	269,55	219,91
<b>125</b>	320,64	254,31
<b>160</b>	428,58	335,47
<b>200</b>	576,18	405,72

Wykonanie z: blachy stalowej ocynkowanej - w klasie ocynku Z275, minimalna masa powłoki obustronnie 275 g/m<sup>2</sup>, zgodnie z PN-EN 10346; ze stali kwasoodpornej - 1.4301 EN 10088.

Completed out of: galvanized steel - in class Z275, min. mass of two-sided zinc coat 275 g/m<sup>2</sup> according to the PN-EN 10346; stainless steel - 1.4301 EN 10088.



## Kolano segmentowe bez uszczelki • Segmented bend without gasket

**BFE**



	90°	60°	45°	30°	15°
øD [mm]	Cena [PLN/szt.] • Price [PLN/pc]				
<b>224</b>	79,21	69,63	61,29	46,87	42,23
<b>250</b>	80,75	71,07	62,52	47,79	43,05
<b>315</b>	104,55	85,18	81,58	56,96	51,40
<b>355</b>	147,60	130,91	105,68	77,56	69,73
<b>400</b>	175,41	155,53	125,56	92,19	82,92
<b>450</b>	225,16	198,17	149,45	114,02	102,59
<b>500</b>	269,65	243,49	183,44	149,97	134,93
<b>630</b>	452,99	416,12	344,33	248,44	223,51
<b>710</b>	747,99	636,85	475,76	341,75	292,73
<b>800</b>	842,95	741,81	536,22	402,11	361,94
<b>1000</b>	1 410,07	1 240,64	806,80	582,77	524,48

Na zamówienie • On request: ø280, ø300, ø350, ø560, ø900, ø1120, ø1250.

## Kolano segmentowe bez uszczelki (stal kwasoodporna)

• Segmented bend without gasket (stainless steel)

**BFE-S**



	90°	45°
øD [mm]	Cena [PLN/szt.] • Price [PLN/pc]	
<b>250</b>	339,18	262,55
<b>315</b>	439,19	342,27
<b>355</b>	620,16	443,93
<b>400</b>	736,86	527,46
<b>450</b>	945,75	627,89
<b>500</b>	1 132,38	770,23
<b>630</b>	1 902,72	1 446,33

Wykonanie z: blachy stalowej ocynkowanej - w klasie ocynku Z275, minimalna masa powłoki obustronnie 275 g/m<sup>2</sup>, zgodnie z PN-EN 10346; ze stali kwasoodpornej - 1.4301 EN 10088.

Completed out of: galvanized steel - in class Z275, min. mass of two-sided zinc coat 275 g/m<sup>2</sup> according to the PN-EN 10346; stainless steel - 1.4301 EN 10088.



## Kolano segmentowe z uszczelką • Segmented bend with gasket

**BFL**



	90°	60°	45°	30°	15°
∅D [mm]	Cena [PLN/szt.] • Price [PLN/pc]				
<b>224</b>	104,13	101,87	101,76	91,57	91,16
<b>250</b>	104,13	101,87	101,76	91,57	91,16
<b>315</b>	137,71	122,57	122,36	110,11	109,59
<b>355</b>	181,18	161,20	160,99	144,92	144,30
<b>400</b>	224,64	199,82	199,61	179,74	178,91
<b>450</b>	286,65	255,03	254,72	229,28	228,25
<b>500</b>	352,36	313,43	298,19	281,81	280,57
<b>630</b>	623,46	592,35	446,40	421,99	419,93
<b>710</b>	920,61	874,47	659,30	622,94	620,06
<b>800</b>	1 022,79	971,70	732,54	692,16	688,97
<b>1000</b>	1 645,22	1 562,92	1 178,22	1 113,33	1 108,07

Na zamówienie • On request: ∅280, ∅300, ∅350, ∅560, ∅900, ∅1120, ∅1250.

Wykonanie z: blachy stalowej ocynkowanej - w klasie ocynku Z275, minimalna masa powłoki obustronnie 275 g/m<sup>2</sup>, zgodnie z PN-EN 10346.

Completed out of: galvanized steel - in class Z275, min. mass of two-sided zinc coat 275 g/m<sup>2</sup> according to the PN-EN 10346.



**Redukcja tłoczona SAFE bez uszczelki • Pressed reducer without gasket**

**RC**



øD [mm]	Cena [PLN/szt.] • Price [PLN/pc]										
	øB [mm]										
	100	125	150	160	180	200	224	250	300	315	
<b>80</b>	29,97	35,43	x	36,57	x	x	x	x	x	x	x
<b>100</b>	x	35,43	35,74	36,87	48,00	49,34	x	x	x	x	x
<b>125</b>	x	x	35,74	35,95	48,00	49,34	x	64,58	x	x	x
<b>150</b>	x	x	x	39,35	48,00	49,34	68,50	64,58	x	x	x
<b>160</b>	x	x	x	x	48,00	47,07	68,50	64,58	x	86,31	x
<b>180</b>	x	x	x	x	x	47,07	x	64,58	x	x	x
<b>200</b>	x	x	x	x	x	x	58,92	64,58	88,37	86,31	x
<b>224</b>	x	x	x	x	x	x	x	64,58	x	x	x
<b>250</b>	x	x	x	x	x	x	x	x	85,90	85,70	x

**Redukcja tłoczona z uszczelką • Pressed reducer with gasket**

**RCPL**

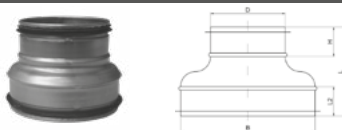

øD [mm]	Cena [PLN/szt.] • Price [PLN/pc]										
	øB [mm]										
	100	125	150	160	180	200	224	250	300	315	355
<b>80</b>	47,48	53,77	x	56,34	x	x	x	x	x	x	x
<b>100</b>	x	53,77	62,42	56,34	75,50	73,34	x	x	x	x	x
<b>125</b>	x	x	62,42	56,34	75,50	73,34	x	x	x	x	x
<b>150</b>	x	x	x	x	73,85	71,69	68,50	x	x	x	x
<b>160</b>	x	x	x	x	73,85	71,69	98,26	95,48	x	119,38	x
<b>200</b>	x	x	x	x	x	x	98,26	97,03	122,67	122,67	x
<b>224</b>	x	x	x	x	x	x	x	97,03	x	x	x
<b>250</b>	x	x	x	x	x	x	x	x	122,67	125,56	226,70
<b>315</b>	x	x	x	x	x	x	x	x	x	x	216,40

Wykonanie z: blachy stalowej ocynkowanej - w klasie ocynku Z275, minimalna masa powłoki obustronnie 275 g/m<sup>2</sup>, zgodnie z PN-EN 10346.

Completed out of: galvanized steel - in class Z275, min. mass of two-sided zinc coat 275 g/m<sup>2</sup> according to the PN-EN 10346.



**Redukcja tłoczona mufowo-nyplowa SAFE bez uszczelki**

• Pressed male-female reducer without gasket

**RCF**

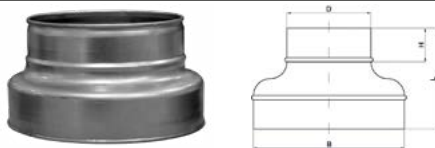

øD [mm]	Cena [PLN/szt.] • Price [PLN/pc]						
	øB [mm]						
	100	125	150	160	200	250	315
80	27,09	35,43	x	x	x	x	x
100	x	30,28	42,33	36,77	44,91	x	x
125	x	x	33,17	37,39	43,88	x	x
150	x	x	x	x	53,97	x	x
160	x	x	x	x	45,84	64,79	84,87
200	x	x	x	x	x	64,79	84,87
250	x	x	x	x	x	x	84,87

**Redukcja tłoczona mufowo-nyplowa z uszczelką**

• Pressed male-female reducer with gasket

**RCFPL**



øD [mm]	Cena [PLN/szt.] • Price [PLN/pc]						
	øB [mm]						
	100	125	150	160	200	250	315
80	34,51	47,17	x	x	x	x	x
100	x	38,42	53,97	44,91	53,35	x	x
125	x	x	53,97	46,14	53,05	x	x
150	x	x	x	x	60,77	x	x
160	x	x	x	x	54,90	73,54	96,92
200	x	x	x	x	x	73,54	96,92
250	x	x	x	x	x	x	96,92

Wykonanie z: blachy stalowej ocynkowanej - w klasie ocynku Z275, minimalna masa powłoki obustronnie 275 g/m<sup>2</sup>, zgodnie z PN-EN 10346.

Completed out of: galvanized steel - in class Z275, min. mass of two-sided zinc coat 275 g/m<sup>2</sup> according to the PN-EN 10346.



## Redukcja symetryczna bez uszczelki

• Symmetric hand made reducer without gasket

**RCLE**



ød [mm]	Cena [PLN/szt.] • Price [PLN/pc]				
	øD [mm]				
	400	500	630	800	1000
160	91,98	129,88	x	x	x
200	91,98	126,79	190,96	x	x
250	91,98	123,60	180,66	x	x
315	91,98	120,41	173,25	290,67	x
355	91,98	117,21	173,25	279,54	x
400	x	117,21	169,44	272,13	455,67
450	x	117,21	169,44	272,13	455,67
500	x	x	166,04	264,61	417,77
630	x	x	x	260,90	379,76
800	x	x	x	x	341,86

## Redukcja symetryczna z uszczelką • Symmetric hand made reducer with gasket

**RCLL**



ød [mm]	Cena [PLN/szt.] • Price [PLN/pc]				
	øD [mm]				
	400	500	630	800	1000
160	138,02	189,62	x	x	x
200	138,02	186,95	273,05	x	x
250	138,02	184,16	264,40	x	x
315	138,02	181,80	261,31	376,77	x
355	138,02	179,22	258,32	367,20	x
400	x	179,12	255,44	360,81	510,78
450	x	179,12	255,23	360,81	510,78
500	x	x	252,45	354,42	482,14
630	x	x	x	351,13	478,85
800	x	x	x	x	447,02

Wykonanie z: blachy stalowej ocynkowanej - w klasie ocynku Z275, minimalna masa powłoki obustronnie 275 g/m<sup>2</sup>, zgodnie z PN-EN 10346.

Completed out of: galvanized steel - in class Z275, min. mass of two-sided zinc coat 275 g/m<sup>2</sup> according to the PN-EN 10346.



## Redukcja niesymetryczna bez uszczelki

• Eccentric hand made reducer without gasket

**RLE**



ød [mm]	Cena [PLN/szt.] • Price [PLN/pc]				
	øD [mm]				
	400	500	630	800	1000
160	114,54	161,81	x	x	x
200	114,54	157,80	264,20	x	x
250	114,54	153,88	249,88	x	x
315	114,54	149,97	239,68	355,35	x
355	114,54	146,05	239,68	341,75	x
400	x	144,20	234,43	332,69	557,23
450	x	x	234,43	332,69	557,23
500	x	x	229,59	323,52	510,67
630	x	x	x	318,89	464,32
800	x	x	x	x	417,87

## Redukcja niesymetryczna z uszczelką

• Eccentric hand made reducer with gasket

**RLL**



ød [mm]	Cena [PLN/szt.] • Price [PLN/pc]				
	øD [mm]				
	400	500	630	800	1000
160	168,41	236,08	x	x	x
200	168,41	232,88	343,40	x	x
250	168,41	229,28	332,48	x	x
315	168,41	226,39	328,57	460,62	x
355	168,41	223,10	324,86	448,87	x
400	x	221,76	321,36	441,05	636,44
450	x	x	320,85	441,05	636,44
500	x	x	317,34	433,22	600,70
630	x	x	x	429,41	596,68
800	x	x	x	x	556,92

Wykonanie z: blachy stalowej ocynkowanej - w klasie ocynku Z275, minimalna masa powłoki obustronnie 275 g/m<sup>2</sup>, zgodnie z PN-EN 10346.

Completed out of: galvanized steel - in class Z275, min. mass of two-sided zinc coat 275 g/m<sup>2</sup> according to the PN-EN 10346.



## Redukcja symetryczna bez uszczelki (stal kwasoodporna)

• Symmetric hand made reducer without gasket (stainless steel)

**RCLE-S**



ød [mm]	Cena [PLN/szt.] • Price [PLN/pc]							
	øD [mm]							
	125	160	200	250	315	400	500	630
100	148,73	154,71	206,72	x	x	x	x	x
125	x	150,38	206,72	270,48	x	x	x	x
160	x	x	197,25	270,48	361,74	386,35	545,59	x
200	x	x	x	270,48	361,74	386,35	532,41	802,16
250	x	x	x	x	358,85	386,35	518,91	758,49
315	x	x	x	x	x	386,35	505,73	727,90
400	x	x	x	x	x	x	492,34	711,73
450	x	x	x	x	x	x	492,34	711,73
500	x	x	x	x	x	x	x	697,21

## Trójnik symetryczny bez uszczelki • T-piece without gasket

**TCPE**

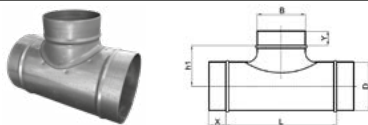

øB [mm]	Cena [PLN/szt.] • Price [PLN/pc]									
	øD [mm]									
	100	125	160	200	250	315	400	500	630	800
80	40,07	41,61	43,16	47,17	x	x	x	x	x	x
100	40,48	42,54	43,88	53,97	62,11	77,87	x	x	x	x
125	x	44,39	47,79	56,14	66,13	81,68	112,27	x	x	x
160	x	x	68,39	66,13	76,32	85,28	116,91	149,14	184,58	292,73
200	x	x	x	73,03	88,17	103,62	142,76	174,17	184,58	292,73
250	x	x	x	x	109,59	127,41	160,99	199,82	208,58	316,62
315	x	x	x	x	x	173,56	194,88	256,47	264,40	352,47
400	x	x	x	x	x	x	260,49	318,37	347,73	382,34
500	x	x	x	x	x	x	x	399,74	413,24	436,10
630	x	x	x	x	x	x	x	x	536,32	570,41

Wykonanie z: blachy stalowej ocynkowanej - w klasie ocynku Z275, minimalna masa powłoki obustronnie 275 g/m<sup>2</sup>, zgodnie z PN-EN 10346; ze stali kwasoodpornej - 1.4301 EN 10088.

Completed out of: galvanized steel - in class Z275, min. mass of two-sided zinc coat 275 g/m<sup>2</sup> according to the PN-EN 10346; stainless steel - 1.4301 EN 10088.



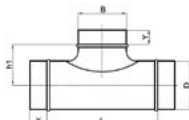

**Trójnik symetryczny z uszczelką • T-piece with gasket**
**TCPL**

øB [mm]	Cena [PLN/szt.] • Price [PLN/pc]									
	øD [mm]									
	100	125	160	200	250	315	400	500	630	800
80	64,48	66,23	71,28	100,63	x	x	x	x	x	x
100	64,48	66,23	71,28	78,28	96,51	123,09	x	x	x	x
125	x	67,77	77,97	87,76	100,63	127,21	216,71	x	x	x
160	x	x	91,57	98,57	115,57	151,82	216,71	248,64	263,78	418,08
200	x	x	x	111,96	133,39	176,54	216,71	248,64	263,78	418,08
250	x	x	x	x	158,00	217,54	270,89	285,52	298,08	452,17
315	x	x	x	x	x	254,51	343,20	366,27	377,70	503,46
400	x	x	x	x	x	x	401,80	454,75	496,67	546,00
500	x	x	x	x	x	x	x	571,03	590,29	622,84
630	x	x	x	x	x	x	x	x	766,11	814,83

**Trójnik symetryczny bez uszczelki (stal kwasoodporna)**

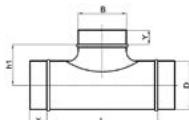
• T-piece without gasket (stainless steel)

**TCPE-S**

øB [mm]	Cena [PLN/szt.] • Price [PLN/pc]									
	øD [mm]									
	100	125	160	200	250	315	400	500	630	
100	181,38	190,45	193,43	237,42	273,16	342,68	x	x	x	
125	x	198,79	214,24	246,79	290,56	359,16	471,64	x	x	
160	x	x	306,43	295,92	335,78	375,33	490,90	626,34	775,49	
200	x	x	x	327,23	395,11	455,88	599,77	731,30	775,49	
250	x	x	x	x	490,90	570,93	676,20	839,55	876,43	
315	x	x	x	x	x	777,75	818,44	1 077,07	1 110,34	
400	x	x	x	x	x	x	1 094,07	1 337,35	1 460,44	
500	x	x	x	x	x	x	x	1 679,00	1 735,65	
630	x	x	x	x	x	x	x	x	2 252,61	

Średnice na zamówienie • On request: ø140, ø224, ø280, ø300, ø350, ø355, ø560, ø710, ø900.

 Wykonanie z: blachy stalowej ocynkowanej - w klasie ocynku Z275, minimalna masa powłoki obustronnie 275 g/m<sup>2</sup>, zgodnie z PN-EN 10346; ze stali kwasoodpornej - 1.4301 EN 10088.

 Completed out of: galvanized steel - in class Z275, min. mass of two-sided zinc coat 275 g/m<sup>2</sup> according to the PN-EN 10346; stainless steel - 1.4301 EN 10088.



**Trójnik symetryczny tłoczony SAFE bez uszczelki**

• Pressed T-piece without gasket

**TSHF**

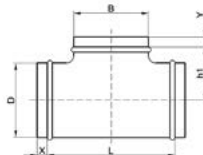

ød <sub>3</sub> [mm]	Cena [PLN/szt.] • Price [PLN/pc]					
	ød <sub>1</sub> [mm]					
	100	125	160	200	250	315
80	41,30	46,56	x	x	x	x
100	44,81	48,82	54,08	x	x	x
125	x	54,59	61,70	x	x	x
160	x	x	72,00	79,10	x	x
200	x	x	x	90,64	x	x
250	x	x	x	x	152,23	x
315	x	x	x	x	x	212,70

**Trójnik symetryczny tłoczony z uszczelką • Pressed T-piece with gasket**

**TSHFL**

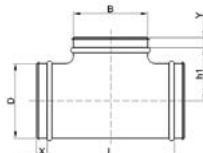

ød <sub>3</sub> [mm]	Cena [PLN/szt.] • Price [PLN/pc]					
	ød <sub>1</sub> [mm]					
	100	125	160	200	250	315
80	64,58	70,35	x	x	x	x
100	69,73	72,72	78,49	x	x	x
125	x	81,99	87,86	x	x	x
160	x	x	102,90	115,05	x	x
200	x	x	x	127,82	x	x
250	x	x	x	x	205,69	x
315	x	x	x	x	x	277,79

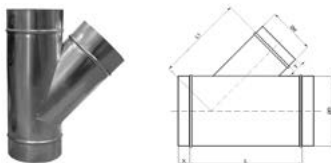
**Trójnik z odejściem pod kątem 45° bez uszczelki • 45° T-piece without gasket**
**TVE 45**

ød [mm]	Cena [PLN/szt.] • Price [PLN/pc]									
	øD [mm]									
	100	125	150	160	200	250	315	400	500	630
100	81,78	88,89	102,28	106,30	118,04	128,75	163,46	x	x	x
125	x	102,18	119,38	121,64	124,12	134,21	168,41	223,30	x	x
150	x	x	128,54	128,54	134,42	141,11	174,79	237,62	x	x
160	x	x	x	136,48	142,76	147,19	182,83	251,01	x	x
200	x	x	x	x	153,68	163,77	208,47	270,58	313,74	395,42
250	x	x	x	x	x	187,46	226,29	291,80	349,79	419,83
315	x	x	x	x	x	x	277,28	364,83	387,49	507,79
400	x	x	x	x	x	x	x	401,08	493,16	540,96
500	x	x	x	x	x	x	x	x	707,51	764,05
630	x	x	x	x	x	x	x	x	x	1 014,96

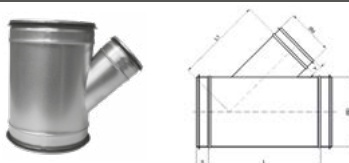
**Trójnik z odejściem pod kątem 45° z uszczelką • 45° T-piece with gasket**
**TVL 45**

ød [mm]	Cena [PLN/szt.] • Price [PLN/pc]									
	øD [mm]									
	100	125	150	160	200	250	315	400	500	630
100	102,28	111,14	127,93	132,87	147,39	160,78	204,15	x	x	x
125	x	127,72	149,25	152,13	155,22	167,89	210,43	279,13	x	x
150	x	x	160,68	160,68	168,10	176,54	218,46	296,95	x	x
160	x	x	x	170,57	178,50	183,96	228,56	313,74	x	x
200	x	x	x	x	192,20	204,66	260,69	338,25	392,12	494,30
250	x	x	x	x	x	234,22	282,84	364,83	437,24	524,89
315	x	x	x	x	x	x	346,60	455,98	484,31	634,58
400	x	x	x	x	x	x	x	501,40	616,46	676,20
500	x	x	x	x	x	x	x	x	884,46	955,12
630	x	x	x	x	x	x	x	x	x	1 268,86



Trójnik orłowy bez uszczelki • Twin bend without gasket

YVE



øD1 [mm]	Cena [PLN/szt.] • Price [PLN/pc]					
	øD [mm]					
	100	125	150	160	200	250
<b>α=45°</b>						
100	48,10	56,86	65,10	72,62	85,18	104,96
125	×	52,84	70,04	74,98	91,77	118,14
160	×	×	73,85	85,70	99,50	126,79
200	×	×	×	77,04	111,96	144,41
250	×	×	×	×	108,25	150,90
315	×	×	×	×	×	156,25
<b>α=90°</b>						
100	43,67	51,71	59,23	66,02	77,56	95,38
125	×	48,10	63,65	68,19	83,53	107,33
160	×	×	67,16	77,87	90,43	115,26
200	×	×	×	69,94	101,76	131,22
250	×	×	×	×	98,47	137,09
315	×	×	×	×	×	142,14
<b>α=120°</b>						
100	39,35	46,56	53,35	59,33	69,73	85,90
125	×	43,26	57,37	61,29	75,19	96,61
160	×	×	60,46	70,04	81,47	103,72
200	×	×	×	62,93	91,57	118,14
250	×	×	×	×	88,58	123,39
315	×	×	×	×	×	127,93

Średnice na zamówienie • On request: ø140, ø224, ø280, ø300, ø350, ø355, ø560, ø630.

Wykonanie z: blachy stalowej ocynkowanej - w klasie ocynku Z275, minimalna masa powłoki obustronnie 275 g/m<sup>2</sup>, zgodnie z PN-EN 10346.

Completed out of: galvanized steel - in class Z275, min. mass of two-sided zinc coat 275 g/m<sup>2</sup> according to the PN-EN 10346.



## Trójnik orłowy z uszczelką - Twin bend with gasket

YVL



øD1 [mm]	Cena [PLN/szt.] - Price [PLN/pc]					
	øD [mm]					
	100	125	150	160	200	250
<b>α=45°</b>						
100	72,92	86,11	98,67	110,00	129,16	159,03
125	×	80,13	106,19	113,61	139,05	178,81
160	×	×	111,96	129,78	150,69	192,10
200	×	×	×	116,60	169,54	218,57
250	×	×	×	×	163,98	228,45
315	×	×	×	×	×	236,69
<b>α=90°</b>						
100	66,23	78,28	89,61	99,91	117,32	144,51
125	×	72,92	96,51	103,31	126,38	162,53
160	×	×	101,76	118,04	136,89	174,59
200	×	×	×	105,88	154,09	198,69
250	×	×	×	×	149,04	207,75
315	×	×	×	×	×	215,27
<b>α=120°</b>						
100	59,64	70,45	80,75	90,02	105,68	129,99
125	×	65,51	86,83	92,91	113,82	146,36
160	×	×	91,57	106,19	123,29	157,18
200	×	×	×	95,38	138,74	178,81
250	×	×	×	×	134,11	186,84
315	×	×	×	×	×	193,74

Średnice na zamówienie - On request: ø140, ø224, ø280, ø300, ø350, ø355, ø560, ø630.

Wykonanie z: blachy stalowej ocynkowanej - w klasie ocynku Z275, minimalna masa powłoki obustronnie 275 g/m<sup>2</sup>, zgodnie z PN-EN 10346.Completed out of: galvanized steel - in class Z275, min. mass of two-sided zinc coat 275 g/m<sup>2</sup> according to the PN-EN 10346.



Sztucer siodłowy SAFE bez uszczelki - Collar saddle without gasket

PS / PSE



øD1 [mm]	Cena [PLN/szt.] • Price [PLN/pc]									
	øD [mm]									
	80	100	125	150	160	200	250	315	400	500
80	26,88	26,88	26,88	x	26,88	26,88	26,88	x	x	x
100	x	27,30	27,30	x	27,30	27,30	27,30	27,30	48,20	48,20
125	x	x	34,20	x	34,20	34,20	34,20	34,20	x	34,20
150	x	x	x	46,25	x	46,25	46,25	46,25	x	x
160	x	x	x	x	48,82	48,82	48,82	48,82	48,82	65,30
200	x	x	x	x	x	65,30	65,30	65,30	65,30	x
250	x	x	x	x	x	x	93,11	82,40	79,00	x
315	x	x	x	x	x	x	x	130,30	113,61	x

Sztucer siodłowy z uszczelką - Collar saddle with gasket

PSL

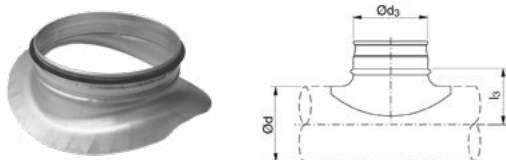

øD1 [mm]	Cena [PLN/szt.] • Price [PLN/pc]									
	øD [mm]									
	80	100	125	150	160	200	250	315	400	500
80	35,74	35,74	35,74	x	35,74	35,74	35,74	x	x	x
100	x	38,42	x	x	38,42	38,42	38,42	38,42	53,25	38,42
125	x	x	44,08	x	44,08	44,08	44,08	44,08	x	44,08
150	x	x	x	53,25	x	53,25	53,25	53,25	x	x
160	x	x	x	x	59,23	59,23	59,23	59,23	59,23	74,98
200	x	x	x	x	x	77,77	74,26	74,26	71,38	x
250	x	x	x	x	x	x	103,93	95,28	92,49	x
315	x	x	x	x	x	x	x	136,37	122,98	x

Wykonanie z: blachy stalowej ocynkowanej - w klasie ocynku Z275, minimalna masa powłoki obustronnie 275 g/m<sup>2</sup>, zgodnie z PN-EN 10346.

Completed out of: galvanized steel - in class Z275, min. mass of two-sided zinc coat 275 g/m<sup>2</sup> according to the PN-EN 10346.



Sztucer z siatką • Angle take-off with mesh 45°

AVE



øD [mm]	Op. <sup>1)</sup>	Cena [PLN/ szt.] • Price [PLN/pc]	øD [mm]	Op. <sup>1)</sup>	Cena [PLN/ szt.] • Price [PLN/pc]	øD [mm]	Op. <sup>1)</sup>	Cena [PLN/ szt.] • Price [PLN/pc]
100	65	71,17	250	30	111,76	450	9	217,54
125	50	73,65	315	28	132,25	500	8	260,18
150	30	84,77	355	24	145,54	560		353,50
160	60	85,18	400	15	172,42	630		398,92
200	50	95,17						

<sup>1)</sup> Ilość [szt./opak.] • Quantity [pcs/pack.]

Sztucer, nakładka na kanał prostokątny • Flat shoes

FBE



øD [mm]	Cena [PLN/szt.] • Price [PLN/pc]	øD [mm]	Cena [PLN/szt.] • Price [PLN/pc]	øD [mm]	Cena [PLN/szt.] • Price [PLN/pc]
80	45,63	200	79,31	355	184,78
100	45,84	224	85,49	400	238,45
125	45,84	250	91,05	450	291,08
140	50,99	280	104,65	500	339,69
150	56,03	300	132,77	560	407,78
160	56,96	315	149,97	630	489,25
180	68,19				

Sztucer, nakładka na kanał okrągły • Curved boot

CBE

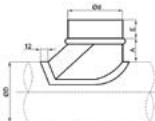

øD1 [mm]	Cena [PLN/szt.] • Price [PLN/pc]											
	øD [mm]											
	100	125	150	160	200	250	300	315	355	400	450	500
100	48,20	48,20	58,92	60,05	83,53	95,79	139,87	157,90	194,57	251,01	306,43	357,62
125	x	48,20	58,92	60,05	83,53	95,79	139,87	157,90	194,57	251,01	306,43	357,62
150	x	x	58,92	60,05	83,53	95,79	139,87	157,90	194,57	251,01	306,43	357,62
160	x	x	x	60,05	83,53	95,79	139,87	157,90	194,57	251,01	x	357,62
200	x	x	x	x	83,53	95,79	139,87	157,90	194,57	251,01	306,43	357,62
224	x	x	x	x	x	95,79	139,87	x	x	x	x	x
250	x	x	x	x	x	95,79	139,87	157,90	194,57	251,01	306,43	357,62
300	x	x	x	x	x	x	139,87	157,90	194,57	251,01	306,43	357,62
315	x	x	x	x	x	x	x	157,90	194,57	251,01	306,43	357,62

Wykonanie z: blachy stalowej ocynkowanej - w klasie ocynku Z275, minimalna masa powłoki obustronnie 275 g/m<sup>2</sup>, zgodnie z PN-EN 10346.

Completed out of: galvanized steel - in class Z275, min. mass of two-sided zinc coat 275 g/m<sup>2</sup> according to the PN-EN 10346.



## Łącznik nypłowy z uszczelką • Male connector with gasket

SSST



øD [mm]	Cena [PLN/szt.] • Price [PLN/pc]
80	9,37
100	8,45
125	8,55
140	9,89
150	9,27
160	9,58
175	12,26
180	12,26
200	12,05
224	14,42
250	14,52
280	16,89
300	17,82
315	17,92

øD [mm]	Cena [PLN/szt.] • Price [PLN/pc]
350	20,19
355	20,19
400	26,06
450	27,81
500	29,97
560	32,65
600	45,84
630	47,59
710	52,43
800	68,50
900	79,31
1000	110,73
1120	134,52
1250	142,55

Wykonanie z: blachy stalowej ocynkowanej - w klasie ocynku Z275, minimalna masa powłoki obustronnie 275 g/m<sup>2</sup>, zgodnie z PN-EN 10346.

Completed out of: galvanized steel - in class Z275, min. mass of two-sided zinc coat 275 g/m<sup>2</sup> according to the PN-EN 10346.





## Nyple teleskopowy • Telescopic male coupling

SNPL



L [mm]	150	300	500
øD [mm]	Cena [PLN/szt.] • Price [PLN/pc]		
80	51,29	71,79	100,63
100	51,29	71,79	100,63
125	53,15	74,37	104,13
140	54,18	75,81	106,19
150	54,90	77,04	107,74
160	55,62	77,77	108,87
180	62,62	87,76	122,78
200	72,00	100,84	141,01
224	78,59	110,11	154,09
250	85,28	119,38	167,17
280	103,31	144,51	202,40
300	115,15	161,30	225,78
315	124,12	173,76	243,39
355	143,58	201,06	281,40
400	177,68	248,75	348,24
450	184,99	258,84	362,46
500	192,10	268,93	376,47
560	245,66	343,81	481,42
630	299,11	418,80	586,17



## Nyple bez uszczelki • Male coupling without gasket

NP / NPE\*\*)

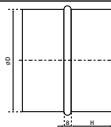

øD [mm]	Op. <sup>1)</sup> NP/NPE		Cena [PLN/szt.] • Price [PLN/pc]
80	80	70	11,33
100	100	112	11,33
125	70	72	11,33
150	75	50	11,33
160	65	70	11,95
180	55	60	13,18
200	40	54	14,52
224		45	15,86
250	55	72	17,30

øD [mm]	Op. <sup>1)</sup> NP/NPE		Cena [PLN/szt.] • Price [PLN/pc]
315		46	23,69
355		55	25,44
400		50	31,83
500		24	45,22
630		16	63,24
710		15	87,45
800		10	111,76
1000			173,56
1250			231,54

## Nyple z uszczelką • Male coupling with gasket

NPL

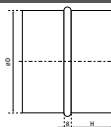

øD [mm]	Op. <sup>1)</sup>	Cena [PLN/szt.] • Price [PLN/pc]
100	90	25,65
125	60	25,65
150	45	25,65
160	60	27,81
180	50	31,42
200	40	36,05
224	30	39,35
250	55	42,64

øD [mm]	Op. <sup>1)</sup>	Cena [PLN/szt.] • Price [PLN/pc]
355	55	71,79
400	50	88,89
500	24	96,00
630	16	149,56
710		165,21
800	10	180,97
1000		291,08
1250		393,46

<sup>1)</sup> Ilość [szt./opak.] • Quantity [pcs/pack.]

\*\*) Dla średnic powyżej ø250 - wykonanie tylko NPE • for sizes above ø250 - NPE execution only

Wykonanie z: blachy stalowej ocynkowanej - w klasie ocynku Z275, minimalna masa powłoki obustronnie 275 g/m<sup>2</sup>, zgodnie z PN-EN 10346.

Completed out of: galvanized steel - in class Z275, min. mass of two-sided zinc coat 275 g/m<sup>2</sup> according to the PN-EN 10346.



## Mufa • Female coupling

MF / MFE\*\*

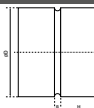

øD [mm]	Op. <sup>1)</sup>		Cena [PLN/szt.] • Price [PLN/pc]
	MF	MFE	
80	80	70	11,33
100	100	112	11,33
125	60	72	11,33
150	70	50	11,33
160	60	70	11,95
180	50	60	13,18
200	35	54	14,52
224		45	15,86
250	50	72	17,30

øD [mm]	Op. <sup>1)</sup>		Cena [PLN/szt.] • Price [PLN/pc]
	MF	MFE	
315		46	23,69
355		55	25,44
400		50	31,83
500		24	45,22
630		16	63,24
710		15	87,45
800		10	111,76
1000			173,56
1250			231,54

## Nypel bez uszczelki i mufa ze stali kwasoodpornej • Male coupling without gasket and female coupling (stainless steel)

NPE-S / MFE-S

NPE-S



MFE-S

øD [mm]	Cena [PLN/szt.] • Price [PLN/pc]
100	45,84
125	45,84
160	45,84
200	56,03
250	61,29
315	80,44
355	109,80
400	137,40
500	195,60
630	273,67

øD [mm]	Cena [PLN/szt.] • Price [PLN/pc]
100	45,84
125	45,84
160	45,84
200	56,03
250	61,29
315	80,44
355	109,80
400	137,40
500	195,60
630	273,67

<sup>1)</sup> Ilość [szt./opak.] • Quantity [pcs/pack.]

<sup>2)</sup> Dla średnic powyżej ø250 - wykonanie tylko MFE • for sizes above ø250 - MFE execution only

Wykonanie z: blachy stalowej ocynkowanej - w klasie ocynku Z275, minimalna masa powłoki obustronnie 275 g/m<sup>2</sup>, zgodnie z PN-EN 10346; ze stali kwasoodpornej - 1.4301 EN 10088.

Completed out of: galvanized steel - in class Z275, min. mass of two-sided zinc coat 275 g/m<sup>2</sup> according to the PN-EN 10346; stainless steel - 1.4301 EN 10088.



## Zaślepka przewodu • Duct end cap

ES



øD [mm]	Op. <sup>1)</sup>	Cena [PLN/szt.] • Price [PLN/pc]
<b>80</b>	150	10,71
<b>100</b>	100	14,11
<b>125</b>	70	15,04
<b>140</b>		18,44
<b>150</b>	50	16,69

øD [mm]	Op. <sup>1)</sup>	Cena [PLN/szt.] • Price [PLN/pc]
<b>160</b>	50	16,69
<b>180</b>		19,16
<b>200</b>	30	19,16
<b>224</b>		27,81
<b>250</b>	20	28,12

øD [mm]	Op. <sup>1)</sup>	Cena [PLN/szt.] • Price [PLN/pc]
<b>280</b>		40,99
<b>300</b>		42,33
<b>315</b>	20	44,91
<b>355</b>	15	57,47
<b>400</b>	15	66,23

## Zaślepka przewodu z uszczelką • Duct end cap with gasket

ESL



øD [mm]	Op. <sup>1)</sup>	Cena [PLN/szt.] • Price [PLN/pc]
<b>80</b>	80	29,25
<b>100</b>	110	29,25
<b>125</b>	72	30,18
<b>150</b>	50	30,90

øD [mm]	Op. <sup>1)</sup>	Cena [PLN/szt.] • Price [PLN/pc]
<b>160</b>	40	31,52
<b>180</b>		36,15
<b>200</b>	50	38,32
<b>224</b>		120,41

øD [mm]	Op. <sup>1)</sup>	Cena [PLN/szt.] • Price [PLN/pc]
<b>250</b>	25	59,74
<b>315</b>	25	80,75
<b>355</b>	20	93,52
<b>400</b>	20	119,79

## Zaślepka przewodu z uszczelką i rączką • Duct end cap with gasket and handle

ESLH



øD [mm]	Op. <sup>1)</sup>	Cena [PLN/szt.] • Price [PLN/pc]
<b>80</b>	80	39,76
<b>100</b>	110	39,76
<b>125</b>	72	40,99
<b>140</b>		73,44
<b>150</b>	50	41,72

øD [mm]	Op. <sup>1)</sup>	Cena [PLN/szt.] • Price [PLN/pc]
<b>160</b>	40	42,23
<b>180</b>		46,56
<b>200</b>	50	48,72
<b>224</b>		104,44
<b>250</b>	25	68,91

øD [mm]	Op. <sup>1)</sup>	Cena [PLN/szt.] • Price [PLN/pc]
<b>280</b>		146,26
<b>300</b>		146,26
<b>315</b>	25	89,40
<b>355</b>	20	101,35
<b>400</b>	20	126,69

<sup>1)</sup> Ilość [szt./opak.] • Quantity [pcs/pack.]

Wykonanie z: blachy stalowej ocynkowanej - w klasie ocynku Z275, minimalna masa powłoki obustronnie 275 g/m<sup>2</sup>, zgodnie z PN-EN 10346.

Completed out of: galvanized steel - in class Z275, min. mass of two-sided zinc coat 275 g/m<sup>2</sup> according to the PN-EN 10346.



## Zaślepka kształtki • Fitting end cap

EPF



øD [mm]	Op. <sup>1)</sup>	Cena [PLN/szt.] • Price [PLN/pc]
<b>80</b>	75	18,03
<b>100</b>	55	18,75
<b>125</b>	80	23,28
<b>150</b>	55	25,54
<b>160</b>	45	25,75
<b>180</b>		28,43
<b>200</b>	40	30,39
<b>250</b>	30	41,10

øD [mm]	Op. <sup>1)</sup>	Cena [PLN/szt.] • Price [PLN/pc]
<b>315</b>	22	56,55
<b>355</b>	25	77,87
<b>400</b>	12	82,50
<b>500</b>		116,29
<b>630</b>		136,37
<b>800</b>		211,36
<b>1000</b>		286,24

## Zaślepka kształtki z rączką • Fitting end cap with handle

EPFH



øD [mm]	Op. <sup>1)</sup>	Cena [PLN/szt.] • Price [PLN/pc]
<b>80</b>	75	27,50
<b>100</b>	55	27,50
<b>125</b>	80	32,24
<b>150</b>	55	34,30
<b>160</b>	45	36,98
<b>180</b>		41,20

øD [mm]	Op. <sup>1)</sup>	Cena [PLN/szt.] • Price [PLN/pc]
<b>200</b>	40	42,85
<b>250</b>	30	53,25
<b>315</b>	22	70,14
<b>355</b>	25	82,50
<b>400</b>	12	90,74

<sup>1)</sup> Ilość [szt./opak.] • Quantity [pcs/pack.]

Wykonanie z: blachy stalowej ocynkowanej - w klasie ocynku Z275, minimalna masa powłoki obustronnie 275 g/m<sup>2</sup>, zgodnie z PN-EN 10346.

Completed out of: galvanized steel - in class Z275, min. mass of two-sided zinc coat 275 g/m<sup>2</sup> according to the PN-EN 10346.



## Sztucer cylindryczny prosty bez uszczelki • Flat take-off without gasket

ILE



øD [mm]	Op. <sup>1)</sup>	Cena [PLN/szt.] • Price [PLN/pc]
80	100	10,61
100	150	11,12
125	100	11,12
150	100	11,12
160	100	11,74
180	50	13,08
200	75	14,32
250	40	18,85

øD [mm]	Op. <sup>1)</sup>	Cena [PLN/szt.] • Price [PLN/pc]
315	30	25,65
355	28	28,02
400	35	32,45
500	60	44,08
630	40	64,99
800		110,93
1000		140,08

## Sztucer cylindryczny prosty z uszczelką • Flat take-off with gasket

ILL



øD [mm]	Op. <sup>1)</sup>	Cena [PLN/szt.] • Price [PLN/pc]
80	100	16,69
100	150	20,81
125	100	24,93
150	70	29,77
160	100	31,62
180	50	33,06
200	75	34,81
250	50	36,57

øD [mm]	Op. <sup>1)</sup>	Cena [PLN/szt.] • Price [PLN/pc]
315	40	40,38
355	32	44,19
400	45	45,11
500	25	69,42
630	34	107,12
800		176,54
1000		231,13

<sup>1)</sup> Ilość [szt./opak.] • Quantity [pcs/pack.]

Wykonanie z: blachy stalowej ocynkowanej - w klasie ocynku Z275, minimalna masa powłoki obustronnie 275 g/m<sup>2</sup>, zgodnie z PN-EN 10346.

Completed out of: galvanized steel - in class Z275, min. mass of two-sided zinc coat 275 g/m<sup>2</sup> according to the PN-EN 10346.



## Sztucer cylindryczny pod kątem 45° bez uszczelki

• 45° flat take-off without gasket

**ILE 45**



øD [mm]	Cena [PLN/szt.] • Price [PLN/pc]
80	19,67
100	20,91
125	22,97
140	23,18
150	23,18
160	26,37
180	31,83
200	35,74
224	39,55
250	51,09

øD [mm]	Cena [PLN/szt.] • Price [PLN/pc]
280	61,39
300	65,41
315	68,60
355	79,52
400	129,47
450	139,87
500	149,25
560	161,61
630	278,00

## Sztucer cylindryczny pod kątem 45° z uszczelką

• 45° flat take-off with gasket

**ILL 45**



øD [mm]	Cena [PLN/szt.] • Price [PLN/pc]
80	31,52
100	33,37
125	36,67
140	37,08
150	37,08
160	42,33
180	50,88
200	57,06
224	63,24
250	81,68

øD [mm]	Cena [PLN/szt.] • Price [PLN/pc]
280	98,16
300	104,65
315	109,70
355	127,21
400	207,24
450	223,72
500	238,75
560	258,53
630	444,65

Wykonanie z: blachy stalowej ocynkowanej - w klasie ocynku Z275, minimalna masa powłoki obustronnie 275 g/m<sup>2</sup>, zgodnie z PN-EN 10346.

Completed out of: galvanized steel - in class Z275, min. mass of two-sided zinc coat 275 g/m<sup>2</sup> according to the PN-EN 10346.



## Sztucer cylindryczny prosty tłoczony SAFE bez uszczelki

• Pressed straight branching without gasket

ILR



øD [mm]	Op. <sup>1)</sup>	Cena [PLN/szt.] • Price [PLN/pc]
80	192	15,86
100	160	19,47
125	99	23,07

øD [mm]	Op. <sup>1)</sup>	Cena [PLN/szt.] • Price [PLN/pc]
150	70	27,30
160	75	30,18
200	36	36,26

øD [mm]	Op. <sup>1)</sup>	Cena [PLN/szt.] • Price [PLN/pc]
250	40	43,05
315	22	54,80

## Sztucer cylindryczny prosty tłoczony z uszczelką

• Pressed straight branching with gasket

ILRL



øD [mm]	Op. <sup>1)</sup>	Cena [PLN/szt.] • Price [PLN/pc]
80	40	27,91
100	40	32,14
125	50	36,57

øD [mm]	Op. <sup>1)</sup>	Cena [PLN/szt.] • Price [PLN/pc]
150	45	41,72
160	50	47,48
200	50	52,12

øD [mm]	Op. <sup>1)</sup>	Cena [PLN/szt.] • Price [PLN/pc]
250	70	64,07
315	44	77,25

## Sztucer cylindryczny prosty osiatkowany • Net straight branching

ESNE



øD [mm]	Op. <sup>1)</sup>	Cena [PLN/szt.] • Price [PLN/pc]
80	65	65,20
100	40	65,20
125	63	65,20
150	40	66,44
160	35	66,44

øD [mm]	Op. <sup>1)</sup>	Cena [PLN/szt.] • Price [PLN/pc]
180	35	67,47
200	50	76,84
250	30	90,95
315	20	103,00
355	20	112,27

øD [mm]	Op. <sup>1)</sup>	Cena [PLN/szt.] • Price [PLN/pc]
400	20	122,47
500	25	160,58
630		218,67
800		274,60

<sup>1)</sup> Ilość [szt./opak.] • Quantity [pcs/pack.]

Wykonanie z: blachy stalowej ocynkowanej - w klasie ocynku Z275, minimalna masa powłoki obustronnie 275 g/m<sup>2</sup>, zgodnie z PN-EN 10346.

Completed out of: galvanized steel - in class Z275, min. mass of two-sided zinc coat 275 g/m<sup>2</sup> according to the PN-EN 10346.





## Przewód półelastyczny aluminiowy • Semi-rigid aluminium duct

## S-FLEX

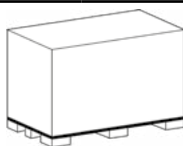

**P1**  
L×B×H - 1200 × 800 × 800 (mm)  
opak./paleta - od 1 do 3  
• pack./palette - from 1 to 3

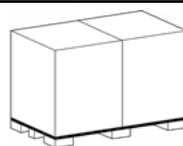

**P2**  
L×B×H - 600 × 800 × 800 (mm)  
opak./paleta - od 2 do 6  
• pack./palette - from 2 to 6

øD [mm]	Na sztuki • Per piece		Opakowanie kartonowe P1 • Cardboard box P1				Opakowanie kartonowe P2 • Cardboard box P2			
	Cena • Price [PLN]		Cena • Price [PLN]		Ilość • Quantity	Cena • Price [PLN]	Cena • Price [PLN]		Ilość • Quantity	Cena • Price [PLN]
	1 m	3 m	1 m	3 m	szt./opak. • pc/pack.	opak. • pack.	1 m	3 m	szt./opak. • pc/pack.	opak. • pack.
<b>80</b>	16,17	48,51	14,62	43,86	125	5 482,50	15,17	45,51	54	2 457,54
<b>100</b>	17,27	51,82	15,73	47,19	81	3 822,39	16,17	48,51	42	2 037,42
<b>120</b>	20,60	61,80	18,72	56,16	53	2 976,48				
<b>125</b>	21,49	64,46	19,49	58,47	53	3 098,91				
<b>130</b>	21,93	65,79	20,04	60,12	48	2 885,76				
<b>150</b>	24,80	74,41	22,59	67,77	38	2 575,26				
<b>160</b>	27,13	81,39	24,59	73,77	32	2 360,64				
<b>180</b>	30,23	90,69	27,57	82,71	24	1 985,04				
<b>200</b>	33,44	100,33	30,45	91,35	20	1 827,00				
<b>250</b>	42,41	127,22	38,65	115,95	13	1 507,35				
<b>315</b>	56,36	169,08								

### Opakowania zbiorcze - mix średnic • Mix boxes

D [mm]	Ilość [szt./opak.] • Quantity [pc/pack.]	Opakowanie kartonowe • Cardboard box	
<b>100 - 125 - 160</b>	32	P2	Na zamówienie • On request
<b>100 - 125 - 160 - 200</b>	20	P2	



## Przewód aluminiowy elastyczny nieizolowany

• Non-insulated aluminium flexible duct

AF-012



ØD [mm]	Op. <sup>1)</sup>	Cena / opak. • Price / pack. [PLN / 10 m]
83	325	170,96
102	320	177,39
127	238	225,66
152	156	277,04
163	156	295,08
178		327,53
203	100	352,66
229		431,83
254	64	465,60

ØD [mm]	Op. <sup>1)</sup>	Cena / opak. • Price / pack. [PLN / 10 m]
277		521,74
305	42	564,92
315	42	575,77
356	18	600,90
406	10	870,85
458	10	1 022,33
508		1 176,67
558		1 230,60
630		1 403,44

## Przewód aluminiowy elastyczny izolowany termicznie i akustycznie

• Thermally and acoustically insulated aluminium flexible duct

AF-019



ØD [mm]	Op. <sup>1)</sup>	Cena / opak. • Price / pack. [PLN / 10 m]
83	112	527,05
102	84	586,73
127	60	650,06
152	50	702,67
163	50	755,37
178	36	864,32
203	36	888,90
229	21	1 032,84
254	21	1 127,85

ØD [mm]	Op. <sup>1)</sup>	Cena / opak. • Price / pack. [PLN / 10 m]
277		1 212,10
305	18	1 317,63
315	18	1 387,83
356	18	1 486,16
406	10	1 991,39
458	10	2 116,85
508		2 246,39
558		2 469,28
630		2 955,70

## Przewód elastyczny AF-019 z dodatkową paroszczelną folią poliesterową

• AF-019 Insulated flexible duct with additional layer of perforated polyester foil

AF-013



ØD [mm]	Op. <sup>1)</sup>	Cena / opak. • Price / pack. [PLN / 10 m]
83	112	557,94
102	84	621,17
127	60	688,15
152	50	743,96
163	50	799,76
178	36	915,14
203	36	941,16
229	21	1 093,63
254	21	1 194,17

ØD [mm]	Op. <sup>1)</sup>	Cena / opak. • Price / pack. [PLN / 10 m]
277		1 283,41
305	18	1 395,02
315	18	1 469,43
356	18	1 573,62
406	10	2 108,53
458	10	2 241,52
508		2 378,60
558		2 614,55
630		3 129,64

<sup>1)</sup> Ilość [szt./paleta] • Quantity [pcs/palette]

# ELASTYCZNE PRZEWODY WENTYLACYJNE

Elastyczne przewody wentylacyjne, otulina • Aluminium flexible ducts, pipe insulation



## Przewód aluminiowy elastyczny izolowany odporny do +250°C

• Insulated aluminium duct temperature resistant to +250°C

M0izo



øD [mm]	Opakowanie [szt.] • Package [pcs]	Cena / opak. • Price / pack. [PLN / 10 m]
83		588,94
102	52	655,82
127	48	726,36
152	30	785,38
163	30	844,28
178		965,96
203	24	993,42
229		1 154,53
254	14	1 260,49
277		1 354,72
305		1 472,53
315	12	1 551,04
356	12	1 660,99
406	10	2 367,74
458	10	2 516,89
508	8	2 670,91

## Otulina 25 mm do izolacji rur, zewnętrzny zbrojony płaszcz aluminiowy

• 25 mm pipe insulation with the external reinforced aluminium coat

SLEEVE



øD [mm]	Cena / opak. • Price / pack. [PLN / 10 m]
83	Z
102	295,61
127	324,14
152	342,89
163	361,53
178	Z
203	416,02
229	Z

øD [mm]	Cena / opak. • Price / pack. [PLN / 10 m]
254	504,91
277	Z
305	Z
315	622,64
356	Z
406	Z
458	Z
508	Z

<sup>1)</sup> Ilość [szt./paleta] • Quantity [pcs/palette]

Z - cena na zapytanie • price on inquiry



## Przewód elastyczny aluminium laminowany PVC

• PVC laminated aluminium flexible duct

### COMBIFLEX



øD [mm]	Cena / opak. • Price / pack. [PLN / 10 m]
83	230,19
102	250,24
127	300,29
152	377,24
163	392,64
178	398,94
203	488,85
229	577,43

øD [mm]	Cena / opak. • Price / pack. [PLN / 10 m]
254	639,10
277	689,04
305	766,22
315	789,13
356	981,69
406	1 181,77
457	Z
508	Z

## Przewód elastyczny z PVC o podwyższonej wytrzymałości

• Reinforced PVC flexible duct

### POLYFLEX HEAVY DUTY



øD [mm]	Cena / opak. • Price / pack. [PLN / 10 m]
83	453,09
102	533,04
127	640,76
152	721,37
163	764,56
178	823,68
203	925,99
229	1 049,90

øD [mm]	Cena / opak. • Price / pack. [PLN / 10 m]
254	1 211,33
277	Z
305	1 485,93
315	1 658,22
356	1 803,60
406	2 110,53
458	2 694,60
508	3 109,04

## Tłumik elastyczny • Flexible silencers

### TAE

L = 1000 mm



øD [mm]	Cena / opak. • Price / pack. [PLN / m]
83	156,05
102	159,96
127	175,51
152	Z
163	183,44
178	Z
203	210,64
229	Z

øD [mm]	Cena / opak. • Price / pack. [PLN / m]
254	245,86
277	Z
305	Z
315	331,66
356	Z
406	417,46
458	Z
508	Z

Z - cena na zapytanie • price on inquiry



## Kanały i kształtki prostokątne typ AI • Rectangular ducts and fittings, type AI



### Standard wykonania:

- kanały z blachy ocynkowanej wg Normy DIN 24190, 24191
- II klasa szczelności wg. DIN 24194
- stopień ciśnienia 1-4 wg. DIN 24190 i 24191
- obmiar DIN 18 379.

### Standard manufacturing:

- galvanized steel ducts according to DIN 24190, 24191
- air tightness class II according to DIN 24194
- pressure level 1-4 according to DIN 24190 i 24191.

Wymiar boku • Dimension [mm]	Grubość blachy • Sheet thickness [mm]
	Klasa N • Class N
100 - 500	0,50
501 - 700	0,60
701 - 900	0,70
> 900	1,00

Nazwa • Name [mm]	Cena • Price [PLN/m <sup>2</sup> ]		
	Zamówienie • Order < 200 m <sup>2</sup>	Zamówienie • Order 200 - 500 m <sup>2</sup>	Zamówienie • Order > 500 m <sup>2</sup>
<b>Kanały (długość boku do 2500 mm)</b> • Ducts (side length up to 2500 mm)	91,46	80,13	68,70
<b>Kształtki (długość boku do 2500 mm)</b> • Fittings (side length up to 2500 mm)	105,88	94,45	82,92

### Powierzchnia przewodów wentylacyjnych

Obmiar powierzchni przewodów wentylacyjnych prostokątnych jest zgodny z normą DIN 18379.

1. Kształtka, której powierzchnia jest mniejsza niż 1,0 m<sup>2</sup>, jest liczona jako kształtka o powierzchni 1,0 m<sup>2</sup>.
2. Kanał, którego powierzchnia jest mniejsza niż 1,0 m<sup>2</sup>, jest liczony jako kształtka o powierzchni 1,0 m<sup>2</sup>.
3. Kanał prostokątny, którego długość L ≤ 900 mm jest liczony jako kształtka.
4. Standardowa długość kanałów prostokątnych L=1250 mm. W przypadku zamówień kanałów o innej długości niż standardowa, naliczana jest dodatkowa opłata w wysokości 10% ich ceny.

### Ventilation ducts surface

The surface area of rectangular ventilation ducts complies with the DIN 18379 standard.

1. A fitting with a surface area of less than 1.0 m<sup>2</sup> is calculated as a fitting surface of 1.0 m<sup>2</sup>.
2. A duct with a surface area of less than 1.0 m<sup>2</sup> is calculated as a fitting surface of 1.0 m<sup>2</sup>.
3. A rectangular duct whose length L ≤ 900mm is calculated as a fitting.
4. The standard length of rectangular ducts is L = 1250mm. In case of orders for ducts of a different length than the standard one, there is an additional fee of 10% of their price.



## System wentylacji pożarowej • Smoke control system



**Wszystkie produkty są certyfikowane w klasie odporności ogniowej E<sub>600</sub> 120 h<sub>o</sub> S1500 single.**  
 • Products are certified in class to E<sub>600</sub> 120 h<sub>o</sub> S1500 single.

Jednostrefowe kanały oddymiające: • Single compartment smoke ducts

Wymiary • Dimension	Cena • Price [PLN/m <sup>2</sup> ]
do 1250×1000 mm • to 1250x1000 mm	135,96
do 2500×1500 mm • to 2500x1500 mm	173,04

Jednostrefowe kształtki oddymiające: • Single compartment smoke fittings

Wymiary • Dimension	Cena • Price [PLN/m <sup>2</sup> ]
do 1250×1000 mm • to 1250x1000 mm	146,26
do 2500×1500 mm • to 2500x1500 mm	184,37

Oferta nie obejmuje elementów montażowych. • Mounting materials are not included.

### Powierzchnia przewodów wentylacyjnych

Obmiar powierzchni przewodów wentylacyjnych prostokątnych jest zgodny z normą DIN 18379.

1. Kształtka, której powierzchnia jest mniejsza niż 1,0 m<sup>2</sup>, jest liczona jako kształtka o powierzchni 1,0 m<sup>2</sup>.
2. Kanał, którego powierzchnia jest mniejsza niż 1,0 m<sup>2</sup>, jest liczony jako kształtka o powierzchni 1,0 m<sup>2</sup>.
3. Kanał prostokątny, którego długość L ≤ 900 mm jest liczony jako kształtka.
4. Standardowa długość kanałów prostokątnych L=1250 mm. W przypadku zamówień kanałów o innej długości niż standardowa, naliczana jest dodatkowa opłata w wysokości 10% ich ceny.

### Ventilation ducts surface

The surface area of rectangular ventilation ducts complies with the DIN 18379 standard.

1. A fitting with a surface area of less than 1.0 m<sup>2</sup> is calculated as a fitting surface of 1.0 m<sup>2</sup>.
2. A duct with a surface area of less than 1.0 m<sup>2</sup> is calculated as a fitting surface of 1.0 m<sup>2</sup>.
3. A rectangular duct whose length L ≤ 900mm is calculated as a fitting.
4. The standard length of rectangular ducts is L = 1250mm. In case of orders for ducts of a different length than the standard one, there is an additional fee of 10% of their price.



## Elastyczny przewód dwuwarstwowy • Double layer elastic duct EPD



EPD



EPD-IP

Typ • Type	Średnica • Diameter [mm]	Długość • Length [mb]	Wytrzymałość na ściskanie • Compression resistance [N]	Cena [PLN/szt.] • Price [PLN/pc]
<b>EPD×63</b>	63	50	450	680,83
<b>EPD×75</b>	75	50	450	680,83
<b>EPD×90</b>	90	50	450	828,12

<b>EPD-IP×75</b>	75	50	450	567,53
------------------	----	----	-----	--------

### Obejście przewodu proste • Duct bypass OPP



Typ • Type	Cena [PLN/szt.] • Price [PLN/pc]
<b>OPP×63</b>	113,30
<b>OPP×75</b>	113,30
<b>OPP×90</b>	135,96

### Uszczelka do przewodu • Duct sealing UPE



Typ • Type	Cena [PLN/szt.] • Price [PLN/pc]
<b>UPE×63</b>	3,50
<b>UPE×75</b>	3,50
<b>UPE×90</b>	4,53

### Łącznik do przewodu • Duct connector LPE-P



Typ • Type	Cena [PLN/szt.] • Price [PLN/pc]
<b>LPE-P×63</b>	8,03
<b>LPE-P×75</b>	8,03
<b>LPE-P×90</b>	9,06

### Mocowanie przewodu • Duct clamp MPE



Typ • Type	Cena [PLN/szt.] • Price [PLN/pc]
<b>MPE×63</b>	5,77
<b>MPE×75</b>	5,77
<b>MPE×90</b>	6,80

### Zaślepka do przewodu • Fitting end cap ZPE



Typ • Type	Cena [PLN/szt.] • Price [PLN/pc]
<b>ZPE×63</b>	3,50
<b>ZPE×75</b>	3,50
<b>ZPE×90</b>	4,53



## Rozdzielacze przelotowe dwurzędowe • Double row through manifolds

## RPD / RPDI



Typ • Type	Cena [PLN/szt.] • Price [PLN/pc]
nieizolowane	
<b>RPD-8×63/160</b>	283,87
<b>RPD-8×75/160</b>	283,87
<b>RPD-8×90/160</b>	336,09
izolowane	
<b>RPDI-8×63/160</b>	391,81
<b>RPDI-8×75/160</b>	391,81
<b>RPDI-8×90/160</b>	454,23

Typ • Type	Cena [PLN/szt.] • Price [PLN/pc]
nieizolowane	
<b>RPD-10×63/200</b>	329,29
<b>RPD-10×75/200</b>	329,29
<b>RPD-10×90/200</b>	374,71
izolowane	
<b>RPDI-10×63/200</b>	425,91
<b>RPDI-10×75/200</b>	425,91
<b>RPDI-10×90/200</b>	488,32



Typ • Type	Cena [PLN/szt.] • Price [PLN/pc]
nieizolowane	
<b>RPD-12×63/200</b>	352,05
<b>RPD-12×75/200</b>	352,05
<b>RPD-12×90/200</b>	408,81
izolowane	
<b>RPDI-12×63/200</b>	476,99
<b>RPDI-12×75/200</b>	476,99
<b>RPDI-12×90/200</b>	545,08

Typ • Type	Cena [PLN/szt.] • Price [PLN/pc]
nieizolowane	
<b>RPD-14×63/200</b>	397,48
<b>RPD-14×75/200</b>	397,48
<b>RPD-14×90/200</b>	442,90
izolowane	
<b>RPDI-14×63/200</b>	545,08
<b>RPDI-14×75/200</b>	545,08
<b>RPDI-14×90/200</b>	618,93



Typ • Type	Cena [PLN/szt.] • Price [PLN/pc]
nieizolowane	
<b>RPD-18×63/200</b>	482,66
<b>RPD-18×75/200</b>	482,66
<b>RPD-18×90/200</b>	550,84

Typ • Type	Cena [PLN/szt.] • Price [PLN/pc]
izolowane	
<b>RPDI-18×63/200</b>	658,69
<b>RPDI-18×75/200</b>	658,69
<b>RPDI-18×90/200</b>	760,86





## Rozdzielacze kątowe jednorzędowe • Single row angular manifolds

RKJ / RKJI



Typ • Type	Cena [PLN/szt.] • Price [PLN/pc]
nieizolowane	
<b>RKJ-8×63/160</b>	204,46
<b>RKJ-8×75/160</b>	204,46
<b>RKJ-8×90/160</b>	227,12
izolowane	
<b>RKJI-8×63/160</b>	261,21
<b>RKJI-8×75/160</b>	261,21
<b>RKJI-8×90/160</b>	295,30

Typ • Type	Cena [PLN/szt.] • Price [PLN/pc]
nieizolowane	
<b>RKJ-10×63/200</b>	261,21
<b>RKJ-10×75/200</b>	261,21
<b>RKJ-10×90/200</b>	306,63
izolowane	
<b>RKJI-10×63/200</b>	340,72
<b>RKJI-10×75/200</b>	340,72
<b>RKJI-10×90/200</b>	397,48



Typ • Type	Cena [PLN/szt.] • Price [PLN/pc]
nieizolowane	
<b>RKJ-12×63/200</b>	306,63
<b>RKJ-12×75/200</b>	306,63
<b>RKJ-12×90/200</b>	340,72
izolowane	
<b>RKJI-12×63/200</b>	386,15
<b>RKJI-12×75/200</b>	386,15
<b>RKJI-12×90/200</b>	442,90

Typ • Type	Cena [PLN/szt.] • Price [PLN/pc]
nieizolowane	
<b>RKJ-14×63/200</b>	329,29
<b>RKJ-14×75/200</b>	329,29
<b>RKJ-14×90/200</b>	374,71
izolowane	
<b>RKJI-14×63/200</b>	386,15
<b>RKJI-14×75/200</b>	386,15
<b>RKJI-14×90/200</b>	442,90



Typ • Type	Cena [PLN/szt.] • Price [PLN/pc]
nieizolowane	
<b>RKJ-16×63/200</b>	352,05
<b>RKJ-16×75/200</b>	352,05
<b>RKJ-16×90/200</b>	397,48

Typ • Type	Cena [PLN/szt.] • Price [PLN/pc]
izolowane	
<b>RKJI-16×63/200</b>	397,48
<b>RKJI-16×75/200</b>	397,48
<b>RKJI-16×90/200</b>	454,23

# SYSTEM WENTYLACJI ROZDZIELACZOWEJ

Rozdzielacze kątowe niesymetryczne, skrzynki rozprężne

• Asymmetric angular manifolds, plenum boxes



## Rozdzielacze kątowe niesymetryczne • Asymmetric angular manifolds

**RK / RKI**



Typ • Type	Cena [PLN/szt.] • Price [PLN/pc]
nieizolowane	
<b>RK-L-10×63/160</b>	283,87
<b>RK-L-10×75/160</b>	283,87
<b>RK-L-10×90/160</b>	329,29
izolowane	
<b>RKI-L-10×63/160</b>	369,15
<b>RKI-L-10×75/160</b>	369,15
<b>RKI-L-10×90/160</b>	425,91

Typ • Type	Cena [PLN/szt.] • Price [PLN/pc]
nieizolowane	
<b>RK-R-10×63/160</b>	283,87
<b>RK-R-10×75/160</b>	283,87
<b>RK-R-10×90/160</b>	329,29
izolowane	
<b>RKI-R-10×63/160</b>	369,15
<b>RKI-R-10×75/160</b>	369,15
<b>RKI-R-10×90/160</b>	425,91

## Skrzynki rozprężne • Plenum boxes

**SR-T**



Typ • Type	Cena [PLN/szt.] • Price [PLN/pc]
<b>SR-T1×63/100</b>	79,52
<b>SR-T1×75/100</b>	79,52
<b>SR-T1×90/100</b>	102,18

Typ • Type	Cena [PLN/szt.] • Price [PLN/pc]
<b>SR-T2×63/125</b>	90,85
<b>SR-T2×75/125</b>	90,85
<b>SR-T2×90/125</b>	113,61



Typ • Type	Cena [PLN/szt.] • Price [PLN/pc]
<b>SR-T3×63/125</b>	119,27
<b>SR-T3×75/125</b>	119,27
<b>SR-T3×90/125</b>	142,04

Typ • Type	Cena [PLN/szt.] • Price [PLN/pc]
<b>SR-T4×63/160</b>	147,60
<b>SR-T4×75/160</b>	147,60
<b>SR-T4×90/160</b>	181,69



## Przepustnica jednopłaszczyznowa okrągła bez uszczelki

• Circular duct damper without gasket

**DSE**

DSE



DSE-MPJ



DSE		
øD [mm]	Op. <sup>1)</sup>	Cena [PLN/szt.] • Price [PLN/pc]
80	60	71,59
100	40	71,59
125	27	71,59
150	30	74,68
160	24	78,49
200	36	81,99
250	48	90,02
315	35	102,79
355	30	134,21
400	15	141,21
500		177,78
630		212,08
800		312,40
1000		668,16
1250		1 118,68

DSE-MPJ	
øD [mm]	Cena [PLN/szt.] • Price [PLN/pc]
80	69,73
100	69,73
125	69,73
150	71,89
160	76,63
200	80,13
250	88,07
315	100,73
355	132,05

## Przepustnica jednopłaszczyznowa okrągła z uszczelką

• Circular duct damper with gasket

**DSL**



øD [mm]	Opakowanie [szt.] • Package [pcs]	Cena [PLN/szt.] • Price [PLN/pc]
80	60	93,01
100	40	93,01
125	27	93,01
150	30	97,03
160	24	102,07
200	36	106,61
250	48	117,01
315	35	133,59
355	30	174,48
400	15	183,65
500		210,12
630		250,70
800		369,26
1000		868,70
1250		1 454,26

<sup>1)</sup> Ilość [szt./opak.] • Quantity [pcs/pack.]



**Przepustnica jednopłaszczyznowa okrągła z uszczelką, szczelna odcinająca**  
• Circular duct damper with gasket, airtight

**DTL / DTBL**

DTL



DTBL



DTL	
øD [mm]	Cena [PLN/szt.] • Price [PLN/pc]
80	145,13
100	145,13
125	145,13
150	150,48
160	159,24
200	166,24
250	190,55
315	217,74
355	222,79
400	260,18
500	297,88
630	355,14
800	523,24
1000	1 118,99
1250	1 873,47

DTBL POD SIŁOWNIK • FOR ACTUATORS	
øD [mm]	Cena [PLN/szt.] • Price [PLN/pc]
80	174,17
100	174,17
125	174,17
150	180,46
160	191,07
200	199,41
250	228,76
315	261,21
355	267,39
400	312,19
500	357,31
630	426,21
800	627,89
1000	1 342,81
1250	2 248,18

**Przepustnica jednopłaszczyznowa okrągła (stal kwasoodporna)**

• Circular duct damper (stainless steel)

**DSE-S**

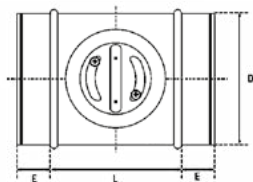

øD [mm]	Cena [PLN/szt.] • Price [PLN/pc]
100	330,73
125	330,73
160	362,77
200	378,83
250	415,61
315	474,62
400	652,61
500	821,43
630	979,84



## Przepustnica gilotynowa - Manual plate damper

GKL



øD [mm]	Cena [PLN/szt.] • Price [PLN/pc]
100	273,16
125	280,57
140	307,15
150	316,00
160	345,67
180	397,99
200	460,93
224	496,05
250	549,92
280	605,33
300	667,96
315	719,35
355	807,42
400	962,33



## Przepustnica zwrotna z uszczelką • Back draft damper with gasket

**RSK**



øD [mm]	Cena [PLN/szt.] • Price [PLN/pc]
<b>100</b>	73,65
<b>125</b>	79,41
<b>150</b>	93,11
<b>160</b>	97,23
<b>200</b>	123,60
<b>250</b>	201,78
<b>315</b>	252,14
<b>355</b>	326,20
<b>400</b>	435,90

## Przepustnica typu IRIS • IRIS damper

**IRIS**



øD [mm]	Cena [PLN/szt.] • Price [PLN/pc]
<b>100</b>	304,57
<b>125</b>	358,65
<b>150</b>	408,81
<b>160</b>	408,81
<b>200</b>	438,88
<b>250</b>	721,41
<b>300</b>	825,55
<b>315</b>	825,55
<b>400</b>	1 011,36
<b>500</b>	1 610,82
<b>630</b>	2 434,92
<b>800</b>	4 912,17



## Nastawne regulatory stałego przepływu • Flow regulators

RDR / RDR HP



Łatwa regulacja żądanej nastawy przepływu.

Trwałe ustalenie wartości przepływu powietrza ustalane za pomocą śrubokrętu „TORX 10”.

Konstrukcja z tworzywa sztucznego (M1) oraz ze stali ocynkowanej (na tulejach o średnicach od  $\varnothing 150$  do  $\varnothing 250$  mm).  
Maksymalna temperatura pracy wynosi  $60^{\circ}\text{C}$ .

*Easy adjustment.*

*The requested air flow is fixed by a screwdriver «torx n°10».*

*Made in plastic material (classified M1) and in galvanized steel for sleeves in  $\varnothing 150$  to  $\varnothing 250$  mm.*

*Use with a maximum temperature of  $60^{\circ}\text{C}$ .*

Typ • Type	Średnica • Diameter [mm]	Przepływ • Flow [m <sup>3</sup> /h]	Zakres ciśnień • Pressures range [Pa]	Cena [PLN/szt.] • Price [PLN/pc]
<b>RDR 80</b>	80	15 - 50	50 - 250	61,80
<b>RDR 100*</b>	100	50 - 100		74,16
<b>RDR 125*</b>	125	100 - 180		82,40
<b>RDR 160*</b>	160	180 - 300		123,60
<b>RDR 200*</b>	200	300 - 500		185,40
<b>RDR 250*</b>	250	450 - 800		278,10
<b>RDR HP 80</b>	80	25 - 90	150 - 600	70,04
<b>RDR HP 100</b>	100	90 - 170		82,40
<b>RDR HP 125</b>	125	180 - 300		92,70
<b>RDR HP 160</b>	160	300 - 500		139,05
<b>RDR HP 200</b>	200	500 - 850		211,15
<b>RDR HP 250</b>	250	850 - 1300		307,97

\* - dostępność z magazynu



## Przepustnica wielopłaszczyznowa aluminiowa

• Multi-leaf aluminium dampers

PW



Wykonanie: • Material:

- aluminium (obudowa + żaluzja) • aluminium cover
- tworzywo PA (kółka napędowe) • aluminium louver slats
- guma (uszczelki, żaluzja) • driving cogs made of PA material

Z uwagi na ograniczenia transportowe, jeden z wymiarów (B lub H) nie może być większy niż 2000 mm.

• Because of transport limitations one of the dimensions (B or H) cannot surpass 2000 mm.

H [mm]	Cena [PLN/szt.] • Price [PLN/pc]									
	B [mm]									
	300	400	600	800	1000	1200	1400	1600	1800	2000
<b>200</b>	197,76	211,36	238,75	266,05	293,34	457,94	545,69	658,69	699,58	775,59
<b>300</b>	276,97	296,02	334,24	372,45	410,66	641,18	736,66	888,68	943,17	997,76
<b>400</b>	315,08	338,25	384,71	431,06	476,07	746,34	853,56	1 046,48	1 112,71	1 179,04
<b>600</b>	392,84	424,26	485,65	547,03	608,42	956,87	1 085,52	1 364,13	1 451,89	1 539,54
<b>800</b>	499,34	538,90	615,22	691,65	767,97	1 208,29	1 399,26	1 722,68	1 833,81	1 942,89
<b>1000</b>	577,01	623,46	716,16	807,62	929,06	1 416,77	1 631,11	2 081,32	2 213,78	2 346,34
<b>1200</b>	935,45	1 013,31	1 167,30	1 319,33	1 514,20	1 627,30	1 863,06	2 400,93	2 552,86	2 706,84
<b>1400</b>	1 048,44	1 136,19	1 352,49	1 527,80	1 703,21	1 878,62	2 135,81	2 759,47	2 934,88	3 110,29
<b>1600</b>	1 200,47	1 297,90	1 496,69	1 693,53	1 931,25	2 128,08	2 367,76	3 077,13	3 273,96	3 511,68
<b>1800</b>	1 311,50	1 420,68	1 638,94	1 900,04	2 118,30	2 379,51	2 599,72	3 435,67	3 613,03	3 874,14
<b>2000</b>	1 422,64	1 543,46	1 824,03	2 065,67	2 348,30	2 589,94	2 831,57	3 753,32	3 993,10	4 234,64

Możliwość wykonania przepustnicy o indywidualnych wymiarach w zakresie

H=200÷2000 mm oraz B=200÷2000 mm - cena na zapytanie ofertowe

• Possible manufacturing within range H = 200-2000 and B=200-2000 - price on inquiry.





## Przepustnica wielopłaszczyznowa aluminiowa, odporna termicznie

• Temperature resistant multi-leaf aluminium damper

**PWT**



Wykonanie: • material:

- aluminium (obudowa + żaluzja) • aluminium cover
- tworzywo PA (kółka napędowe) • aluminium louver slats
- guma (uszczelki, żaluzja) • driving cogs made of PA material
- odporna termicznie • temperature resistant

Z uwagi na ograniczenia transportowe, jeden z wymiarów (B lub H) nie może być większy niż 2000 mm.

• Because of transport limitations one of the dimensions (B or H) cannot surpass 2000 mm.

H [mm]	Cena [PLN/szt.] • Price [PLN/pc]									
	B [mm]									
	300	400	600	800	1000	1200	1400	1600	1800	2000
<b>300</b>	276,97	296,02	334,24	372,45	410,66	641,18	736,66	888,68	943,17	997,76
<b>400</b>	315,08	338,25	384,71	431,06	476,07	746,34	853,56	1 046,48	1 112,71	1 179,04
<b>600</b>	392,84	424,26	485,65	547,03	608,42	956,87	1 085,52	1 364,13	1 451,89	1 539,54
<b>800</b>	499,34	538,90	615,22	691,65	767,97	1 208,29	1 399,26	1 722,68	1 833,81	1 942,89
<b>1000</b>	577,01	623,46	716,16	807,62	929,06	1 416,77	1 631,11	2 081,32	2 213,78	2 346,34
<b>1200</b>	935,45	1 013,31	1 167,30	1 319,33	1 514,20	1 627,30	1 863,06	2 400,93	2 552,86	2 706,84
<b>1400</b>	1 048,44	1 136,19	1 352,49	1 527,80	1 703,21	1 878,62	2 135,81	2 759,47	2 934,88	3 110,29
<b>1600</b>	1 200,47	1 297,90	1 496,69	1 693,53	1 931,25	2 128,08	2 367,76	3 077,13	3 273,96	3 511,68
<b>1800</b>	1 311,50	1 420,68	1 638,94	1 900,04	2 118,30	2 379,51	2 599,72	3 435,67	3 613,03	3 874,14
<b>2000</b>	1 422,64	1 543,46	1 824,03	2 065,67	2 348,30	2 589,94	2 831,57	3 753,32	3 993,10	4 234,64

Możliwość wykonania przepustnicy o indywidualnych wymiarach w zakresie

H=200÷2000 mm oraz B=200÷2000 mm - cena na zapytanie ofertowe

• Possible manufacturing within range H =200-2000 and B=200-2000 - price on inquiry.



## Przepustnica jednopłaszczyznowa • Single-leaf damper

PJ

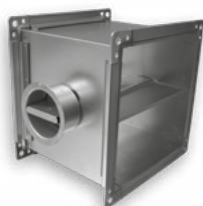

Charakterystyka produktu: • *Characteristic:*

- rama przepustnicy wykonana z profili i narożnika  
• *the damper's is made of shapes and a corner*
- rozmiar profili i narożnika zależy od przekroju  
• *size of the shapes and corner depends on the damper's section*
- standardowo wykonywany na mechanizmie SPIRO  
• *as standard manufactured with SPIRO mechanism*

Istnieje możliwość wykonania pod siłownik.

- *There is a possibility of manufacturing to allow connecting the actuator.*

H [mm]	Cena [PLN/szt.] • Price [PLN/pc]						
	B [mm]						
	160	200	250	315	400	500	630
100	100,53	101,87	104,55	107,22	112,68	119,48	146,67
160	101,87	104,85	105,88	110,00	114,12	137,20	152,13
200	104,55	105,88	108,67	112,68	119,48	145,33	152,13
250	105,88	119,48	112,68	127,62	127,62	145,33	160,27
315	111,34	120,82	127,62	127,62	135,75	154,81	162,95
400	119,48	129,06	145,33	145,33	145,33	160,27	177,88
500	127,62	145,33	146,67	152,13	160,27	211,87	225,47
630	157,49	145,33	169,74	186,02	186,02	252,56	259,35



## Przepustnica samoczynna kanałowa • Automatic duct damper

**PSK**



**Materiał** • *Material:*

- profil, żaluzja - aluminium • *shape, louver - aluminium*
- prowadnice żaluzji - tworzywo sztuczne • *louver drives - plastic*

**Wykonanie z aluminium zapobiega powstawaniu korozji.**

• *Aluminium prevents the occurrence of corrosion.*

H [mm]	Cena [PLN/szt.] • Price [PLN/pc]						
	B [mm]						
	300	400	600	800	1000	1200	1400
300	432,38	477,59	565,62	653,56	741,59	829,51	960,27
400	510,37	560,55	663,61	766,68	869,74	970,32	1 116,11
600	663,61	728,93	859,69	990,44	1 123,68	1 254,44	1 427,80
800	857,20	937,66	1 098,48	1 256,92	1 417,74	1 578,67	1 822,54
1000	1 010,55	1 106,06	1 294,56	1 483,07	1 714,39	1 860,18	2 131,64
1200	1 163,91	1 271,96	1 490,64	1 706,82	1 965,73	2 141,70	2 443,32
1400	1 317,16	1 440,46	1 726,94	1 973,30	2 219,67	2 466,04	2 797,84
1600	1 510,75	1 648,97	1 923,02	2 199,55	2 516,33	2 790,27	3 107,05
1800	1 664,11	1 817,47	2 119,09	2 466,04	2 770,15	3 114,62	3 418,73
2000	1 817,47	1 983,37	2 357,89	2 689,69	3 064,32	3 398,62	3 730,42

## Przepustnica samoczynna ścienna • Automatic wall damper

**PSS**



**Materiał** • *Material:*

- profil, żaluzja - aluminium • *shape, louver - aluminium*
- prowadnice żaluzji - tworzywo sztuczne • *louver drives - plastic*

**Wykonanie z aluminium zapobiega powstawaniu korozji.**

• *Aluminium prevents the occurrence of corrosion.*

H [mm]	Cena [PLN/szt.] • Price [PLN/pc]						
	B [mm]						
	300	400	600	800	1000	1200	1400
300	445,26	491,98	582,61	673,13	763,76	854,39	989,04
400	525,61	577,42	683,51	789,71	895,81	999,42	1 149,63
600	683,51	750,89	885,53	1 020,18	1 157,42	1 291,96	1 470,62
800	882,94	965,78	1 131,47	1 294,56	1 460,35	1 626,04	1 877,16
1000	1 040,84	1 139,25	1 333,39	1 527,62	1 765,87	1 915,99	2 195,66
1200	1 198,73	1 310,13	1 535,41	1 758,09	2 024,68	2 206,04	2 516,65
1400	1 356,75	1 483,60	1 778,75	2 032,47	2 286,29	2 540,01	2 881,76
1600	1 556,06	1 698,50	1 980,77	2 265,53	2 591,82	2 873,98	3 200,27
1800	1 714,07	1 871,97	2 182,68	2 540,01	2 853,33	3 207,95	3 521,26
2000	1 871,97	2 042,85	2 428,62	2 770,37	3 156,25	3 500,60	3 842,35

Możliwość wykonania przepustnicy o wymiarach w zakresie H=200÷2000 mm oraz B=200÷1400 mm - cena na zapytanie.

• *Possible manufacturing within range H=200÷2000 mm and B=200÷1400 mm - price on inquiry.*



## Czerpnia/wyrzutnia prostokątna stalowa ocynkowana

• Galvanized steel rectangular air intake/exhauster

CW



Stal ocynkowana, system profili stalowych • galvanized steel, steel shapes system.

Minimalna wysokość czerpni • min. height of the air intake: H = 200 mm.

Maks. wielkość czerpni • max. size of the air intake: B × H = 3000 mm × 2000 mm.

H [mm]	Cena [PLN/szt.] • Price [PLN/pc]									
	B [mm]									
	300	400	600	800	1000	1200	1400	1600	1800	2000
300	198,07	213,52	236,69	272,74	320,74	394,18	536,53	602,24	653,33	700,71
400	252,14	288,19	306,12	349,89	409,73	493,37	675,17	733,57	784,65	846,76
600	285,62	329,39	373,07	411,59	482,45	578,14	784,65	857,68	923,40	981,80
800	352,47	398,71	447,64	506,86	579,48	694,84	945,23	1 029,18	1 105,81	1 182,44
1000	447,43	504,08	560,53	636,03	687,32	826,27	1 113,22	1 200,67	1 277,41	1 372,27
1200	525,51	579,48	644,16	730,37	800,41	945,95	1 277,41	1 372,27	1 463,53	1 558,39
1400	824,82	908,77	1 010,95	1 131,46	1 240,94	1 350,43	1 456,21	1 562,10	1 667,88	1 773,76
1600	941,63	1 036,49	1 138,77	1 277,41	1 390,50	1 507,30	1 583,93	1 744,61	1 865,02	1 978,12
1800	1 069,35	1 175,23	1 284,72	1 474,45	1 562,10	1 689,82	1 824,85	1 945,26	2 080,29	2 215,32
2000	1 207,98	1 313,87	1 452,61	1 591,25	1 642,34	1 865,02	2 010,97	2 142,40	2 288,35	2 430,70

## Czerpnia/wyrzutnia prostokątna aluminiowa

• Aluminium rectangular air intake/exhauster

CWA

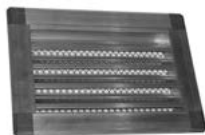

Aluminium, system profili aluminiowych • aluminium, aluminium shapes system.

Minimalna wysokość czerpni • min. height of the air intake: H = 200 mm.

Maks. wielkość czerpni • max. size of the air intake: B × H = 3000 mm × 2000 mm.

H [mm]	Cena [PLN/szt.] • Price [PLN/pc]									
	B [mm]									
	300	400	600	800	1000	1200	1400	1600	1800	2000
300	368,79	397,56	440,60	507,77	569,95	646,63	704,06	790,36	857,41	919,71
400	469,37	536,42	569,95	651,39	728,07	809,51	886,18	962,75	1 029,80	1 111,25
600	531,67	613,11	694,54	766,35	857,41	948,37	1 029,80	1 125,63	1 211,83	1 288,50
800	656,25	742,45	833,40	943,61	1 029,80	1 140,01	1 240,59	1 350,79	1 451,37	1 551,95
1000	795,12	895,70	996,28	1 130,38	1 221,45	1 355,55	1 460,89	1 575,86	1 676,44	1 801,03
1200	933,98	1 029,80	1 144,77	1 298,02	1 422,61	1 551,95	1 676,44	1 801,03	1 920,74	2 045,33
1400	1 082,48	1 192,68	1 326,78	1 484,90	1 628,52	1 772,26	1 911,23	2 050,09	2 188,96	2 327,93
1600	1 235,84	1 360,31	1 494,42	1 676,44	1 824,92	1 978,18	2 078,86	2 289,54	2 447,65	2 596,15
1800	1 403,47	1 542,33	1 686,06	1 935,13	2 050,09	2 217,72	2 394,87	2 552,99	2 730,25	2 907,50
2000	1 585,38	1 724,34	1 906,37	2 088,38	2 155,43	2 447,65	2 639,19	2 811,68	3 003,22	3 190,11

Możliwość wykonania czerpni o wymiarach w zakresie H=200+2000 mm oraz B=200+3000 mm - cena na zapytanie.

• Possible manufacturing within range H=200+2000 mm and B=200+3000 mm - price on inquiry.



## Wyrzutnia/czerpnia prostokątna dachowa

• Roof rectangular air exhauster/intake

**WDP**

Typ • Type A



Typ • Type B

Wymiar • Dimensions A x B [mm]	Cena [PLN/szt.] • Price [PLN/pc]	
	Type A • Type A	Type B • Type B
<b>250×250</b>	236,90	453,20
<b>250×400</b>	319,30	515,00
<b>250×630</b>	283,25	545,90
<b>400×400</b>	422,30	597,40
<b>400×630</b>	669,50	1 297,80

Wymiar • Dimensions A x B [mm]	Cena [PLN/szt.] • Price [PLN/pc]	
	Type A • Type A	Type B • Type B
<b>630×630</b>	865,20	1 565,60
<b>630×1000</b>	1 236,00	2 080,60
<b>630×1600</b>	1 833,40	2 760,40
<b>1000×1000</b>	2 049,70	2 945,80
<b>1000×1600</b>	2 575,00	4 109,70

## Czerpnia dachowa okrągła • Round air intake

**CDO**



øD [mm]	Cena [PLN/szt.] • Price [PLN/pc]
<b>100</b>	190,55
<b>125</b>	190,55
<b>160</b>	231,75
<b>200</b>	262,65
<b>250</b>	329,60

øD [mm]	Cena [PLN/szt.] • Price [PLN/pc]
<b>315</b>	432,60
<b>400</b>	679,80
<b>500</b>	875,50
<b>630</b>	1 256,60

## Wyrzutnia dachowa okrągła • Round air exhauster

**WDO-C**



øD [mm]	Cena [PLN/szt.] • Price [PLN/pc]
<b>100</b>	144,20
<b>125</b>	144,20
<b>160</b>	185,40
<b>200</b>	185,40
<b>250</b>	236,90

øD [mm]	Cena [PLN/szt.] • Price [PLN/pc]
<b>315</b>	339,90
<b>400</b>	515,00
<b>500</b>	700,40
<b>630</b>	1 122,70

## Wyrzutnia z kołnierzem VKPK • Air exhauster with VKPK flange

**HF**



øD [mm]	Cena [PLN/szt.] • Price [PLN/pc]
<b>100</b>	257,50
<b>125</b>	267,80
<b>160</b>	288,40
<b>200</b>	339,90
<b>250</b>	463,50

øD [mm]	Cena [PLN/szt.] • Price [PLN/pc]
<b>315</b>	710,70
<b>400</b>	1 009,40
<b>500</b>	1 236,00
<b>630</b>	1 761,30
<b>800</b>	2 575,00



### Wyrzutnia z odejściem na rurę • Air exhauster to fit round duct

HN



øD [mm]	Cena [PLN/szt.] • Price [PLN/pc]
100	257,50
125	267,80
160	288,40
200	339,90
250	463,50

øD [mm]	Cena [PLN/szt.] • Price [PLN/pc]
315	710,70
400	1 009,40
500	1 236,00
630	1 761,30
800	2 575,00

### Czerpnia dachowa • Roof air intake

K



ød [mm]	øD [mm]	Cena [PLN/szt.] • Price [PLN/pc]
100	200	185,40
125	225	185,40
150	250	216,30
160	260	216,30
180	285	226,60
200	315	226,60

ød [mm]	øD [mm]	Cena [PLN/szt.] • Price [PLN/pc]
250	400	309,00
315	500	370,80
355	550	453,20
400	600	494,40
450	650	576,80
500	700	659,20

### Ośłona dachowa • Ventilation cap

KV



≤ ø200



> ø200

ød [mm]	Cena [PLN/szt.] • Price [PLN/pc]
100	45,94
125	57,89
150	60,56
160	62,32
180	67,88
200	75,71
250	98,47

ød [mm]	Cena [PLN/szt.] • Price [PLN/pc]
315	152,44
355	184,89
400	216,92
450	255,96
500	321,88
630	419,52

### Wywietrzak cylindryczny • Round gravity ventilator

WDC



øD [mm]	Cena [PLN/szt.] • Price [PLN/pc]
100	190,55
125	190,55
160	206,00
200	298,70
250	350,20

øD [mm]	Cena [PLN/szt.] • Price [PLN/pc]
315	504,70
400	669,50
500	1 112,40
630	1 359,60



## Czerpnia/wyrzutnia okrągła, stal chromo-niklowa

• Round air intakes/exhausters, chrome-nickel plated

VLA



Typ - Type	øA [mm]	øB [mm]	C [mm]	Cena [PLN/szt.] • Price [PLN/pc]
<b>VLA-100</b>	97	133	52	127,51
<b>VLA-125</b>	120	165	52	169,54
<b>VLA-150</b>	145	192	62	203,12
<b>VLA-160</b>	155	192	62	210,43
<b>VLA-200</b>	195	253	62	387,38

## Czerpnia/wyrzutnia okrągła, aluminium

• Round air intakes/exhausters, aluminium

KWO-AL



Typ - Type	ød [mm]	øD [mm]	H [mm]	Cena [PLN/szt.] • Price [PLN/pc]
<b>KWO-AL 100</b>	100	125	20	47,07
<b>KWO-AL 125</b>	125	150	20	53,56
<b>KWO-AL 160</b>	160	185	20	64,27
<b>KWO-AL 200</b>	200	225	20	70,66
<b>KWO-AL 250</b>	250	275	20	171,19
<b>KWO-AL 315</b>	315	350	20	224,75
<b>KWO-AL 400</b>	400	435	35	425,80

## Czerpnia/wyrzutnia ścienna aluminiowa

• Round air intakes/exhausters, aluminium

ELB



øD [mm]	Cena [PLN/szt.] • Price [PLN/pc]
<b>100</b>	66,33
<b>125</b>	74,26
<b>150</b>	90,43
<b>160</b>	96,82
<b>200</b>	150,38
<b>250</b>	229,28
<b>315</b>	318,79



## Drzwi rewizyjne - Access doors

RD

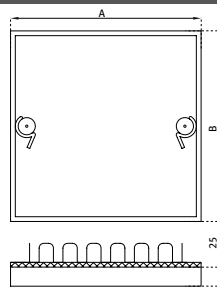

Drzwi rewizyjne na kanał prostokątny, wykonane z blachy stalowej ocynkowanej. W skład zestawu wchodzi izolowane drzwi o grubości 25 mm wraz z zamkami i ramka przystosowana do montażu na kanale. Ramka dostarczana jest z uszczelkami.

*Access door for a rectangular duct. Made of galvanized steel. The set includes insulated doors with a thickness of 25 mm with locks and frame suitable for mounting in the duct. The frame is insulated with gasket.*

Typ · Type	Wymiar A × B · Nominal size [mm]	Wymiar otworu montażowego · Duct opening size [mm]	Cena [PLN/szt.] · Price [PLN/pc]
<b>RD 15</b>	150 × 150	120 × 120	64,79
<b>RD 20</b>	200 × 200	170 × 170	73,44
<b>RD 21</b>	200 × 125	170 × 95	73,95
<b>RD 25</b>	250 × 250	220 × 220	92,80
<b>RD 30</b>	300 × 300	270 × 270	109,70
<b>RD 31</b>	300 × 150	270 × 120	83,12
<b>RD 32</b>	300 × 200	270 × 170	92,08
<b>RD 35</b>	350 × 350	320 × 320	133,18
<b>RD 40</b>	400 × 400	370 × 370	153,47
<b>RD 42</b>	400 × 200	370 × 170	117,01
<b>RD 425</b>	400 × 250	370 × 220	121,85
<b>RD 43</b>	450 × 300	420 × 270	145,64
<b>RD 44</b>	400 × 300	370 × 270	136,78
<b>RD 45</b>	450 × 450	420 × 420	202,50
<b>RD 50</b>	500 × 500	470 × 470	232,88
<b>RD 63</b>	600 × 300	570 × 270	193,95
<b>RD 64</b>	600 × 400	570 × 370	229,18
<b>RD 65</b>	600 × 450	570 × 420	248,75
<b>RD 66</b>	600 × 600	570 × 570	298,80





## Klapa rewizyjna na kanał okrągły • Curved access door for round duct

**KR**



A × B [mm]	Średnica rury • Pipe diameter [mm]	Cena [PLN/szt.] • Price [PLN/pc]
<b>180 × 80</b>	Ø100 ÷ Ø125	50,06
<b>250 × 150</b>	Ø160 ÷ Ø400	82,61
<b>400 × 300</b>	Ø400 ÷ Ø800	167,38

## Klapa rewizyjna na kanał prostokątny • Flat access door for rectangular duct

**FAD**



A × B [mm]	Cena [PLN/szt.] • Price [PLN/pc]
<b>180 × 180</b>	29,36
<b>200 × 100</b>	43,88
<b>250 × 150</b>	62,93
<b>300 × 200</b>	131,94
<b>400 × 300</b>	234,53
<b>500 × 400</b>	420,34
<b>600 × 450</b>	505,32

## Nasada kominowa (nierdzewna) • Chimney root (stainless steel)

**ROTOFLEX**



øD [mm]	nyplowa dzielona • split with coupling		z kołnierzem • with flange		z podstawą • with base	
	„pletwa”	„kogut”	„pletwa”	„kogut”	„pletwa”	„kogut”
	Cena [PLN/szt.] • Price [PLN/pc]					
<b>130</b>	367,10	367,10	367,10	367,10	367,10	367,10
<b>150</b>	393,90	393,90	393,90	393,90	393,90	393,90
<b>180</b>	426,40	426,40	426,40	426,40	426,40	426,40
<b>200</b>	448,50	448,50	448,50	448,50	448,50	448,50
<b>250</b>	481,60	481,60	481,60	481,60	481,60	481,60
<b>300</b>	555,10	555,10	555,10	555,10	555,10	555,10
<b>350</b>	701,30	701,30	701,30	701,30	701,30	701,30



## Nasada kominowa • Chimney root

## CENTROWENT



øD [mm]	nyplowa • coupling		nyplowa dzielona • split with coupling		z kołnierzem • with flange		z podstawą • with base	
	CA <sup>1)</sup>	CN <sup>1)</sup>	CA <sup>1)</sup>	CN <sup>1)</sup>	CA <sup>1)</sup>	CN <sup>1)</sup>	CA <sup>1)</sup>	CN <sup>1)</sup>
	Cena [PLN/szt.] • Price [PLN/pc]							
<b>130</b>	231,40	323,10	284,00	351,20	315,50	384,00	314,40	409,50
<b>150</b>	239,30	340,00	293,50	369,40	330,00	413,80	322,50	431,80
<b>160</b>	241,10	363,50	321,60	403,90	338,50	424,40	326,10	439,00
<b>200</b>	278,90	435,30	355,20	445,60	358,20	487,10	346,10	518,50
<b>250</b>	386,60	587,50	482,80	556,60	454,40	655,10	441,90	656,00
<b>300</b>	529,10	619,90	553,00	706,80	543,60	750,10	479,50	796,80
<b>315</b>	431,70	672,60	578,80	×	560,60	×	527,60	×
<b>400</b>	721,50	×	779,30	×	763,20	×	740,90	×
<b>450</b>	802,00	×	871,90	×	849,50	×	820,80	×
<b>500</b>	842,20	×	909,70	×	962,00	×	926,30	×

<sup>1)</sup> CA - Aluminium CN - Stal nierdzewna • Stainless steel

## Kominek • Ventilation caps

## VH



ød [mm]	Cena [PLN/szt.] • Price [PLN/pc]
<b>100</b>	72,10
<b>125</b>	76,22
<b>140</b>	79,31
<b>150</b>	86,52
<b>160</b>	89,61
<b>180</b>	98,88
<b>200</b>	112,27
<b>225</b>	118,45
<b>250</b>	123,60
<b>280</b>	144,20
<b>300</b>	185,40

ød [mm]	Cena [PLN/szt.] • Price [PLN/pc]
<b>315</b>	185,40
<b>355</b>	236,90
<b>400</b>	288,40
<b>450</b>	360,50
<b>500</b>	515,00
<b>560</b>	690,10
<b>600</b>	947,60
<b>630</b>	1 019,70
<b>710</b>	1 287,50
<b>800</b>	1 751,00



## Podstawa dachowa • Roof base

PD-B

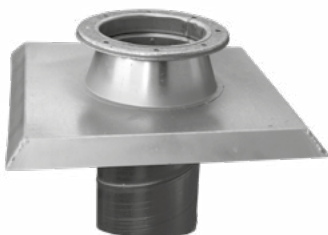

øD [mm]	Cena [PLN/szt.] • Price [PLN/pc]		
	B I	B II	B III
<b>100</b>	164,80	195,70	309,00
<b>125</b>	164,80	195,70	309,00
<b>160</b>	195,70	231,75	350,20
<b>200</b>	206,00	278,10	412,00
<b>250</b>	226,60	314,15	484,10
<b>315</b>	247,20	334,75	618,00
<b>400</b>	298,70	473,80	813,70
<b>500</b>	463,50	721,00	1 081,50
<b>630</b>	607,70	947,60	1 431,70
<b>800</b>	875,50	1 236,00	1 936,40

## Podstawa dachowa prostokątna • Rectangular roof base

PD-P



Wymiar • Size A x B [mm]	Cena [PLN/szt.] • Price [PLN/pc]
<b>250 × 250</b>	391,40
<b>250 × 400</b>	463,50
<b>250 × 630</b>	556,20
<b>400 × 400</b>	700,40
<b>400 × 630</b>	813,70
<b>630 × 630</b>	1 009,40
<b>630 × 1000</b>	1 339,00
<b>630 × 1600</b>	1 761,30
<b>1000 × 1000</b>	1 874,60

**Podstawa dachowa prostokątna • Rectangular roof base**
**PD-S**

Produkt przystosowany do montażu następujących typów wentylatorów:

Systemair: DVS, DHS, DVSI, DVN, DVNI, DVC;

Rosenberg: DV, DH, DVS, DVWN, DVWNS, DV-G.

Wykonanie z blachy ocynkowanej zapewnia odporność na korozję.

*The bases are adapted to assembly of the following ventilators:*

*Systemair: DVS, DHS, DVSI, DVN, DVNI, DVC;*

*Rosenberg: DV, DH, DVS, DVWN, DVWNS, DV-G.*

*It is made of the zinc coated sheet that makes anticorrosive protection.*



Typ • Type	Cena [PLN/szt.] • Price [PLN/pc]
<b>PD-S 190/225</b>	576,80
<b>PD-S 310/311</b>	648,90
<b>PD-S 355/400</b>	772,50
<b>PD-S 450/499/500</b>	824,00
<b>PD-S 560/630</b>	1 153,60
<b>PD-S 710</b>	1 411,10
<b>PD-S 800/900</b>	1 730,40

**Podstawa dachowa prostokątna tłumiąca • Rectangular muffler roof base**
**PD-ST**

Do zastosowań o podwyższonych wymaganiach odnośnie parametrów akustycznych.

Tłumienie dźwięku przy 250Hz wynosi średnio 8 dB.

Materiał pochłaniający dźwięk jest odporny na ścieranie do prędkości 20 m/s.

Przystosowany do montażu następujących typów wentylatorów:

Systemair: DVS, DHS, DVSI, DVN, DVNI, DVC;

Rosenberg: DV, DH, DVS, DVWN, DVWNS, DV-G.

*Attenuating roof base for roof ventilators is to be used in case of higher acoustic requirements.*

*Sound attenuation with frequency of 250 Hz is 8 dB on the average.*

*The sound attenuating material is resistant to wear up to 20 m/sec.*

*The bases are adapted to operate with the following ventilators:*

*Systemair: DVS, DHS, DVSI, DVN, DVNI, DVC;*

*Rosenberg: DV, DH, DVS, DVWN, DVWNS, DV-G*



Typ • Type	Cena [PLN/szt.] • Price [PLN/pc]
<b>PD-ST 190/225</b>	1 081,50
<b>PD-ST 310/311</b>	1 287,50
<b>PD-ST 355/400</b>	1 637,70
<b>PD-ST 450/499/500</b>	1 751,00
<b>PD-ST 560/630</b>	2 523,50
<b>PD-ST 710</b>	3 141,50
<b>PD-ST 800/900</b>	3 965,50



## Filtr kanałowy okrągły EU4 - Round duct filter EU4

**OFK**



øD [mm]	Cena [PLN/szt.] - Price [PLN/pc]
<b>100</b>	247,20
<b>125</b>	247,20
<b>160</b>	329,60
<b>200</b>	350,20
<b>250</b>	370,80
<b>315</b>	401,70
<b>355</b>	442,90
<b>400</b>	504,70

## Filtr kanałowy okrągły EU4 - Round duct filter EU4

**FKO**



øD [mm]	A [mm]	B [mm]	Cena [PLN/szt.] - Price [PLN/pc]
<b>100</b>	180	180	247,20
<b>125</b>	180	180	247,20
<b>160</b>	210	180	329,60
<b>200</b>	250	180	350,20
<b>250</b>	300	180	370,80
<b>315</b>	360	180	401,70
<b>355</b>	400	180	442,90
<b>400</b>	450	180	504,70

## Filtr kanałowy szufladowy EU4 - Cassette duct filter EU4

**FS**



B [mm]	<b>200</b>	<b>400</b>	<b>600</b>	<b>800</b>	<b>1000</b>	<b>1250</b>
H [mm]	Cena [PLN/szt.] - Price [PLN/pc]					
<b>200</b>	383,68	383,68	474,93	531,89	569,90	626,86
<b>400</b>	383,68	383,68	474,93	569,90	607,80	797,84
<b>600</b>	474,93	474,93	550,84	683,82	816,79	1 063,78
<b>800</b>	531,89	569,90	664,87	873,75	1 139,70	1 329,73
<b>1000</b>	569,90	607,80	778,78	1 120,74	1 158,75	1 614,63
<b>1250</b>	626,86	797,84	1 006,72	1 291,72	1 614,63	1 975,54

Możliwość wykonania filtrów kanałowych o indywidualnych wymiarach w zakresie H = 200 + 1250 mm oraz B = 200 + 1250 mm - cena na zapytanie ofertowe. • Possible manufacturing within range H = 200 + 1250 mm and B = 200 + 1250 mm - price on inquiry.



**Kratka typ AI z siatki stalowej ocynkowanej z ramką płaską**  
 • Grille made of galvanized steel mesh with the flat frame

**KSS**



Siatka stalowa ocynkowana, wielkość oczek 12 x 12 mm.  
 Cena obejmuje wyłącznie kratkę bez kanału przyłączeniowego.

*Pulled steel wire mesh, openings 12 x 12 mm.*

*Price comprises the grille only, without connecting duct.*

H [mm]	Cena [PLN/szt.] • Price [PLN/pc]									
	B [mm]									
	300	400	600	800	1000	1200	1400	1600	1800	2000
<b>300</b>	104,13	108,05	116,18	149,04	156,25	170,16	202,09	215,79	257,40	278,10
<b>400</b>	110,11	114,23	144,20	153,88	158,62	177,78	213,00	221,14	266,36	283,97
<b>600</b>	116,18	144,20	153,88	158,62	163,46	185,30	223,92	240,40	281,09	319,61
<b>800</b>	149,04	153,88	158,62	163,46	175,41	195,19	256,68	292,21	352,05	399,43
<b>1000</b>	156,25	158,62	163,46	175,41	189,93	237,83	305,91	355,14	449,80	485,23
<b>1200</b>	163,46	170,67	177,88	187,36	230,72	287,89	376,88	428,79	520,77	582,88
<b>1400</b>	194,05	201,88	215,06	246,48	293,55	379,56	434,25	502,54	609,55	680,52
<b>1600</b>	225,57	231,24	251,32	305,50	371,21	445,48	525,30	582,36	717,60	801,13
<b>1800</b>	269,14	281,50	296,85	368,12	464,02	544,46	637,26	714,51	801,13	893,94
<b>2000</b>	290,67	296,85	334,13	420,76	510,47	609,35	711,42	801,13	893,94	986,74

Możliwość wykonania o indywidualnych wymiarach w zakresie H=300+1500 mm oraz B=300+1500 mm - cena na zapytanie.

• Possible manufacturing within range H=300+1500 mm oraz B=300+1500 mm - price on inquiry.



### Króciec elastyczny okrągły bez kołnierzy

• Circular flexible connector pipe without flange

**KEO**



øD [mm]	Cena [PLN/szt.] • Price [PLN/pc]
<b>80</b>	24,72
<b>100</b>	26,78
<b>125</b>	28,84
<b>160</b>	30,90
<b>200</b>	33,99
<b>250</b>	37,08

øD [mm]	Cena [PLN/szt.] • Price [PLN/pc]
<b>315</b>	41,20
<b>400</b>	47,38
<b>500</b>	54,59
<b>630</b>	69,01
<b>800</b>	81,37
<b>1000</b>	101,97

### Króciec elastyczny okrągły z kołnierzami

• Circular flexible connector pipe with flange

**KEO-K**



øD [mm]	Cena [PLN/szt.] • Price [PLN/pc]
<b>80</b>	71,07
<b>100</b>	77,25
<b>125</b>	82,40
<b>160</b>	88,58
<b>200</b>	100,94
<b>250</b>	123,60

øD [mm]	Cena [PLN/szt.] • Price [PLN/pc]
<b>315</b>	145,23
<b>400</b>	178,19
<b>500</b>	236,90
<b>630</b>	391,40
<b>800</b>	444,96
<b>1000</b>	611,82

### Króciec elastyczny prostokątny • Rectangular flexible duct connector

**KEP**



B [mm]	<b>200</b>	<b>400</b>	<b>600</b>	<b>800</b>	<b>1000</b>	<b>1250</b>
A [mm]	Cena [PLN/szt.] • Price [PLN/pc]					
<b>200</b>	78,90	107,74	135,14	167,68	200,34	245,24
<b>400</b>	107,74	141,93	167,68	200,34	230,10	280,37
<b>600</b>	141,93	176,03	200,34	230,10	262,75	315,39
<b>800</b>	167,68	200,34	230,10	272,85	305,29	347,83
<b>1000</b>	200,34	230,10	262,75	305,29	340,31	390,37
<b>1250</b>	245,24	270,27	315,39	347,83	390,37	437,96



**Tłumik akustyczny okrągły prosty • Circular silencer**

**SLL**



W styczniu 2010 jakość tłumików okrągłych SLL potwierdziliśmy badaniami zgodnie z ISO 7235 testującego właściwości tłumiące oraz poziom strat ciśnienia w niemieckich laboratoriach firmy Muller-BBM GmbH, których wyniki okazały się ponadprzeciętnie dobre. Wszystkie szczegółowe informacje dotyczące cechy testu oraz parametrów technicznych znajdują się na naszej stronie [www.centrumklima.pl](http://www.centrumklima.pl).

*In January 2010 we've tested whole range of round silencers SLL in accordance with ISO 7235 standard for attenuation and pressure loss in German laboratories of Muller-BBM GmbH, which proved to be more than satisfactory. All details can be found on our webpage: [www.centrumklima.pl](http://www.centrumklima.pl).*

Izolacja 50 mm • Insulation 50 mm

ØD <sub>1</sub> [mm]	100	125	160	200	250	315	355	400	450	500	560	630
L [mm]	Cena [PLN/szt.] • Price [PLN/pc]											
<b>300</b>	185,09	198,89	228,76	267,18	346,60	358,54	424,05	622,33	684,44	821,73	953,37	1 105,50
<b>600</b>	223,00	247,51	290,15	341,14	446,51	478,54	557,64	809,17	877,35	1 032,27	1 186,87	1 365,16
<b>900</b>	272,64	308,59	365,86	431,98	568,15	621,09	787,85	966,04	1 112,71	1 294,20	1 479,80	1 693,73
<b>1000</b>	289,12	328,98	391,09	462,16	608,73	668,57	846,45	1 036,18	1 191,30	1 381,54	1 577,34	1 803,32
<b>1200</b>	321,46	368,23	439,91	520,87	687,22	759,42	959,55	1 168,33	1 337,56	1 543,15	1 756,05	2 005,20

Izolacja 100 mm • Insulation 100 mm

ØD <sub>1</sub> [mm]	100	125	160	200	250	315	355	400	450	500	560	630
L [mm]	Cena [PLN/szt.] • Price [PLN/pc]											
<b>300</b>	244,83	252,04	290,67	345,98	445,37	481,53	561,35	800,72	888,79	990,55	1 161,84	1 371,45
<b>600</b>	313,53	328,06	383,57	462,37	597,40	659,72	757,26	1 052,56	1 146,60	1 261,44	1 459,20	1 703,41
<b>900</b>	397,27	419,93	494,61	600,39	777,14	868,08	1 085,41	1 264,12	1 460,13	1 594,54	1 828,87	2 121,08
<b>1000</b>	425,29	450,52	531,58	646,22	837,18	937,40	1 170,08	1 358,16	1 564,57	1 705,58	1 951,95	2 260,34
<b>1200</b>	479,47	510,47	603,79	734,70	952,54	1 068,11	1 330,35	1 534,19	1 757,70	1 912,50	2 178,66	2 515,88





## Tłumik elastyczny okrągły • Circular flexible silencers

## SLL S-FLEX



Obudowa zewnętrzna wykonana jest z przewodu półelastycznego aluminiowego S-Flex®.  
Warstwę tłumiącą stanowi wełna mineralna, zabezpieczona od strony instalacji przewodem z perforacją.

*External cover made of semi-flexible aluminum duct S-Flex®.  
Damping layer of mineral wool secured with perforated aluminum duct.*

Izolacja 50 mm • Insulation 50 mm

øD [mm]	80	100	125	150	160	200	250	315
L [mm]	Cena [PLN/szt.] • Price [PLN/pc]							
<b>600</b>	194,26	196,42	213,31	232,16	232,16	295,61	331,45	375,85
<b>900</b>	232,16	240,61	268,11	291,39	293,55	363,18	415,91	470,81
<b>1000</b>	236,39	246,99	274,50	299,83	304,06	373,68	428,58	542,60
<b>1200</b>	268,11	282,94	314,46	344,12	346,18	424,36	483,48	629,12
<b>1500</b>	289,22	312,40	348,35	384,29	386,35	475,04	551,05	686,08

## Łącznik półelastyczny • Semiflexible connector

## DRATMF



øD [mm]	80	100	125	160	200	250	315
L [mm]	Cena [PLN/szt.] • Price [PLN/pc]						
<b>500</b>	52,12	53,46	59,33	73,65	87,14	108,77	140,80
<b>1000</b>	59,12	61,39	70,45	89,10	106,81	137,09	205,69
<b>1500</b>	67,88	73,34	83,43	104,55	131,33	166,96	227,42



## Tłumik akustyczny płytowy • Rectangular silencer

TAP



Ilość działek • Number of slits	1	2	3	4	5	6	7	8
B [mm]	150-200	300-400	450-600	750-800	900-1000	1050-1200	1350-1400	1500-1600
H [mm]	Cena [PLN/szt.] • Price [PLN/pc]							
Długość tłumika: • Length: L = 600 mm								
300	306,63	519,12	731,61	980,35	1 212,21	×	×	×
450	335,68	565,06	801,65	1 043,18	1 286,99	1 535,73	1 798,90	1 912,40
600	371,83	610,89	864,48	1 108,38	1 354,66	1 642,03	1 910,03	2 185,25
900	434,66	707,51	997,25	1 238,78	1 514,00	1 798,90	2 086,27	2 388,16
Długość tłumika: • Length: L = 1000 mm								
300	407,78	690,20	997,76	1 127,64	1 608,24	×	×	×
450	457,94	769,93	1 097,98	1 460,23	1 760,89	2 054,75	2 346,34	2 631,03
600	514,79	847,38	1 186,87	1 587,75	1 904,47	2 227,89	2 555,95	2 895,33
900	624,18	1 018,26	1 423,77	1 829,28	2 216,46	2 608,27	3 025,21	3 423,82
Długość tłumika: • Length: L = 1200 mm								
300	464,74	749,43	1 041,02	1 401,01	1 672,10	×	×	×
450	535,29	845,12	1 173,17	1 523,99	1 831,55	2 136,74	2 462,52	2 811,08
600	605,95	934,00	1 277,92	1 646,97	1 977,29	2 316,68	2 683,46	3 052,51
900	728,93	1 102,51	1 514,82	1 883,87	2 273,42	2 669,86	3 086,70	3 510,34
Długość tłumika: • Length: L = 1500 mm								
300	523,96	840,58	1 186,87	1 544,49	1 858,84	×	×	×
450	601,42	945,33	1 305,32	1 706,20	2 038,78	2 389,60	2 751,85	3 127,70
600	678,77	1 054,72	1 457,97	1 863,37	2 232,42	2 615,17	3 020,58	3 412,49
900	826,88	1 259,69	1 719,89	2 182,26	2 619,70	3 070,74	3 526,31	3 988,78

Możliwość wykonania o indywidualnych wymiarach w zakresie H=300+1500 mm oraz B=300+1500 mm - cena na zapytanie.

• Possible manufacturing within range H=300+1500 mm oraz B=300+1500 mm - price on inquiry.



Obejma do rur zwijanych bez uszczelki • Pipe clip for round ducts without gasket

OPO



øD [mm]	Op. <sup>*)</sup>	Cena [PLN/szt.] • Price [PLN/pc]
80	60	13,70
100	100	14,52
125	100	15,45
150	100	15,76
160	60	16,07
180	30	17,41
200	50	18,44
224	30	20,29
250	50	21,84

øD [mm]	Op. <sup>*)</sup>	Cena [PLN/szt.] • Price [PLN/pc]
315	50	25,75
355	50	28,94
400	50	32,24
500	10	46,35
560	10	63,45
630	10	63,04
710	10	66,23
800	10	78,18

Obejma do rur zwijanych z uszczelką • Pipe clip for round ducts with gasket

OPOX



øD [mm]	Op. <sup>*)</sup>	Cena [PLN/szt.] • Price [PLN/pc]
80	60	17,41
100	100	18,03
125	100	19,98
150	100	22,15
160	60	22,45
180	60	24,10
200	50	26,06
225	30	28,94
250	50	32,24

øD [mm]	Op. <sup>*)</sup>	Cena [PLN/szt.] • Price [PLN/pc]
315	50	38,63
355	50	41,82
400	50	45,11
500	10	76,22
560	10	84,87
630	10	102,90
710	10	105,27
800	10	114,33

Obejma kwasoodporna do rur zwijanych z uszczelką EPDM

• Pipe clips for round ducts with EPDM gasket (stainless steel)

OPOX INOX



øD [mm]	Op. <sup>*)</sup>	Cena [PLN/szt.] • Price [PLN/pc]
100	150	78,28
125	80	87,34
150	60	95,07
160	60	98,88
180	60	104,03
200	40	112,99
225	40	121,95

øD [mm]	Op. <sup>*)</sup>	Cena [PLN/szt.] • Price [PLN/pc]
250	35	127,21
315	40	152,85
355	15	164,39
400	25	179,84
500	5	363,90
630	5	449,60

<sup>\*)</sup> Ilość [szt./opak.] • Quantity [pcs/pack.]



Opaski zaciskowe, taśma do opasek, opaski montażowe

• Band clip, clip tape, supressing bands

## Zamek zaciskowy CMC

• Traction device

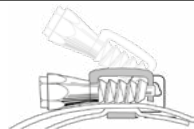

Opakowanie • Package [szt. • pcs]	Cena [PLN/opak.] • Price [PLN/pack.]
50	187,77

## Taśma do opasek CMB

• Tape in coil for band clip



Opakowanie • Package [mb]	Cena [PLN/opak.] • Price [PLN/pack.]
30	170,67

## Opaska zaciskowa metalowa CM

• Metal band clip



Zakresy średnic • Diameters range øD [mm]	Opak. • Package [szt. • pcs]	Cena [PLN/szt.] • Price [PLN/pc]
60-110	50	6,90
60-135	50	7,83
60-165	50	8,45
60-215	50	9,99
60-270	50	12,67
60-325	50	12,67
60-525	50	16,07
60-660	50	17,61

## Opaska zaciskowa nylonowa CMN

• Nylon band clip



Długość • Length L [mm]	Opak. • Package [szt. • pcs]	Cena [PLN/szt.] • Price [PLN/pc]
1188	100	5,46
920	100	3,91
800	100	3,40
650	100	2,68
550	100	2,47

## Opaska montażowa • Supressing band OM

Opaska montażowa przeciwdrganiowa do podwieszania wentylatorów kanałowych okrągłych.

Supressing bands for fan installation in round ducts.



Typ • Type	Średnica • Diameter [mm]	Cena [PLN/szt.] • Price [PLN/pc]
OM 100	100	33,78
OM 125	125	35,23
OM 150	150	36,77
OM 160	160	38,32
OM 200	200	41,41
OM 250	250	44,50
OM 315	315	47,48
OM 355	355	58,20
OM 400	400	64,38
OM 500	500	76,53



## Zawiesie ocynkowane L z amortyzatorem

• L type suspension



Opakowanie: 100 szt. • Package: 100 pcs

Zamówienia [szt.] • Order [pcs]	Cena [PLN/szt.] • Price [PLN/pc]
< 100	5,97
100 ÷ 2000	2,58
> 2000	1,34

## Zawiesie ocynkowane R/V z amortyzatorem

• R/V type suspension



Opakowanie: 100 szt. • Package: 100 pcs

Zamówienia [szt.] • Order [pcs]	Cena [PLN/szt.] • Price [PLN/pc]
< 100	5,97
100 ÷ 2000	2,58
> 2000	1,34

## Zawiesie ocynkowane Z z amortyzatorem

• Z type suspension



Opakowanie: 100 szt. • Package: 100 pcs

Zamówienia [szt.] • Order [pcs]	Cena [PLN/szt.] • Price [PLN/pc]
< 100	5,97
100 ÷ 2000	2,58
> 2000	1,34

## Zawiesia ze stali kwasoodpornej L/V/Z z amortyzatorem

• L/V/Z type suspensions (stainless steel)



Opakowanie: 100 szt. • Package: 100 pcs

Typ • Type	Cena [PLN/szt.] • Price [PLN/pc]
L	23,18
V	37,49
Z	23,18

## Nakrętka łączna

• Connecting nut

LN



Gwint • Thread	Op. *)	Cena [PLN/szt.] • Price [PLN/pc]
M8	100	1,75
M10	50	2,68



## Pręt gwintowany ocynkowany

• Threaded rod (galvanized steel)



Gwint • Thread	Op. <sup>1)</sup>	Cena [PLN/szt.] • Price [PLN/pc]	
		1+300 szt. • pcs	>300 szt. • pcs
L = 1000 m			
<b>M6</b>	25	3,91	1,65
<b>M8</b>	25	6,08	2,37
<b>M10</b>	25	7,73	3,71
L = 2000 m			
<b>M6</b>	50	7,73	3,09
<b>M8</b>	25	12,26	4,43
<b>M10</b>	25	15,24	7,00

## Pręt gwintowany ze stali kwasoodpornej

• Threaded rod (stainless steel)

Gwint • Thread	Op. <sup>1)</sup>	Cena [PLN/szt.] • Price [PLN/pc]
<b>M8</b>	25	108,15
<b>M10</b>	25	169,95

## Uchwyt pręta gwintowanego ocynkowany

• Beam clamp (galvanized steel)



Gwint • Thread	Op. <sup>1)</sup>	Cena [PLN/szt.] • Price [PLN/pc]	
		1+1000 szt. • pcs	>1000 szt. • pcs
<b>M6</b>	100	11,64	2,47
<b>M8</b>	100	11,64	2,47
<b>M10</b>	100	11,64	3,30

## Wieszaki Gripple • Gripple hangers



Typ • Type	Długość • Length [m]	Nośność • Load [kg]	Cena [PLN/szt.] • Price [PLN/pc]
<b>Wieszaki do kanałów okrągłych</b>			
<b>HF22SPEXP</b>	2	15 - 45	28,70
<b>HF22EF8EXP</b>	2		28,70
<b>HF24SPEXP</b>	4		35,30
<b>HF24EF8EXP</b>	4		35,30
<b>HF26SPEXP</b>	6		41,80
<b>Wieszaki do kanałów prostokątnych</b>			
<b>TPZP22SP</b>	2	15 - 45	34,10
<b>TPZP22EF8</b>	2		34,10
<b>TPZ25SP</b>	5		44,70
<b>TPZ25EF8</b>	5		44,70

<sup>1)</sup> Ilość [szt./opak.] • Quantity [pcs/pack.]

## MATERIAŁY MONTAŻOWE

Konsole kątowe, blachowkręty, tuleje kotwiące

• Consoles, self-drilling screws, anchor bushes



### Konsola kątowa typ T

• Console type T



Długość • Length [mm]	Profil • Profile	Cena [PLN/szt.] • Price [PLN/pc]
<b>420</b>	FT30	32,45
<b>510</b>	FT30	36,98
<b>690</b>	FT30	44,50

### Konsola kątowa typ T z odkosem

• Console type T with support



Długość • Length [mm]	Profil • Profile	Cena [PLN/szt.] • Price [PLN/pc]
<b>510</b>	FT30	73,23
<b>690</b>	FT30	88,07

### Blachowkręt ocynkowany

• Screw (galvanized steel)



Długość • Length [mm]	Op. <sup>1)</sup>	Cena [PLN/szt.] • Price [PLN/pc]		
		<5000 szt. • pcs	<20000 szt. • pcs	>20000 szt. • pcs
<b>4,2 × 9,50</b>	1000	137,40	75,60	54,90
<b>4,2 × 13,00</b>	1000	143,58	79,00	57,47
<b>4,2 × 25,00</b>	1000	198,48	109,08	79,41
samowierzące • self-drilling				
<b>4,2 × 9,50</b>	1000	148,32	81,58	59,23
<b>4,2 × 13,00</b>	1000	157,49	82,40	62,93
<b>4,2 × 16,00</b>	1000	165,32	93,63	72,82
<b>4,2 × 25,00</b>	1000	196,73	112,48	82,61
<b>4,2 × 42,00</b>	500	311,68	171,39	124,73
<b>4,8 × 16,00</b>	1000	204,66	123,70	88,58

### Tuleja kotwiąca • Anchor bush



Gwint • Thread	Op. <sup>1)</sup>	Cena [PLN/szt.] • Price [PLN/pc]	
		1+1000 szt. • pcs	>1000 szt. • pcs
STALOWA • GALVANIZED STEEL			
<b>M6</b>	100	1,34	0,41
<b>M8</b>	100	1,65	0,52
<b>M10</b>	100	1,85	0,93
MOSIĘŻNA • BRASS			
<b>M8</b>	100	3,40	1,75
<b>M10</b>	100	8,03	4,33

<sup>1)</sup> Ilość [szt./opak.] • Quantity [pcs/pack.]



### Zacisk kanału wentylacyjnego ocynkowany

• Ventilation duct clip (galvanized steel)



Opakowanie: 500 szt. • Package: 500 pcs  
100 szt. • pcs = 4,8 kg

Grubość • Thickness	Cena [PLN/szt.] • Price [PLN/pc]	
	1+5000 szt. • pcs	>5000 szt. • pcs
<b>2,5 mm</b>	2,58	0,52
<b>3,0 mm</b>	2,99	0,62

### Zacisk kanału wentylacyjnego ze stali kwasoodpornej

• Ventilation duct clip (stainless steel)



100 szt. • pcs = 4,8 kg

Cena [PLN/szt.] • Price [PLN/pc]
13,29

### Blachowkręt samowierzący ocynkowany

• Self-drilling screw (galvanized steel)

**DO WYCZERPANIA ZAPASÓW!**



Długość • Length [mm]	Op. <sup>1)</sup>	Cena [PLN/szt.] • Price [PLN/pc]		
		<5000 szt. • pcs	<20000 szt. • pcs	>20000 szt. • pcs
<b>4,2 × 16,00</b>	1000	163,98	93,01	72,20
<b>4,8 × 42,00</b>	1000	203,12	122,78	87,86
<b>4,2 × 16,00 „PAN HEAD”</b>	1000	163,98	93,01	72,20
<b>4,2 × 25,00 „PAN HEAD”</b>	1000	195,19	118,97	85,90
<b>4,2 × 42,00 „PAN HEAD”</b>	1000	273,26	171,08	117,11

### Podstawa profilu

• Profile base

FT



Cena [PLN/szt.] • Price [PLN/pc]
25,85

### Końcówka do blachowkrętów

• Terminal for screws



Typ • Type	Op. <sup>1)</sup>	Cena [PLN/opak.] • Price [PLN/pack.]
<b>7 mm</b>	1	19,26
<b>8 mm</b>	1	19,26
<b>„PAN HEAD”</b>	1	6,90

<sup>1)</sup> Ilość [szt./opak.] • Quantity [pcs/pack.]



## MATERIAŁY MONTAŻOWE



Silikon, uszczelki, śruby dwugwintowe, pianka montażowa

• Silicon, self-adhesive seals, double-threaded screws, assembly foam

### Silikon

• Silicon



Typ • Type	Pojemność • Capacity	Cena [PLN/szt.] • Price [PLN/pc]
<b>Szary akrylowy</b> • Acrylic	310 ml	17,30
<b>Ogniochronny</b> • Fire retardant	300 ml	93,73

### Pianka montażowa

• Assembly foam



Pojemność • Capacity	Cena [PLN/szt.] • Price [PLN/pc]
<b>700 ml</b>	47,59

**PE**

### Śruba dwugwintowa

• Double-threaded screw

**VDF**



Typ • Type	Opak. [szt.] • Package [pcs]	Cena [PLN/opak.] • Price [PLN/pack.]
<b>M8 × 100</b>	100	89,82
<b>M8 × 120</b>	100	104,13
<b>M8 × 150</b>	100	139,05
<b>M8 × 200</b>	100	205,49
<b>M10 × 80</b>	100	130,19
<b>M10 × 100</b>	100	150,59
<b>M10 × 120</b>	100	170,77

### Uszczelka wysokotemperaturowa

• Temperature resistant seal

**PEST**



Rozmiar • Size	Opakowanie [mb] • Package [m]	Cena [PLN/mb] • Price [PLN/m]
<b>10 × 4</b>	10	2,99
<b>10 × 5</b>	10	3,61
<b>10 × 6</b>	10	4,22

### Uszczelka

• Self-adhesive seal

**PES**



Rozmiar • Size	Opak. [mb] • Pack. [m]	Karton [mb] • Carton [m]	Cena [PLN/mb] • Price [PLN/m]
<b>15 × 4</b>	60	1200	0,93
<b>12 × 6</b>	50	1000	1,34
<b>10 × 4</b>	100	1000	0,82
<b>10 × 7</b>	50	900	1,24

## MATERIAŁY MONTAŻOWE



Śruby, nakrętki, taśmy perforowane, podkładki

• Screws, nuts, perforates suspension banding, washers

### Śruba ocynkowana

• Screw (galvanized steel)

BB



Typ • Type	Op <sup>1)</sup>	Waga • Weight [kg]	Cena [PLN/opak.] • Price [PLN/pack.]
<b>M8 × 25</b>	1000	12,5	493,68
<b>M8 × 50</b>	100	2,1	65,30
<b>M10 × 25</b>	1000	20,0	897,34

### Nakrętka ocynkowana

• Nut (galvanized steel)

NN



Gwint • Thread	Op <sup>1)</sup>	Waga • Weight [kg]	Cena [PLN/opak.] • Price [PLN/pack.]
<b>M6</b>	1000	2,0	80,65
<b>M8</b>	1000	4,5	161,50
<b>M10</b>	1000	10,0	354,01

### Nakrętka ze stali kwasoodpornej

• Nut (stainless steel)

NN

INOX



Gwint • Thread	Op <sup>1)</sup>	Waga • Weight [kg]	Cena [PLN/opak.] • Price [PLN/pack.]
<b>M8</b>	1000	4,5	1 103,34

### Taśma perforowana

• Perforated suspension banding

DUH



Typ • Type	Opakowanie [mb] • Package [m]	Cena [PLN/opak.] • Price [PLN/pack.]
<b>0,6 × 17</b>	25	91,46
<b>0,6 × 25</b>	25	136,17

### Podkładka ocynkowana

• Washer (galvanized steel)

WW



Gwint • Thread	Op <sup>1)</sup>	Waga • Weight [kg]	Cena [PLN/opak.] • Price [PLN/pack.]
<b>M6</b>	1000	5,0	205,07
<b>M8</b>	1000	5,5	222,58
<b>M10</b>	1000	6,0	231,44

<sup>1)</sup> Ilość [szt./opak.] • Quantity [pcs/pack.]

# MATERIAŁY MONTAŻOWE

Guma amortyzująca, gumki amortyzacyjne, kształtowniki montażowe

• Shock absorbing rubber, cushioning rubbers, support channels



## Guma amortyzująca

• Shock absorbing rubber

**RU-25**



Cena [PLN/m] • Price [PLN/m]

12,15

## Gumki amortyzacyjne

• Cushioning rubbers



Cena [PLN/szt.] • Price [PLN/pc]

1,24

## Kształtownik montażowy • Support channel

**W**

**W 18**

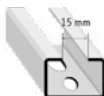

L [m]	Wymiary [mm] • Dimensions [mm]	Cena [PLN/szt.] • Price [PLN/pc]
2	18×27×1,25	41,61
5		104,13

**W 2**

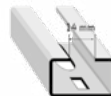

L [m]	Wymiary [mm] • Dimensions [mm]	Cena [PLN/szt.] • Price [PLN/pc]
2	20×34×2,0	50,99
5		127,31

**W 105**

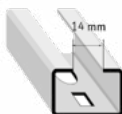

L [m]	Wymiary [mm] • Dimensions [mm]	Cena [PLN/szt.] • Price [PLN/pc]
2	20×30×1,5	46,25
5		115,77

**W 106**



L [m]	Wymiary [mm] • Dimensions [mm]	Cena [PLN/szt.] • Price [PLN/pc]
2	30×30×1,5	61,49
5		156,66
2	30×30×1,8	70,56
5		174,48

**W 107**



L [m]	Wymiary [mm] • Dimensions [mm]	Cena [PLN/szt.] • Price [PLN/pc]
2	43×30×1,5	90,02
5		224,95
2	43×30×1,8	100,12
5		244,93

**W 41**

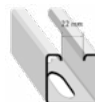

L [m]	Wymiary [mm] • Dimensions [mm]	Cena [PLN/szt.] • Price [PLN/pc]
5	41×41×1,8	306,73
5	41×41×2,5	404,58
6		485,34



### SolidFoot H Frame Kit

Uniwersalne stopy wspornikowe łączone kształtownikami 41×41 mm.

• Universal feet connected by support channel 41×41 mm.

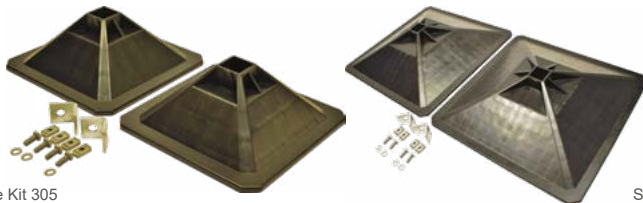

SolidFoot H Frame Kit 305

SolidFoot H Frame Kit 500

Typ • Type	Wymiar stopy • Feet [mm]	S.W.L. zestawu • Max S.W.L [kg]	Cena [PLN/opak.] • Price [PLN/pack.]
<b>SolidFoot H Frame Kit 305</b>	305×305	350	245,14
<b>SolidFoot H Frame Kit 500</b>	500×500	500	562,38

### SolidFoot Fix

Antywibracyjne podstawy do montażu małych urządzeń.

• Anti-vibration base for small units.



Typ • Type	Wymiary • Dimensions [mm]	Maks. udźwign na szt. • Max load / pc [kg]	Cena [PLN/szt.] • Price [PLN/pc]
<b>SolidFoot Fix 250*</b>	250×180×95	160	67,98
<b>SolidFoot Fix 400</b>	400×180×95	240	75,19
<b>SolidFoot Fix 600</b>	600×180×95	450	112,27
<b>SolidFoot Fix 1000*</b>	1000×180×95	645	238,96
<b>SolidFoot Fix 250L*</b>	250×130×50	160	62,83
<b>SolidFoot Fix 400L*</b>	400×130×50	240	76,22

\* Na zamówienie • On request



### SolidFoot Mini Base / Plus



SolidFoot Mini Base

Typ - Type	Wymiary - Dimensions [mm]	Maks. udźwig - Max load [kg]	Cena [PLN/kpl.] - Price [PLN/set]
<b>SolidFoot Mini Base</b>	800×800	300	1 091,80
<b>SolidFoot Mini Plus</b>	800×800	260	873,44

### SolidFoot Base / Plus

Modułowe ramy wspornikowe. - Modular frames.

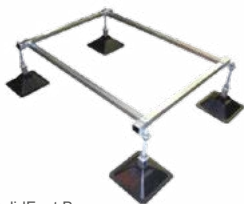

SolidFoot Base



SolidFoot Plus

Typ - Type	Wymiary - Dimensions [mm]	Maks. udźwig - Max load [kg]	Cena [PLN/kpl.] - Price [PLN/set]
<b>SolidFoot Base</b>	1000×1200	700	1 697,44
	1000×1500	700	2 188,75
<b>SolidFoot Plus</b>	1000×1200	350	990,86
	1000×1500	350	1 392,56

#### Przykładowa konfiguracja:

Modułowa konstrukcja umożliwiająca tworzenie własnej konfiguracji poprzez dołączanie kolejnych segmentów Plus do ramy podstawowej Base.

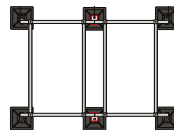

SolidFoot Base + SolidFoot Plus

\*) Na zamówienie - On request



### SolidFoot Beam\*

Kompletny zestaw wspornikowy z szeroką gamą zastosowań.

\* Complete support set.

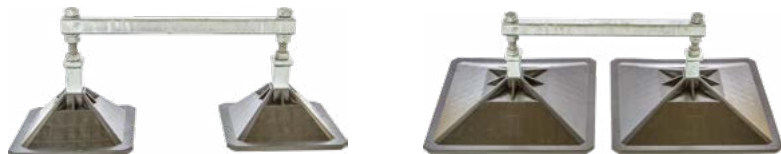

SolidFoot Beam 305

SolidFoot Beam 500

Typ - Type	Wymiar stopy - Feet [mm]	S.W.L. zestawu - Max S.W.L [kg]	Cena [PLN/kpl.] * Price [PLN/set]
<b>SolidFoot Beam 305</b>	305×305	350	832,24
<b>SolidFoot Beam 500</b>	500×500	500	951,72

### SolidFoot Platform\*

Modułowe platformy techniczne. \* Modular technical platform.



Typ - Type	Wymiary - Dimensions [mm]	Cena [PLN/szt.] * Price [PLN/pc]
<b>SolidFoot Platform</b>	1000×1000	3 116,78
<b>SolidFoot Platform - 1 Step</b>	1000×1000	12 138,55
<b>SolidFoot Platform - 2 Step</b>	1000×1000	14 115,12
<b>SolidFoot Platform - 3 Step</b>	1000×1000	15 905,26
<b>SolidFoot Platform - 4 Step</b>	1000×1000	17 607,85

\*) Na zamówienie - On request



### SolidFoot Mat\*

Podkładki antywibracyjne. • *Anti-vibration pads.*

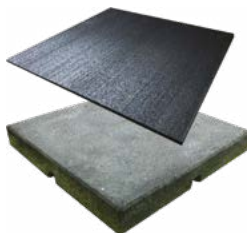

Typ • Type	Cena [PLN/szt.] • Price [PLN/pc]
<b>SolidFoot VibroMat 330H</b> (45mm)	85,49
<b>SolidFoot VibroMat 500H</b> (45mm)	115,36
<b>SolidFoot AV Pads 300L</b> (6mm)	57,68
<b>SolidFoot AV Pads 500L</b> (6mm)	73,13

Typ • Type	Cena [PLN/szt.] • Price [PLN/pc]
<b>SolidFoot Angled Pads 305</b> 2.5°	86,52
<b>SolidFoot Angled Pads 500</b> 2.5°	99,91
<b>SolidFoot Angled Pads 305</b> 5°	86,52
<b>SolidFoot Angled Pads 500</b> 5°	99,91

### SolidFoot Quad\*

System wspornikowy do montażu ciężkich urządzeń HVAC na dachach płaskich.

• *Support systems for heavy duty units.*



Typ • Type	Wymiary • Dimensions [mm]	Cena [PLN/szt.] • Price [PLN/pc]
<b>SolidFoot Quad 305</b>	305×305	1 189,65
<b>SolidFoot Quad 500</b>	500×500	2 081,63

### SolidFoot DA\*

Podstawa do przewodów z regulacją wysokości.

• *Duct adjuster*



Typ • Type	Wymiary • Dimensions [mm]	Cena [PLN/szt.] • Price [PLN/pc]
<b>SolidFoot DA 305</b>	305×305	1 031,03
<b>SolidFoot DA 500</b>	500×500	629,33

\* Na zamówienie • *On request*

## Big Foot H Frame Sets

Niepenetrujące wsporniki do instalacji rurowych, przewodów wentylacyjnych oraz drabinek i kanałów kablowych. • *Non-penetrative supports for pipework, duct and cable ladder/tray.*

Typ • Type	Cena [PLN/opak.] • Price [PLN/pack.]
<b>H Frame Set 305 mm</b> Zalecane obciążenie ramy • <i>Rec. frame load:</i> 300 kg Zawartość zestawu: • <i>Kit includes:</i> 2 X STOPY ZE ZINTEGROWANĄ MATĄ • <i>FEET WITH ADHERED MAT</i> 4 X WSPORNIKI I OSPRZĘT • <i>BRACKETS AND FIXINGS</i> 1 X INSTRUKCJA MONTAŻU • <i>ASSEMBLY INSTRUCTIONS</i>	405,82
<b>H Frame Set 305 mm, 5 Pack</b> Zalecane obciążenie ramy • <i>Rec. frame load:</i> 300 kg Zawartość zestawu: • <i>Kit includes:</i> 2 X STOPY ZE ZINTEGROWANĄ MATĄ • <i>FEET WITH ADHERED MAT</i> 4 X WSPORNIKI I OSPRZĘT • <i>BRACKETS AND FIXINGS</i> 1 X INSTRUKCJA MONTAŻU • <i>ASSEMBLY INSTRUCTIONS</i>	1 891,08 (378,22 za zestaw)
<b>H Frame Set 450 mm</b> Zalecane obciążenie ramy • <i>Rec. frame load:</i> 500 kg Zawartość zestawu: • <i>Kit includes:</i> 2 X PLASTIKOWE STOPY • <i>PLASTIC FEET</i> 2 X KAUCZUKOWE MATY • <i>RUBBER MATS</i> 2 X WKŁADKA • <i>INSERT</i> 2 X WSPORNIKI I OSPRZĘT • <i>BRACKETS AND FIXINGS</i> 1 X INSTRUKCJA MONTAŻU • <i>ASSEMBLY INSTRUCTIONS</i>	868,29
<b>H Frame Set 600 mm*</b> Zalecane obciążenie ramy • <i>Rec. frame load:</i> 500 kg Zawartość zestawu: • <i>Kit includes:</i> 2 X PLASTIKOWE STOPY • <i>PLASTIC FEET</i> 2 X KAUCZUKOWE MATY • <i>RUBBER MATS</i> 2 X WKŁADKA • <i>INSERT</i> 2 X WSPORNIKI I OSPRZĘT • <i>BRACKETS AND FIXINGS</i> 1 X INSTRUKCJA MONTAŻU • <i>ASSEMBLY INSTRUCTIONS</i>	1 387,41



UWAGA: Drażki NIE są częścią zestawu. • *PLEASE NOTE: Strut NOT included.*

## Big Foot Multi Foot

Niepenetrujące wsporniki do instalacji rurowych, kanałów wentylacyjnych oraz kanałów kablowych. • *Non-penetrative supports for pipework, duct and cable ladder/tray.*

Typ • Type	Maks. obciążenie • <i>Max. loading</i> [kg]	Cena [PLN/opak.] • Price [PLN/pack.]
<b>Multi Foot 400mm, 4 Pack</b>	259	639,63
<b>Multi Foot 600mm 3 Pack</b>	474	773,53



\* Na zamówienie • *On request*



## Big Foot Fix-it Foot

Niepenetrujące wsporniki do instalacji rurowych, kanałów wentylacyjnych oraz kanałów kablowych.

• Non-penetrative supports for pipework, duct and cable tray.

Typ • Type	Maksymalne obciążenie • Max. load [kg]	Cena [PLN/szt.] • Price [PLN/pc]
<b>Fix-it Foot 250*</b> (250×180×95 mm)	82	119,48
<b>Fix-it Foot 400</b> (400×180×95 mm)	128	154,50
<b>Fix-it Foot 600</b> (600×180×95 mm)	224	176,13
<b>Fix-it Foot 1000*</b> (1000×180×95 mm)	295	386,25



Typ • Type	Maksymalne obciążenie • Max. load [kg]	Cena [PLN/szt.] • Price [PLN/pc]
<b>Fix-it Foot Low 250*</b> (250×130×50 mm)	82	95,79
<b>Fix-it Foot Low 400*</b> (400×130×50 mm)	128	123,60
<b>Fix-it Foot Low 600*</b> (600×130×50 mm)	134	140,08

Typ • Type	Cena [PLN/zestaw] • Price [PLN/kit]
<b>Fix-it Foot Mini Split Kit 600 mm*</b> (600 mm x 180 mm x 95 mm) z zestawami montażowymi / with fixings Maks. obciążenie • Max. load: 448 kg	497,49
<b>Fix-it Foot Mini Split Kit 1000 mm*</b> (1000 mm x 180 mm x 95 mm) z zestawami montażowymi / with fixings Maks. obciążenie • Max. load: 590 kg	959,96

\* Na zamówienie • On request

## Vibromats

W sytuacjach, gdy nie trzeba montować pomostów, te wykonane ze skompresowanego kauczuku z odzysku maty, dostępne w 3 rozmiarach, można ułożyć bezpośrednio na dachu. • Where elevated walkways are not required these compressed recycled rubber mats, in 3 size options, can be laid directly onto the roof top.



Typ • Type	Wymiar • Dimension [mm]	Cena [PLN/szt.] • Price [PLN/pc]
<b>Mała płyta*</b> • Small Tile	600 x 150 x 30	129,78
<b>Duża płyta*</b> • Large Tile	1000 x 500 x 30	304,88
<b>Zwykła płyta*</b> • Plain Tile	500 x 500 x 45	129,78
<b>AV Strip*</b>	1000 x 75 x 15	93,73

## Mounting Platforms

Zamontowane na wkładkach Big Foot platformy stanowią niezwykle uniwersalny system wsporników. • Simply fitted into the top of the Big Foot mouldings, these Platforms provide a versatile support system.

Typ • Type	Cena [PLN/zestaw] • Price [PLN/kit]
<b>305 mm płaskie*</b> • Plain Top	567,53
<b>305 mm 2 ścianki*</b> • Plain Top	567,53
<b>305 mm 4 ścianki*</b> • Plain Top	567,53
<b>450 mm płaskie*</b> • Plain Top	1 051,63
<b>450 mm 2 ścianki*</b> • Plain Top	1 051,63
<b>450 mm 4 ścianki*</b> • Plain Top	1 051,63



**Zawartość zestawu:** • Kit includes:  
 2 X PODNOŻKI Z PLATFORMĄ • PLATFORM  
 2 X STOPA Z TWORZYWA SZTUCZNEGO • PLASTIC FOOT  
 1 X KAUCZUKOWA MATA • RUBBER MAT

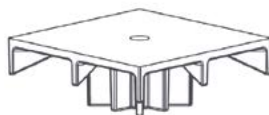

Płaski



2 ścianki

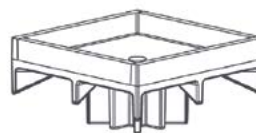

4 ścianki

\* Na zamówienie • On request

### Big Foot Standard Frames

Niepenetrujące ramy wspornikowe do minisplitów, niewielkich jednostek VRF, małych centrali wentylacyjnych i wyciągów.

• Non-penetrative support frames for air conditioning mini splits, VRFs, small AHUs, supply and extract fans.

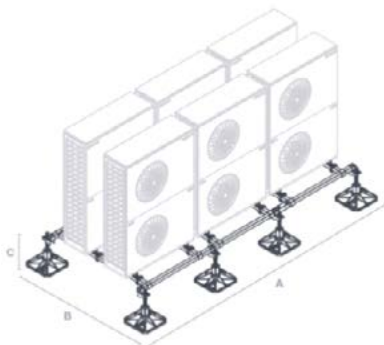

Zawartość zestawu: • Kit includes:

KSZTAŁTOWNIKI KOŃCOWE O PRZEKROJU SKRZYNKOWYM I WYMIARACH 40×40 mm • 40×40 mm BOX SECTION END BARS

KSZTAŁTOWNIKI POPRZECZNE O DŁ. 1,2 m I PRZEKROJU 40×40 mm • 1,2 m CROSS BARS - 40×40 mm SECTION

ZESTAWY NÓG ZE STOPAMI 305 mm I ZAMOCOWANYMI KAUCZUKOWYMI MATAMI • 305 mm LEG ASSEMBLIES WITH ADHERED RUBBER MATS

ZESTAWY ZACISKÓW • CLAMP KITS

INSTRUKCJA MONTAŻU • ASSEMBLY INSTRUCTIONS

Typ • Type	Wymiar (A×B×C) • Dimension [mm]	Maks. obciążenie • Max. loading [kg]	Cena [PLN/zestaw] • Price [PLN/kit]
Rama modułowa, 1 m • 1 m Modular Frame	1000×1200×290-400	480	2 016,74
Rama modułowa, 2 m • 2 m Modular Frame	2000×1200×290-400	720	2 814,99
Rama modułowa, 3 m • 3 m Modular Frame	3000×1200×290-400	960	3 963,44

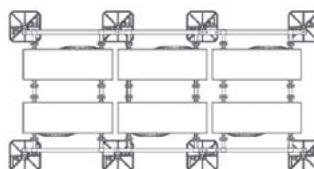
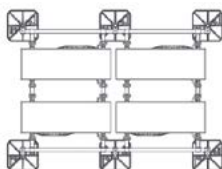
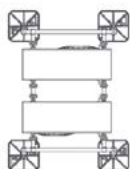
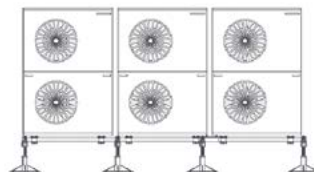
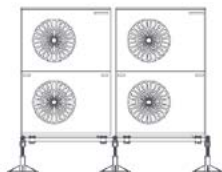

1 m / 2 urządzenia

2 m / 4 urządzenia

3 m / 6 urządzeń



## Drut miedziany • Copper wire

Drut miedziany do zgrzewania liniowego ciągłego lub ścięciem pojedynczym elementów o średnicy 1,8 mm lub 2,0 mm. • Copper wire for linear welding (continuous or stitch) in diameter of 1.8 mm or 2.0 mm.



Grubość • Thickness [mm]	Waga • Weight [kg]	Cena [PLN/kg] • Price [PLN/kg]
1,8	1000 (+/- 5%)	CENA NA ZAPYTANIE
2,0	1000 (+/- 5%)	CENA NA ZAPYTANIE

## Profil kanałowy ocynkowany • Ductwork profile (galvanized steel)

DW



## Narożnik ocynkowany do profili kanałowych • Corner (galvanized steel)

H

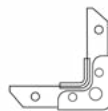

Typ • Type	Długość [mb] • Length [m]	Cena [PLN/mb] • Price [PLN/m]	
		1-5000 m	> 5000 m
DW-20	3	8,96	3,61
	5		
DW-30	3	10,82	4,84
	5		
DW-40	3	15,55	10,30
	5		

Typ • Type	Opak. [szt.] • Pack. [pcs]	Cena [PLN/szt.] • Price [PLN/pc]	
		1-5000 szt. • pc	> 5000 szt. • pc
H-20	1	1,55	0,52
H-20 KRÓTKI	1	1,44	0,52
H-20 DŁUGI	1	1,85	0,72
H-30	1	3,09	1,44
H-40	1	6,28	2,99

## Profil kanałowy - stal kwasoodporna • Ductwork profile (stainless steel)

DW INOX



## Narożnik ze stali kwasoodpornej do profili kanałowych • Corner (stainless steel)

H INOX



Typ • Type	Długość [mb] • Length [m]	Cena [PLN/mb] • Price [PLN/m]
DW-20 INOX*	5	105,27
DW-30 INOX*	5	134,42

Typ • Type	Opak. [szt.] • Pack. [pcs]	Cena [PLN/szt.] • Price [PLN/pc]
H-20 INOX*	1	16,48
H-30 INOX*	1	36,05

\* Do zamówień powyżej 500 mb oferujemy duże rabaty • For orders above 500 meters we offer large discounts.

## MATERIAŁY PRODUKCYJNE

Siatka, rurka usztywniająca, dysk/krzyżak usztywniający, cynk w sprayu

• Mesh, stiffening aluminium pipe, stiffening disc and cross, Alu-Zinc spray



### Siatka ocynkowana 12×12

• Galvanized steel 12x12 mesh



Rolka • Roll [m <sup>2</sup> ]	Cena [PLN/m <sup>2</sup> ] • Price [PLN/m <sup>2</sup> ]
15	77,04

### Rurka usztywniająca aluminiowa

• Stiffening aluminium pipe

**RUO**



Wymiary • Dimensions [mm]	Cena [PLN/mb] • Price [PLN/m]
16 × 6000	23,79

### Dysk usztywniający

• Stiffening disc

**DU**

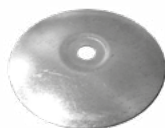

Opakowanie [szt.] • Package [pcs]	Cena [PLN/opak.] • Price [PLN/-pack.]
1000	1 275,66

### Krzyżak usztywniający stalowy

• Stiffening steel cross

**KUS**



Opakowanie [szt.] • Package [pcs]	Cena [PLN/mb] • Price [PLN/m]
100	528,18

### Spray cynkowy Alucynk

• Alu-Zinc spray

**Alz 600**



Opakowanie • Package [ml]	Cena [PLN/m <sup>2</sup> ] • Price [PLN/m <sup>2</sup> ]
500	61,70

### Masa uszczelniająca Vergacol

• "Vergacol" tightening compound

**VG**



Opakowanie • Package [ml]	Cena [PLN/mb] • Price [PLN/m]
310	57,68

## MATERIAŁY PRODUKCYJNE

Mechanizmy przepustnicy, trzpienie, masy uszczelniające, łączniki elastyczne

• Damper mechanisms, bolts, tightening compound, flexible connectors

**Centrum  
Klima**



### Mechanizm przepustnicy AC-006

• AC-006 damper mechanism

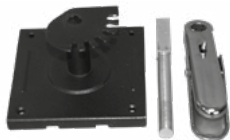

Opakowanie [szt.] • Package [pcs]	Cena [PLN/szt.] • Price [PLN/pc]
1	34,51

### Mechanizm przepustnicy SPIRO

• SPIRO damper mechanism



Typ • Type	Opak. [szt.] • Package [pcs]	Cena [PLN/szt.] • Price [PLN/pc]
<b>SPIRO</b>	1	20,70

### Mechanizm przepustnicy

• Damper mechanism

**RS 356**

Typ • Type	Opak. [szt.] • Package [pcs]	Cena [PLN/szt.] • Price [PLN/pc]
<b>RS 356</b>	1	6,28

### Masa uszczelniająca

• Tightening compound

**DW 601**



Opakowanie [kg] • Package [kg]	Cena [PLN/opak.] • Price [PLN/package]
6	383,16

### Łącznik elastyczny

• Flexible connector

**LE**



Typ • Type	Opak. • Pack. [m]	Cena [PLN/opak.] • Price [PLN/package]
XEV-50 PVC 35/60/35	50	1 051,32
KEV-50 PVC 45/60/45	50	1 083,05
EEV-100 PVC 70/100/70	50	932,05
XSI-25 35/60/35* silikonowy • silicone	25	929,68
JSI-25 45/75/45* silikonowy • silicone	25	1 080,68
ESI-100 70/100/70 silikonowy • silicone	30,5	1 569,82
JPL-100 45/75/45 poliuretanowy • polyurethane	30,5	1 581,87
EPL-100 70/100/70 poliuretanowy • polyurethane	30,5	1 747,50

<sup>1</sup> Na zapytanie • for enquiry

### Trzpienie mechanizmu przepustnicy

• Damper bolts



Typ • Type	Cena [PLN/szt.] • Price [PLN/pc]
BKP 6	4,33
BKP 7	5,97



### Mechanizm przepustnicy

• Damper mechanism

**KSR**  
195



Typ • Type	Opak. [szt.] • Package [pcs]	Cena [PLN/szt.] • Price [PLN/pc]
<b>KSR 195</b> zestaw • set	1	12,88

### Mechanizm przepustnicy

• Damper mechanism

**MD**



Typ • Type	Opak. [szt.] • Package [pcs]	Cena [PLN/szt.] • Price [PLN/pc]
<b>MD</b>	1	28,33

### Mechanizm przepustnicy

• Damper mechanism

**KS**



Typ • Type	Opak. [szt.] • Package [pcs]	Cena [PLN/szt.] • Price [PLN/pc]
<b>KS 12</b> zestaw • set	1	18,03
<b>KS 145</b>	1	7,73
<b>KS 385</b> zestaw • set	1	20,60

### Rączka mechaniczna przepustnicy

• Damper hand



Cena [PLN/szt.] • Price [PLN/pc]
8,55

### Łącznik kierownicy kolana wentylacyjnego

• Turning vane guide for rectangular duct

**LKK**



Opakowanie [szt.] • Package [pcs]	Cena [PLN/opak.] • Price [PLN/pack.]
100	141,83



## Kołnierz • Flange

VKPK



Średnica • Diameter D [mm]	Cena [PLN/szt.] • Price [PLN/pc]
80	41,41
100	29,77
110	44,81
125	35,33
140	50,06
150	53,77
160	37,90
180	56,55
200	40,89
224	60,56
250	56,75
315	62,62
355	74,88
400	92,29
450	111,03
500	130,09
560	156,15
630	182,52
710	298,39
800	245,55

## Tuleja • Bushing

BKP



Typ • Type	Opak. [szt.] • Package [pcs]	Cena [PLN/szt.] • Price [PLN/pc]
<b>BKP-9</b> MOSIĘŻNA • BRASS	10	2,78
<b>BKP-10</b> MOSIĘŻNA • BRASS	10	2,78

## Nit aluminiowo-stalowy

• Aluminum-steel rivets



Typ • Type	Opak. [szt.] • Package [pcs]	Cena [PLN/opak.] • Price [PLN/pack.]
<b>39/06</b>	1000	134,72
<b>39/08</b>	1000	139,57





### Przepustnica wielopłaszczyznowa aluminiowa • Aluminium multi-leaf damper

PWT

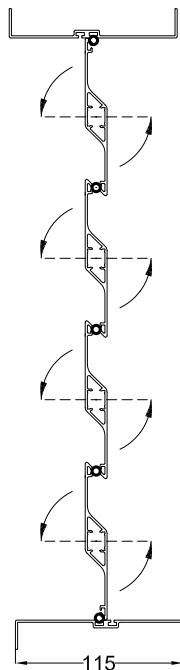
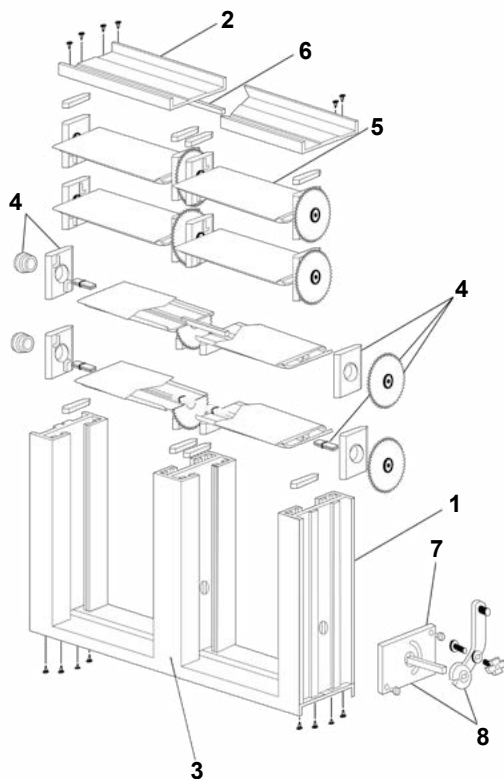

1	PS 120	Profil lewy-prawy, długość 5,8 m • Left-right profile, length 5,8 m	103,62 PLN/mb
2	PS 110	Profil górny-dolny, długość 5,8 m • Upper-bottom profile, length 5,8 m	62,52 PLN/mb
3	PS 130	Profil środkowy, długość 5,8 m • Central profile, length 5,8 m	153,37 PLN/mb
4	CPS 2007	Mechanizm koła zębatego • Mechanism	33,89 PLN/kpl. • set
5	PS 100TT	Pióro przepustnicy, długość 5,8 m • Damper blade, length 5,8 m	125,25 PLN/mb
6	GA12T	Uszczelka • Gasket	4,94 PLN/mb
7	BKP7	Trzpień • Pivot	7,31 PLN/szt. • pc
8	RDP	Rączka mechaniczna przepustnicy • Damper hand	10,20 PLN/kpl. • set



### Przepustnica wielopłaszczyznowa aluminiowa • Aluminium multi-leaf damper

PW

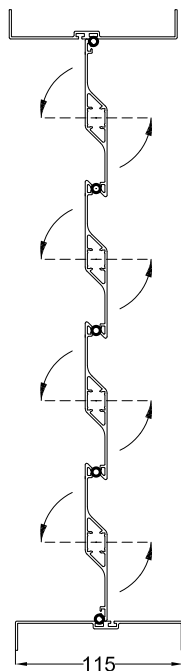
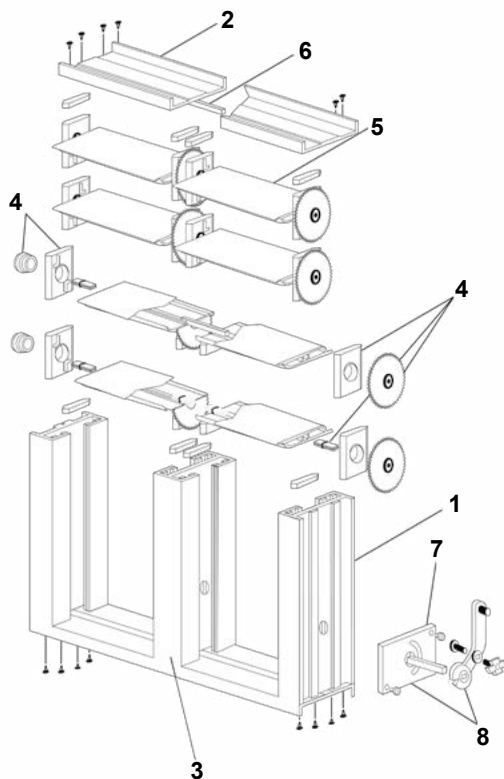

1	PS 120	Profil lewy-prawy, długość 5,8 m • Left-right profile, length 5,8 m	103,62 PLN/mb
2	PS 110	Profil górny-dolny, długość 5,8 m • Upper-bottom profile, length 5,8 m	62,52 PLN/mb
3	PS 130	Profil środkowy, długość 5,8 m • Central profile, length 5,8 m	153,37 PLN/mb
4	CPS 93	Mechanizm koła zębatego • Mechanism	27,60 PLN/kpl. • set
5	PS 100	Pióro przepustnicy, długość 5,8 m • Damper blade, length 5,8 m	125,25 PLN/mb
6	GA12T	Uszczelka • Gasket	4,94 PLN/mb
7	BKP7	Trzpień • Pivot	7,31 PLN/szt. • pc
8	RDP	Rączka mechaniczna przepustnicy • Damper hand	10,20 PLN/kpl. • set



### Czerpnia/wyrzutnia prostokątna aluminiowa

• Aluminium rectangular air intake/exhauster

CWA

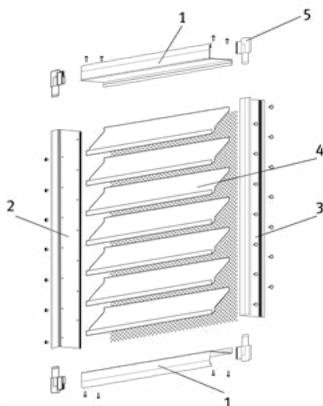

1	P-GR050-BA	Profil górny-dolny, długość 5,8 m • Upper-bottom profile, length 5,8 m	50,47 PLN/mb
2	P-GR050-SS	Profil lewy, długość 5,8 m • Left profile, length 5,8 m	116,29 PLN/mb
3	P-GR050-SD	Profil prawy, długość 5,8 m • Right profile, length 5,8 m	116,29 PLN/mb
4	P-GR050-PA	Lamela, długość 5,8 m • Louvre, length 5,8 m	37,39 PLN/mb
5	AZ-GR S	Narożnik lewy-prawy • Left-right corner	47,07 PLN/2szt. • 2pcs

### Czerpnia/wyrzutnia prostokątna stalowa ocynkowana

• Rectangular air intake/exhauster, galvanized steel

CW

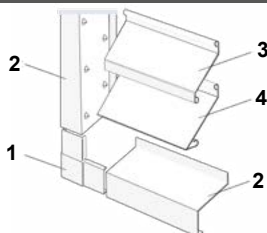

1	BR 40	Narożnik • Corner	4,22 PLN/szt. • pc
2	BR 40/62	Profil ramy, długość 5 m • Frame profile, length 5 m	27,50 PLN/mb
3	LP 66	Profil lameli czerpni, długość 5 m • Louvre profile, length 5 m	19,98 PLN/mb
4	LP 88	Profil lameli okapnika, długość 5 m • Drip louvre profile, length 5 m	28,53 PLN/mb



## Przepustnica samoczynna aluminiowa kanałowa/ścienna

• Duct and wall automatic aluminium dampers

PSK / PSS

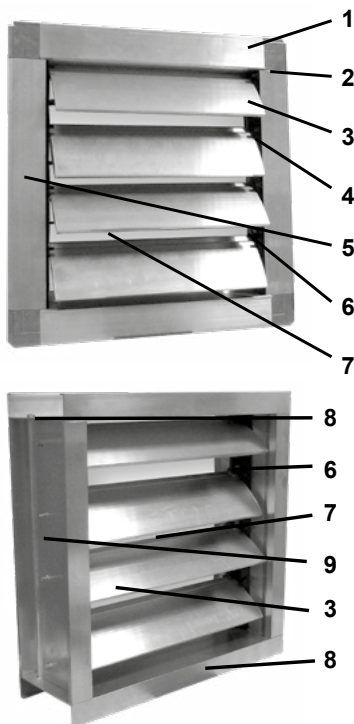

1	P-GR050-BA	Profil górny-dolny, długość 5,8 m • Upper-bottom profile, length 5,8 m	45,32 PLN/mb
2	AZ-GR S	Narożnik lewy-prawy • Left-right corner	47,07 PLN/mb
3	PK-ALU	Lamela żaluzji • Shutter louvre	61,08 PLN/mb
4	P-GR050-SD	Profil prawy, długość 5,8 m • Right profile, length 5,8 m	104,55 PLN/mb
5	P-GR050-SS	Profil lewy, długość 5,8 m • Left profile, length 5,8 m	104,55 PLN/mb
6	FK-ALU	Ramka • Frame	57,58 PLN/szt. • pc
7		Uszczelka • Gasket	4,12 PLN/mb
8	PS 120	Profil górny-dolny, długość 5,8 m • Upper-bottom profile, length 5,8 m	103,62 PLN/mb
9	PS 110	Profil lewy-prawy, długość 5,8 m • Left-right profile, length 5,8 m	62,52 PLN/mb



**Nacinarka**

• Hand notcher

**HN1V**



Cena [PLN/szt.] • Price [PLN/pc]

384,09

**Krępownica 3 ostrza**

• 3-blade hand crimper

**HC3V**



Cena [PLN/szt.] • Price [PLN/pc]

236,49

**Krępownica 5 ostrzy**

• 5-blade hand crimper

**HC5V**



Cena [PLN/szt.] • Price [PLN/pc]

252,66

**Zaginarka**

• Hand seamer

**HS1V**



Cena [PLN/szt.] • Price [PLN/pc]

434,56

**Zaginarka kątowa**

• Offset hand seamer

**HS2**



Cena [PLN/szt.] • Price [PLN/pc]

471,02

**Nożyce proste lewe**

• Scissors, left

**M1R**



Cena [PLN/szt.] • Price [PLN/pc]

212,18

**Nożyce proste prawe**

• Scissors, right

**M2R**



Cena [PLN/szt.] • Price [PLN/pc]

212,18

**Nożyce proste**

• Scissors, straight

**M3R**



Cena [PLN/szt.] • Price [PLN/pc]

202,09



**Nożyce do krzywizn lewych**

• *Offset snipes, left*

**M6R**



Cena [PLN/szt.] • Price [PLN/pc]

222,38

**Nożyce do krzywizn prawych**

• *Offset snipes, right*

**M7R**



Cena [PLN/szt.] • Price [PLN/pc]

222,38



**VENTwool** to maty lamelowe wykonane z wełny mineralnej pokrytej zbrojoną folią aluminiową. Wszystkie produkty dostępne w ramach tej nowej marki zostały od podstaw zaprojektowane z myślą o optymalnej izolacji termicznej przewodniczących wentylacyjnych i urządzeń HVAC. Produkt jest dostępny również w wersji z warstwą samoprzylepną (**VENTwool Plus**).

Szerokość rolki: 1000 mm

Gęstość: 35 kg/m<sup>3</sup>

Współczynnik przewodnictwa ciepła  $\lambda$  (10°C): 0,038

Zgodność z normą: PN-EN 14303+A1:2013-07

*VENTwool are lamella mats made of mineral wool covered with reinforced aluminum foil. All products available under this new brand have been designed for optimal thermal insulation of ventilation ducts and HVAC devices. The product is also available in a version with a self-adhesive layer (VENTwool Plus).*

*Roll width: 1000 mm*

*Density: 35 kg/m<sup>3</sup>*

*Thermal conductivity  $\lambda$  (10 °C): 0.038*

*Compliance with the norm: PN-EN 14303 + A1: 2013-07*

## VENTWOOL

Grubość • Thickness [mm]	Cena [PLN/m <sup>2</sup> ] • Price [PLN/m <sup>2</sup> ]
20	13,20
30	15,10
40	18,20
50	21,60
80	32,10
100	40,70

## VENTWOOL PLUS

Grubość • Thickness [mm]	Cena [PLN/m <sup>2</sup> ] • Price [PLN/m <sup>2</sup> ]
20	23,60
30	26,10
40	32,90
50	37,30
80	50,50
100	58,40



## ALU LAMELLA MAT



Maty LAMELLA MAT przeznaczone są do izolacji termicznej oraz przeciwkondensacyjnej kanałów wentylacyjnych i klimatyzacyjnych. Stosowane są również jako izolacja niskotemperaturowych rur, rurociągów, etc.

*Lamella Mat mats are used for technical insulations and low-temperature insulations for ventilation and air conditioning installations. Used to insulate ducts, pipelines, etc.*

Gęstość • Density: 36 kg/m<sup>3</sup>

Grubość • Thickness [mm]	Cena [PLN/m <sup>2</sup> ] • Price [PLN/m <sup>2</sup> ]
20	11,65
30	13,63
40	16,43
50	19,30
60	26,10
80	27,28
100	36,37

## CONLIT 150 P

Gęstość • Density: 165 kg/m<sup>3</sup>



Grubość • Thickness [mm]	Cena [PLN/m <sup>2</sup> ] • Price [PLN/m <sup>2</sup> ]
20	40,54
30	47,26
40	59,05
50	65,59
60	88,71
100	141,85
120	173,57
150	212,94

## KLIMAFIX



Mata KLIMAFIX przeznaczona jest do izolacji termicznej, akustycznej i przeciwkondensacyjnej kanałów wentylacyjnych i klimatyzacyjnych o dowolnym przekroju np. prostokątnym, kołowym itp. Użycie maty KLIMAFIX pomaga skrócić czas montażu izolacji nawet do 40%.

*Klimafix mats are applicable to thermal, acoustic, and low-temperature insulation of ventilation and air conditioning ducts of any diameter and shape. Using Klimafix should decrease assembly time up to 40%.*

Grubość • Thickness [mm]	Cena [PLN/m <sup>2</sup> ] • Price [PLN/m <sup>2</sup> ]
20	22,67
30	24,54
40	30,55
50	34,84

## CONLIT PLUS 60 ALU



Klasa zabezp.	Grubość • Thickness [mm]	Cena [PLN/m <sup>2</sup> ] • Price [PLN/m <sup>2</sup> ]
EIS 30 / EIS 60	60	138,10
EIS 90 / EIS 120	60	207,00





**PROROX SL**



Grubość • Thickness [mm]	Cena [PLN/m <sup>2</sup> ] • Price [PLN/m <sup>2</sup> ]		
	930 (55 kg/m <sup>3</sup> )	950 (80 kg/m <sup>3</sup> )	960 (100 kg/m <sup>3</sup> )
<b>50</b>	19,90	24,65	30,35
<b>60</b>	21,96	30,37	35,92
<b>80</b>	31,09	39,88	49,32
<b>100</b>	37,91	48,84	60,51

**PROROX WM**



Grubość • Thickness [mm]	Cena [PLN/m <sup>2</sup> ] • Price [PLN/m <sup>2</sup> ]			
	ProRox WM 950	ProRox WM 960	ProRox WM 950 ALU	ProRox WM 960 ALU
	80 kg/m <sup>3</sup>	100 kg/m <sup>3</sup>	80 kg/m <sup>3</sup>	100 kg/m <sup>3</sup>
<b>30</b>	x	25,81	x	x
<b>40</b>	28,83	31,71	x	x
<b>50</b>	32,04	36,19	41,20	45,51
<b>60</b>	36,19	41,99	x	x
<b>80</b>	43,42	52,44	x	x
<b>100</b>	53,20	61,96	63,30	73,75

**PROROX WM 920**

Gęstość • Density: 60 kg/m<sup>3</sup>



Grubość • Thickness [mm]	Cena [PLN/m <sup>2</sup> ] • Price [PLN/m <sup>2</sup> ]
<b>50</b>	26,88
<b>60</b>	29,84
<b>80</b>	38,69
<b>100</b>	46,93

**PROROX LF 970<sup>PL</sup>**



Cena [PLN/kg] • Price [PLN/kg]
7,58

**CONLIT GLUE**



Opakowanie • Package	Cena [PLN/opak.] • Price [PLN/pack.]
20 kg (wiadro • can)	241,75



## PROROX MA 520 ALU

Gęstość • Density: 60 kg/m<sup>3</sup>



Grubość • Thickness [mm]	Cena [PLN/m <sup>2</sup> ] • Price [PLN/m <sup>2</sup> ]
50	48,75
100	99,96

## SILKROCK



Grubość • Thickness [mm]	Cena [PLN/m <sup>2</sup> ] • Price [PLN/m <sup>2</sup> ]
50	56,50
100	85,00

## FIREROCK

Gęstość • Density: 80 kg/m<sup>3</sup>



Grubość • Thickness [mm]	Cena [PLN/m <sup>2</sup> ] • Price [PLN/m <sup>2</sup> ]
25	47,77
30	51,07

## PROROX SL 970

Gęstość • Density: 120 kg/m<sup>3</sup>



Grubość • Thickness [mm]	Cena [PLN/m <sup>2</sup> ] • Price [PLN/m <sup>2</sup> ]
50	61,77
100	92,48

## INDUSTRIAL BATTS BLACK

Platy INDUSTRIAL BATTS BLACK przeznaczone są do izolacji termicznej i akustycznej kanałów wentylacyjnych na powierzchniach wewnętrznych. Mają również zastosowanie jako izolacja akustyczna tłumików szczeliniowych i komorowych oraz ekranów dźwiękochłonnych.

*INDUSTRIAL BATTS BLACK are applicable to thermal and acoustic insulation of inside surfaces. They are also applicable for acoustic insulation of silencers and for attenuating screens.*



Grubość • Thickness [mm]	Długość/szerokość • Length/width [mm]		
	2000/1200	2000/1200	2000/1200
60 kg/m <sup>3</sup>	60 kg/m <sup>3</sup>	60 kg/m <sup>3</sup> PODWÓJNY WIELON • DUAL-LAYER VEIL	80 kg/m <sup>3</sup>
Cena [PLN/m <sup>2</sup> ] • Price [PLN/m <sup>2</sup> ]			
15	x	x	30,91
20	x	x	33,07
30	35,52	x	x
50	39,70	47,53	x
100	62,00	74,55	x



## OTULINA ROCKWOOL 800



Otulina z wełny skalnej produkowana w unikalnej technologii, dzięki której posiada doskonałe parametry techniczne, wyjątkową jakość i trwałość izolacji.

D [mm]	Grubość • Thickness [mm]				
	20	30	40	50	60
Cena [PLN/mb] • Price [PLN/m]					
DOSTARCZANA NA PALETACH					
18	6,45	9,62	12,24	×	×
22	6,92	9,71	14,26	17,81	20,92
28	7,29	9,93	14,68	18,17	22,22
35	7,59	11,03	15,75	19,59	24,35
42	8,17	11,44	16,40	19,92	26,91
48	8,40	11,72	16,81	22,35	27,95
54	8,96	12,66	18,98	24,30	29,01
60	9,30	12,92	19,72	23,45	29,17
64	11,10	14,07	20,58	24,80	33,94
70	×	14,63	21,19	26,82	35,03
DOSTARCZANA W KARTONACH					
18	7,08	10,10	12,73	×	×
22	7,61	10,68	15,68	19,60	23,01
28	8,02	10,94	16,15	20,00	24,46
35	8,35	12,15	17,33	21,55	26,79
42	8,97	12,60	18,04	21,91	29,60
48	9,25	12,88	18,47	24,57	30,74
54	9,87	13,94	20,89	26,72	31,89
60	10,25	14,21	21,71	25,79	32,09
64	12,21	15,48	22,63	27,28	37,30
70	×	16,10	23,31	29,47	38,55

## ROCKLIT



Do wypełniania przejść instalacyjnych przez stropy i ściany oddzielań przeciwpożarowych.

To fill in holes while the installation is crossing floors and walls.

Długość • Length [mm]	1000
Szerokość • Width [mm]	600
Grubość • Thickness [mm]	60
Ilość szt. w paczce • Quantity in package [pcs]	4
Ilość m <sup>2</sup> w paczce • Quantity in package [m <sup>2</sup> ]	2,4
Cena [PLN/m <sup>2</sup> ] • Price [PLN/m]	<b>68,34</b>



## Gwoździe samoprzylepne • Self-adhesive nails

GS

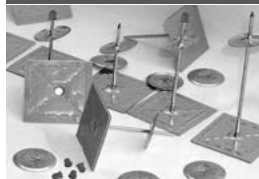

Gwoździe samoprzylepne służą do mechanicznego zamocowania materiałów izolacyjnych na gładkiej powierzchni przewodów wentylacyjnych. Zastosowanie w zakresie temperatury od -40°C do +80°C (w krótkim czasie do 100°C).

*Self-adhesive nails are used for the mechanical fastening of the insulation materials at the smooth surface of the ventilation ducts. Usage in the temperature range from -40°C to +80°C (and in the very short time also to 100°C).*

Typ • Type	Opakowanie [szt.] • Package [pcs]	Cena [PLN/opak.] • Price [PLN/pack.]
<b>Gwoździe uniwersalne samoprzylepne FSG-250</b> • Universal self-adhesive nails FSG-250	100	136,37
<b>Gwoździe samoprzylepne z blaszkami - 25 mm</b> • Self-adhesive nails with plates - 25 mm	100	67,88
<b>Gwoździe samoprzylepne z blaszkami - 32 mm</b> • Self-adhesive nails with plates - 32 mm	100	69,32
<b>Gwoździe samoprzylepne z blaszkami - 44 mm</b> • Self-adhesive nails with plates - 44 mm	100	72,72
<b>Gwoździe samoprzylepne z blaszkami - 51 mm</b> • Self-adhesive nails with plates - 51 mm	100	80,86
<b>Gwoździe samoprzylepne z blaszkami - 63 mm</b> • Self-adhesive nails with plates - 63 mm	100	86,31
<b>Gwoździe samoprzylepne z blaszkami - 89 mm</b> • Self-adhesive nails with plates - 89 mm	100	92,39
<b>Gwoździe samoprzylepne z blaszkami - 114 mm</b> • Self-adhesive nails with plates - 114 mm	100	109,80
<b>Blaszki do gwoździ EC-30</b> • Plates for nails EC-30	1000	156,66
<b>Kapturek nylonowy EP-32</b> • Nylon cap EP-32	1000	84,36

**Gwoździe do zgrzewania • Nails for the spinspace**

**DO WYCZERPANIA ZAPASÓW!**

Gwoździe do zgrzewania służą do mechanicznego zamocowania materiałów izolacyjnych na gładkiej powierzchni przewodów wentylacyjnych. Zastosowanie w zakresie temperatury od -40°C do +80°C (w krótkim czasie do 100°C).

*Welding nails are used for mechanical fixing of insulation materials on smooth surfaces of ventilation ducts. To be used within temperature range from -40°C to +80°C (for a short time up to 100°C).*

Typ • Type	Opakowanie [szt.] • Package [pcs]	Cena [PLN/opak.] • Price [PLN/pack.]
<b>Gwoździe do zgrzewarki PN34 - 19 mm</b> • Welding nails PN34 - 19 mm	100	98,47
<b>Gwoździe do zgrzewarki PN100 - 25 mm</b> • Welding nails PN100 - 25 mm	100	78,38
<b>Gwoździe do zgrzewarki PN114 - 32 mm</b> • Welding nails PN114 - 32 mm	100	95,48
<b>Gwoździe do zgrzewarki PN134 - 44 mm</b> • Welding nails PN134 - 19 mm	100	109,08
<b>Gwoździe do zgrzewarki PN200 - 51 mm</b> • Welding nails PN200 - 19 mm	100	129,68
<b>Gwoździe do zgrzewarki PN250 - 63 mm</b> • Welding nails PN250 - 19 mm	100	143,27
<b>Gwoździe do zgrzewarki PN350 - 89 mm</b> • Welding nails PN350 - 19 mm	100	193,33
<b>Gwoździe do zgrzewarki PN450 - 114 mm</b> • Welding nails PN450 - 114 mm	1000	324,14



Taśmy, mata termoizolacyjna samoprzylepna MST

• Tapes, thermal insulation adhesive mat MST

## Taśma aluminiowa izolacyjna

• Insulating aluminium tape



Wielkość • Size [mm]	Cena [PLN/szt.] • Price [PLN/pc]
<b>100 mm × 50 m</b>	73,34
<b>75 mm × 50 m</b>	52,43
<b>50 mm × 50 m</b>	34,09

## Taśma aluminiowa izolacyjna zbrojona

• Reinforced insulating aluminium tape

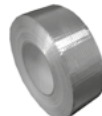

Wielkość • Size [mm]	Cena [PLN/szt.] • Price [PLN/pc]
<b>100 mm × 50 m</b>	91,77
<b>75 mm × 50 m</b>	73,74
<b>50 mm × 50 m</b>	47,22

## Taśma uniwersalna naprawcza

• Universal repair tape



Wielkość • Size [mm]	Cena [PLN/szt.] • Price [PLN/pc]
<b>50 mm × 50 m</b>	32,45

## Taśma montażowa PVC gładka

• PVC smooth assembling tape

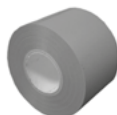

Wielkość • Size [mm]	Cena [PLN/szt.] • Price [PLN/pc]
<b>50 mm × 50 m</b>	25,65

## Taśma metalizowana PP

• PP metalized tape

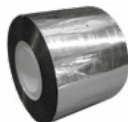

Wielkość • Size [mm]	Cena [PLN/szt.] • Price [PLN/pc]
<b>75 mm × 50 m</b>	32,34
<b>50 mm × 50 m</b>	21,84

## Mata termoizolacyjna samoprzylepna

• Thermal insulation adhesive mat

**MST**

Maty termoizolacyjne samoprzylepne MST wykonane z syntetycznej pianki kauczukowej zwijane w role o szerokości 1 m. Służą do izolowania termicznego oraz ochrony przeciwkondensacyjnej dużych przekrojów rur, zbiorników oraz wszelkiego typu armatury w instalacjach chłodniczych, klimatyzacyjnych, wentylacyjnych, grzewczych, sanitarnych, oraz instalacjach specjalnych.

Thermal insulation sticky MST mats are made of synthetic rubber foam and rolled into 1 m broad rolls. The mats are used for thermal insulation and anti-condensation protection of big diameter pipes, tanks and all types of fixtures in cooling systems, air conditioning systems, heating systems, sanitary and special purpose installations

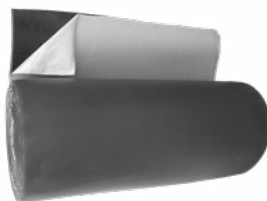

Grubość • Thickness [mm]	Szerokość • Width [m]	Opakowanie • Package [m <sup>2</sup> /rolka • roll]	Cena • Price [PLN/m <sup>2</sup> ]
<b>6</b>	1	10	88,79
<b>9</b>	1	10	102,79
<b>13</b>	1	10	121,54
<b>19</b>	1	10	147,19
<b>25</b>	1	10	203,01

**Zawór wyciągowy**

• Exhaust air valve

**SR-E**

øD [mm]	Op. <sup>*)</sup>	Cena katalogowa	Zakup > 500 szt. <sup>**)</sup>
		• Basic price	• Order > 500 pcs <sup>*)</sup>
		[PLN/szt.] • [PLN/pc]	
<b>80</b>	7	40,17	6,18
<b>100</b>	7	42,33	6,70
<b>125</b>	7	50,68	9,17
<b>150</b>	7	76,01	12,67
<b>160</b>	7	80,24	13,91
<b>200</b>	7	101,35	17,92
<b>250</b>	7	158,62	30,59

**Zawór nawiewny**

• Supply air valve

**SR-S**Dostępne również  
w kolorze**RAL 9016!**

øD [mm]	Op. <sup>*)</sup>	Cena katalogowa	Zakup > 500 szt. <sup>**)</sup>
		• Basic price	• Order > 500 pcs <sup>*)</sup>
		[PLN/szt.] • [PLN/pc]	
<b>80</b>	7	40,17	6,18
<b>100</b>	7	42,33	6,70
<b>125</b>	7	50,68	9,17
<b>150</b>	7	76,01	12,67
<b>160</b>	7	80,24	13,91
<b>200</b>	7	101,35	17,92
<b>250</b>	7	158,62	30,59

**Zawór wyciągowy z uszczelką**

• Exhaust air valve with gasket

**SR-EX**

øD [mm]	Cena katalogowa [PLN/szt.]
	• Basic price [PLN/pc]
<b>100</b>	74,06
<b>125</b>	98,47
<b>160</b>	131,63
<b>200</b>	176,95

**Zawór nawiewny z uszczelką**

• Supply air valve with gasket

**SR-SX**

øD [mm]	Cena katalogowa [PLN/szt.]
	• Basic price [PLN/pc]
<b>100</b>	74,26
<b>125</b>	98,47
<b>160</b>	127,51

\*) Ilość [szt./opak.] • Quantity [pcs/pack.]

\*\*) Rabatu za wielkość zamówienia nie można łączyć z innymi rabatami lub promocjami  
• Discount for quantity of pieces ordered cannot be added to any other discount



**Zawór wyciągowy**  
• Exhaust air valve

**NEV**



øD [mm]	Op. *)	Cena katalogowa • Basic price	Zakup > 500 szt. **) • Order > 500 pcs **)
		[PLN/szt.] • [PLN/pc]	
80	7	43,36	10,71
100	7	45,63	11,23
125	7	54,69	13,49
150	7	86,62	21,32
160	7	86,62	21,32
200	7	109,49	27,09

**Zawór nawiewny**  
• Supply air valve

**NSV**



øD [mm]	Op. *)	Cena katalogowa • Basic price	Zakup > 500 szt. **) • Order > 500 pcs **)
		[PLN/szt.] • [PLN/pc]	
80	7	43,36	10,71
100	7	45,63	11,23
125	7	54,69	13,49
150	7	86,62	21,32
160	7	86,62	21,32
200	7	109,49	27,09

**Zawór wyciągowy**  
• Exhaust air valve

**SF-E**



øD [mm]	Op. *)	Cena katalogowa • Basic price	Zakup > 60 szt. **) • Order > 60 pcs **)
		[PLN/szt.] • [PLN/pc]	
80	7	35,43	21,63
100	7	39,24	23,79
125	7	48,93	29,66
150	7	70,45	42,75
160	7	70,45	42,75
200	7	90,74	55,00
<b>Wersja z ramką SF-EF</b>			
100	7	47,17	28,53
125	7	58,61	35,54

**Zawór nawiewny**  
• Supply air valve

**SF-S**



øD [mm]	Op. *)	Cena katalogowa • Basic price	Zakup > 60 szt. **) • Order > 60 pcs **)
		[PLN/szt.] • [PLN/pc]	
80	7	39,66	22,35
100	7	49,54	28,12
125	7	62,83	35,74
150	7	84,15	47,69
160	7	84,15	47,69
200	7	108,67	61,18
<b>Wersja z ramką SF-SF</b>			
100	7	59,53	33,78
125	7	75,40	42,85

\*) Ilość [szt./opak.] • Quantity [pcs/pack.]

\*\*) Rabatu za wielkość zamówienia nie można łączyć z innymi rabatami lub promocjami  
• Discount for quantity of pieces ordered cannot be added to any other discount





**Zawór wyciągowy  
ze stali kwasoodpornej**  
• Exhaust air valve (stainless steel)

EV-S



øD [mm]	Op <sup>1)</sup>	Cena [PLN/szt.] • Price [PLN/pc]
80	7	74,88
100	7	80,75
125	7	98,16
150	7	147,70
160	7	160,99
200	7	265,02

**Zawór nawiewny  
ze stali kwasoodpornej**  
• Supply air valve (stainless steel)

SV-S



øD [mm]	Op <sup>1)</sup>	Cena [PLN/szt.] • Price [PLN/pc]
80	7	74,88
100	7	80,75
125	7	98,16
150	7	147,70
160	7	160,99
200	7	265,02

**Zawór nawiewno-wywiewny**  
• Plastic air valve

VP



øD [mm]	Op. <sup>1)</sup>	Cena katalogowa • Basic price	Zakup > 500 szt. <sup>2)</sup> • Order > 500 pcs <sup>2)</sup>
		[PLN/szt.] • [PLN/pc]	[PLN/szt.] • [PLN/pc]
125	7	20,91	8,03
150	7	25,03	9,17
160	7	37,39	13,08
200	7	49,85	19,26

**Zawór nawiewno-wywiewny  
ze stali chromowo-niklowej**  
• Air valve VS (CrNi steel)

VS



øD [mm]	Op <sup>1)</sup>	Cena [PLN/szt.] • Price [PLN/pc]
100	7	85,80
125	7	104,24
150	7	123,09
160	7	144,20
200	7	320,54

**Zawór przeciwpożarowy • Fire valve**

MCR ZIPP

øD [mm]	Cena [PLN/szt.] • Price [PLN/pc]
100	340,00
125	365,00

øD [mm]	Cena [PLN/szt.] • Price [PLN/pc]
160	396,00
200	420,00



**Wersja RST**, sprężyna z topikiem.  
Inne wersje na zapytanie.

<sup>1)</sup> Ilość [szt./opak.] • Quantity [pcs/pack.]

<sup>2)</sup> Rabatu za wielkość zamówienia nie można łączyć z innymi rabatami lub promocjami  
• Discount for quantity of pieces ordered cannot be added to any other discount



## Anemostat okrągły z przepustnicą • Circular diffuser with damper

DS



- materiał: aluminium, stal ocynkowana
- zintegrowana przepustnica wykonana z tw. sztucznego
- malowane proszkowo na kolor biały (RAL 9016)
- lekka waga nawet przy dużym gabarycie
- do nawiewu/wywiewu ciepłego/zimnego powietrza
- odpowiedni do systemów o zmiennej ilości powietrza

- material: aluminium, galvanized steel
- integrated damper made of plastic
- powder painted white (RAL 9016)
- light weight even in case of large size
- for hot or cold air supply/exhaust
- appropriate for systems with variable air volume

Wymiar • Size [mm]	øA [mm]	øD [mm]	øH [mm]	Cena [PLN/szt.] • Price [PLN/pc]
150	257	145	225	142,66
200	309	197	275	157,69
250	357	248	325	210,12
300	418	294	388	289,12
350	474	348	444	391,30

## Anemostat sufitowy kwadratowy • Rectangular ceiling diffuser

HB40



- wykonane z tłoczonego aluminium
- malowane proszkowo na kolor biały (RAL 9010)
- nachylenie kierownic strugi 30°
- nawiew czterokierunkowy
- odpowiedni do nawiewu/wywiewu ciepłego lub zimnego powietrza
- lekka waga nawet przy dużym gabarycie

- made of pressed aluminum
- powder painted white (RAL 9016/9010)
- directional lamellas set at 30° angle
- air flow in four directions
- good for hot or cold air supply/exhaust
- light weight even large size

Wymiar • Size [mm]	Przyłącze • Connection L × H [mm]	Cena [PLN/szt.] • Price [PLN/pc]
295 × 295	145 × 145	139,15
370 × 370	220 × 220	203,32
445 × 445	295 × 295	262,24
520 × 520	370 × 370	332,79
595 × 595	445 × 445	342,37



## Anemostat sufitowy - Ceiling diffuser

DHA / DHPT

- elementy konstrukcyjne wykonane z blachy ocynkowanej
- kierownice strugi wykonane z tłoczonego aluminium
- nawiew poziomy lub pionowy - płynnie regulowane kierownice strugi powietrza
- malowane proszkowo na kolor biały (RAL 9010)
- możliwość bezpośredniego podłączenia do instalacji - nie wymaga skrzynki rozprężnej
- łatwy montaż - wymiar dostosowany do standardowego sufitu podwieszanego (DHPT)

- structural elements are made of pressed galvanized steel
- directional lamellas are made of pressed aluminum
- vertical or horizontal air flow - full adjustment of directional lamellas
- powder painted white (RAL 9010)
- possible to connect directly to the system - no plenum box required
- easy installation - dimension is adapted to a standard finished ceiling (DHPT)



Typ - Type	Wymiar - Size [mm]	øA [mm]	øB [mm]	øC [mm]	D [mm]	Cena [PLN/szt.] • Price [PLN/pc]
<b>DHA</b>	<b>160</b>	300	160	275	85	163,15
	<b>200</b>	415	200	375	103	228,66
	<b>250</b>	520	250	475	140	272,13
	<b>315</b>	640	315	630	150	570,00
<b>DHPT</b>	<b>160</b>	300	160	275	85	332,07
	<b>200</b>	415	200	375	103	345,57
	<b>250</b>	520	250	475	140	351,02



## Anemostat kasetonowy wirowy • Rectangular swirl diffuser

SW

- elementy konstrukcyjne wykonane z tłoczonej blachy stalowej ocynkowanej
- równierne rozproszanie powietrza zapewnia 36 promieniowo rozmieszczonych łopatek
- wirowy efekt wypływu powietrza zapewnia szybkie wyrównanie temperatur w pomieszczeniu
- odpowiedni do nawiewu/wywiewu ciepłego lub zimnego powietrza
- łatwy montaż - wymiar dostosowany do standardowego sufitu podwieszanego

- structural elements are made of pressed galvanized steel
- even distribution of air is ensured by 36 blades located radially
- swirl effect of air supply ensures quick temperature balance in a room
- good for hot or cold air supply/exhaust
- easy installation - dimension is adapted to standard finished ceiling



Wymiar • Size [mm]	A [mm]	B [mm]	D [mm]	øC [mm]	Cena [PLN/szt.] • Price [PLN/pc]
<b>595 × 595</b>	540	595	595	200	352,57

## Anemostat kasetonowy wirowy • Rectangular swirl diffuser

SD-B

- elementy konstrukcyjne wykonane z tłoczonej ocynkowanej blachy stalowej
- nieruchome, skośnie umocowane łopatki zapewniają równierne rozproszanie strumienia powietrza
- wirowy efekt wypływu powietrza zapewnia szybkie wyrównanie temperatur w pomieszczeniu
- odpowiedni do nawiewu zimnego i ciepłego powietrza
- łatwy montaż w suficie podwieszanym 600x600

- structural elements are made of pressed galvanized steel
- immovable, diagonal blades ensure even air stream distribution
- swirl effect of air outflow ensures quick temperature balance in a room
- good for hot or cold air supply/exhaust
- easy installation in finished ceiling 600x600



Wymiar • Size [mm]	□Q [mm]	øL [mm]	Cena [PLN/szt.] • Price [PLN/pc]
<b>300</b>	595	254	378,83
<b>400</b>	595	336	393,67
<b>500</b>	595	440	407,06
<b>600</b>	595	530	439,30
<b>625</b>	620	530	440,53







## Anemostat kasetonowy wirowy • Rectangular swirl diffuser

SD-C

- elementy konstrukcyjne wykonane z tłoczonej blachy stalowej ocynkowanej
- kierownice nawiewu wykonane z wysokiej jakości tworzywa sztucznego
- od 8 do 48 promieniowo rozmieszczonych skośnych szczelin zapewnia równomierne rozproszanie strumienia
- możliwość uzyskania do 30 wymian powietrza
- możliwość stosowania do nawiewu lub wywiewu powietrza

- structural elements are made of pressed galvanized steel
- directional lamellas are made of high quality plastic
- 8 to 48 diagonal slots located radially ensure even distribution of air
- possibility to achieve up to 30 air exchanges
- it is possible to use air exhaust or supply



SD-C 300 8 szczelin • slots	SD-C 400 16 szczelin • slots	SD-C 500 24 szczeliny • slots	SD-C 600 24 szczeliny • slots	SD-C 600 48 szczelin • slots
□300	□398	□498	□598	□598
				
Cena [PLN/szt.] • Price [PLN/pc]				
246,58	316,73	363,69	399,95	431,57

## Anemostat wirowy • Circular swirl diffuser

DVR



- wykonane z galwanizowanej blachy stalowej,
- regulowane kierownice nawiewu,
- od 16 do 32 promieniowo rozmieszczonych skośnych szczelin zapewnia równomierne rozproszanie strumienia,
- łatwy montaż, mocowanie jedną śrubą R1

- made of galvanized steel sheet,
- adjustable guide vanes,
- 16 - 32 radially placed askew slots ensure even air stream distribution,
- easy installation, with just one R1 bolt

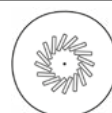
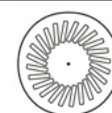
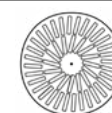
Ø400 16 szczelin • slots	Ø500 24 szczeliny • slots	Ø600 32 szczeliny • slots
		
Cena [PLN/szt.] • Price [PLN/pc]		
154,19	237,00	279,85



Anemostat sufitowy nawiewny • Rectangular ceiling diffuser								ASN	
Wielkość • Size	0	1	2	3	4	5	6	7	8
Wymiar • Dimension [mm]	190	245	301	357	412	469	498	598	623
Rodzaj • Type	Cena [PLN/szt.] • Price [PLN/pc]								
ASN	47,00	57,00	68,00	80,00	99,00	123,00	130,00	143,00	150,00
ASN-P	×	81,00	104,00	123,00	152,00	198,00	211,00	270,00	306,00

ASN-0 nawiewny wirowy • supply swirl	ASN-1 nawiewny jednostronny • one side supply	ASN-2 nawiewny dwustronny • two side supply	ASN-3 nawiewny trójstronny • three side supply	ASN-5 nawiewny narożny • corner supply
ASN × 1,5	ASN × 1,3	ASN × 1,3	ASN × 1,5	ASN × 1,5

Anemostat sufitowy wywiewny • Exhaust ceiling diffuser	ASW
--	-----



Wielkość • Size	0	1	2	3	4	5	6	7	8
Wymiar • Dimension [mm]	190	245	301	357	412	469	498	598	623
Cena [PLN/szt.] • Price [PLN/pc]	36,00	44,00	51,00	61,00	71,00	77,00	87,00	97,00	103,00

Anemostat sufitowy wywiewny z przepustnicą • Exhaust ceiling diffuser with the damper	ASW-P
--	-------



Wielkość • Size	1	2	3	4	5	6	7	8
Wymiar • Dimension [mm]	301	357	412	469	498	598	623	623
Cena [PLN/szt.] • Price [PLN/pc]	80,00	94,00	128,00	152,00	183,00	214,00	313,00	319,00

Wykonanie: blacha kwasoodporna - cena × 4 • Execution: acid-proof sheet - price × 4



## Anemostat sufitowy prostokątny • Rectangular ceiling diffuser (ASN6 ÷ ASN13) ASN

Wymiar • Size	
L [mm]	H [mm]
498	357
598	357
714	357
824	357
996	357
1196	357
1407	357
598	412
714	412
824	412
996	412
1196	412
1407	412
714	469
824	469
996	469
1196	469
1407	469
824	498
996	498
1196	498
1407	498
996	598
1196	598
1407	598
1096	598
1246	714
714	714
1407	714

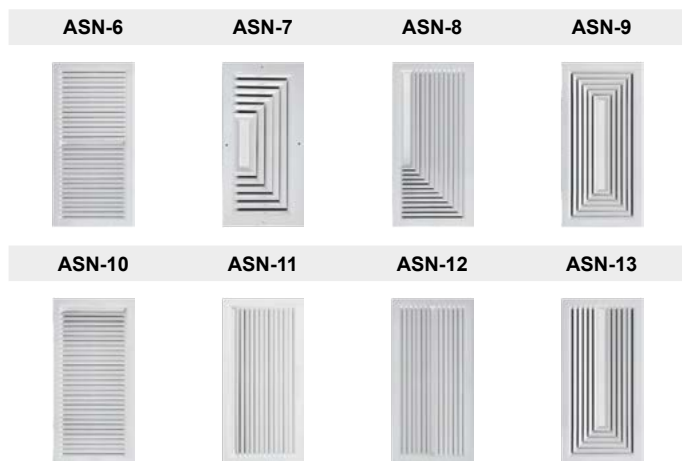

### OFERTY CENOWE NA ZAPYTANIE • PRICE FOR ENQUIRY

<b>ASN</b>	sufitowy nawiewny tylko kratka • supply ceiling diffuser the grille only
<b>ASN-P</b>	sufitowy nawiewny z przepustnicą • supply ceiling diffuser with the damper
<b>ASN-PSR</b>	sufitowy nawiewny z przepustnicą i skrzynką rozprężną • supply ceiling diffuser with the damper and plenum box
<b>ASN-PSRI</b>	sufitowy nawiewny z przepustnicą i skrzynką rozprężną izolowaną akustycznie • supply ceiling diffuser with the damper and plenum box with acoustic insulation
<b>ASN-SR</b>	sufitowy nawiewny ze skrzynką rozprężną • supply ceiling diffuser with the plenum box
<b>ASN-SRI</b>	sufitowy nawiewny ze skrzynką rozprężną izolowaną akustycznie • supply ceiling diffuser with the plenum box with acoustic insulation
<b>ASN-SRP</b>	sufitowy nawiewny ze skrzynką rozprężną i przepustnicą na wlocie • supply ceiling diffuser with the plenum box and damper at the inlet
<b>ASN-SRIP</b>	sufitowy nawiewny ze skrzynką rozprężną izolowaną akustycznie i przepustnicą na wlocie • supply ceiling diffuser with the plenum box with acoustic insulation and the damper at the inlet



## Nawiewnik szczelinowy • Slot diffuser

SDML



Model	A [mm]	B [mm]	C [mm]	B1 [mm]	F [mm]	G [mm]	H [mm]	L [mm]	Cena [PLN/szt.] • Price [PLN/pc]
<b>2 Sloty</b> • 2 slots	123	28	24	19	42	88	37	1022	406,54
<b>3 Sloty</b> • 3 slots	167	28	24	19	42	131	37	1022	527,77
<b>4 Sloty</b> • 4 slots	207	28	24	19	42	174	37	1022	591,12

## Nawiewnik podłogowy • Circular swirl floor diffuser

FDS

- okrągłe nawiewniki wirowe przeznaczone do montażu w podłodze,
- wykonane z aluminium, podstawa wykonana z blachy stalowej ocynkowanej,
- specjalna konstrukcja umożliwiająca czyszczenie nawiewnika
- circular air supply diffuser with swirl function from mounting in floors,
- diffuser manufactured in cast aluminium, drip trap and internal swirl constructed in galvanized steel,
- a cleanable diffuser



Wielkość • Size [mm]	Cena [PLN/szt.] • Price [PLN/pc]
<b>150</b>	232,37
<b>160</b>	238,55
<b>200</b>	246,48





## Dysza dalekiego zasięgu • Jet diffuser

JNS



Wielkość • Size [mm]	D1 [mm]	D2 [mm]	D3 [mm]	E [mm]	F [mm]	L1 [mm]	Cena [PLN/szt.] • Price [PLN/pc]
<b>100</b>	162	98	50	10	-2	78	352,98
<b>125</b>	185	123	64	10	4	89	450,32
<b>160</b>	216	158	82	11	10	106	572,78
<b>200</b>	273	198	108	16	14	127	651,99
<b>250</b>	318	248	136	16	23	159	817,72
<b>315</b>	400	313	174	23	29	189	1 026,70
<b>400</b>	483	398	230	24	47	223	1 303,98
<b>500</b>	596	498	286	27,5	60	290	1 634,51



## Skrzynka rozprężna • Plenum box

SR-ASN



Wielkość kratki • Grille size [mm]	Wymiar • Size AxA [mm]	Cena [PLN/szt.] • Price [PLN/pc]			
		Tylko skrzynka • Box only SR-ASN	Skrzynka z przepustnicą • Box with damper SR-ASN+P	Skrzynka z izolacją akustyczną • Box with acoustic insulation SR-ASN+I <sup>(*)</sup>	Skrzynka z przepustnicą oraz izolacją akustyczną • Box with damper and acoustic insulation SR-ASN+I+P <sup>(*)</sup>
<b>190×190</b>	<b>150×150</b>	77,25	93,22	128,75	154,50
<b>245×245</b>	<b>204×204</b>	81,89	95,48	135,75	159,14
<b>301×301</b>	<b>260×260</b>	97,75	125,04	163,87	203,63
<b>357×357</b>	<b>316×316</b>	118,14	134,11	196,63	224,64
<b>412×412</b>	<b>372×372</b>	127,31	150,07	210,64	248,13
<b>469×469</b>	<b>428×428</b>	147,81	161,40	245,76	266,77
<b>498×498</b>	<b>457×457</b>	159,14	177,37	264,40	292,62
<b>598×598</b>	<b>557×557</b>	184,16	200,03	304,26	330,01
<b>623×623</b>	<b>582×582</b>	200,03	222,79	332,38	367,50

## Skrzynka rozprężna • Plenum box

SR-HB40

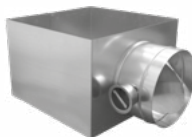

Wielkość anemostatu • Diffuser size [mm]	Wymiar • Size AxA [mm]	Cena [PLN/szt.] • Price [PLN/pc]			
		Tylko skrzynka • Box only SR-HB40	Skrzynka z przepustnicą • Box with damper SR-HB40+P	Skrzynka z izolacją akustyczną • Box with acoustic insulation SR-HB40+I <sup>(*)</sup>	Skrzynka z przepustnicą oraz izolacją akustyczną • Box with damper and acoustic insulation SR-HB40+I+P <sup>(*)</sup>
<b>295×295</b>	<b>153×153</b>	77,25	93,22	128,75	154,50
<b>370×370</b>	<b>232×232</b>	81,89	95,48	135,75	159,14
<b>445×445</b>	<b>308×308</b>	97,75	125,04	163,87	203,63
<b>520×520</b>	<b>384×384</b>	118,14	134,11	196,63	224,64
<b>595×595</b>	<b>455×455</b>	127,31	150,07	210,64	248,13

<sup>(\*)</sup> Izolacja: mata termoizolacyjna samoprzylepna MST • Insulation: thermal insulation adhesive mat MST



## Skrzynka rozprężna • Plenum box

SR-SD-B

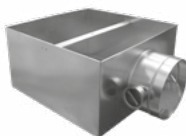

Typ anemostatu • Diffuser type [mm]	Wymiar • Size AxA [mm]	Cena [PLN/szt.] • Price [PLN/pc]			
		Tylko skrzynka • Box only SR-SD-B	Skrzynka z przepustnicą • Box with damper SR-SD-B+P	Skrzynka z izolacją akustyczną • Box with acoustic insulation SR-SD-B+I <sup>(*)</sup>	Skrzynka z przepustnicą oraz izolacją akustyczną • Box with damper and acoustic insulation SR-SD-B+I+P <sup>(*)</sup>
<b>SD-B 300</b>	<b>580x580</b>	181,80	208,99	299,94	354,42
<b>SD-B 400</b>					
<b>SD-B 500</b>					
<b>SD-B 600</b>					
<b>SD-B 625</b>					

## Skrzynka rozprężna • Plenum box

SR-SD-C

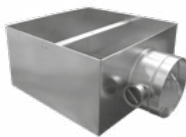

Typ anemostatu • Diffuser type [mm]	Wymiar • Size AxA [mm]	Cena [PLN/szt.] • Price [PLN/pc]			
		Tylko skrzynka • Box only SR-SD-C	Skrzynka z przepustnicą • Box with damper SR-SD-C+P	Skrzynka z izolacją akustyczną • Box with acoustic insulation SR-SD-C+I <sup>(*)</sup>	Skrzynka z przepustnicą oraz izolacją akustyczną • Box with damper and acoustic insulation SR-SD-C+I+P <sup>(*)</sup>
<b>SD-C 300</b>	<b>285x285</b>	90,02	103,52	148,53	175,51
<b>SD-C 400</b>	<b>367x367</b>	126,90	145,95	209,30	247,41
<b>SD-C 500</b>	<b>455x455</b>	156,56	180,04	258,32	305,29
<b>SD-C 600</b>	<b>580x580</b>	181,80	208,99	299,94	354,42

<sup>(\*)</sup> Izolacja: mata termoizolacyjna samoprzylepna MST • Insulation: thermal insulation adhesive mat MST



## Skrzynka rozprężna • Plenum box

SR-DVR

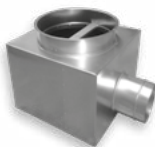

Wymiar anemostatu • Diffuser size [mm]	Wymiar • Size A×A [mm]	Cena [PLN/szt.] • Price [PLN/pc]			
		Tylko skrzynka • Box only SR-DVR	Skrzynka z przepustnicą • Box with damper SR-DVR+P	Skrzynka z izolacją akustyczną • Box with acoustic insulation SR-DVR+I <sup>(*)</sup>	Skrzynka z przepustnicą oraz izolacją akustyczną • Box with damper and acoustic insulation SR-DVR+I+P <sup>(*)</sup>
<b>400×16</b>	<b>450×450</b>	172,22	198,07	278,92	326,61
<b>500×24</b>	<b>550×550</b>	196,32	225,78	323,94	377,50
<b>600×32</b>	<b>650×650</b>	220,01	245,04	365,65	404,28

## Skrzynka rozprężna • Plenum box

SR-SW

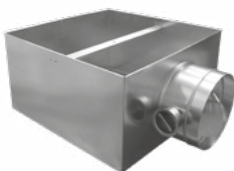

Wymiar anemostatu • Diffuser size [mm]	Wymiar • Size A×A [mm]	Cena [PLN/szt.] • Price [PLN/pc]			
		Tylko skrzynka • Box only SR-SW	Skrzynka z przepustnicą • Box with damper SR-SW+P	Skrzynka z izolacją akustyczną • Box with acoustic insulation SR-SW+I <sup>(*)</sup>	Skrzynka z przepustnicą oraz izolacją akustyczną • Box with damper and acoustic insulation SR-SW+I+P <sup>(*)</sup>
<b>595×595</b>	<b>580×580</b>	181,80	208,99	299,94	354,42

<sup>(\*)</sup> Izolacja: mata termoizolacyjna samoprzylepna MST • Insulation: thermal insulation adhesive mat MST



## Skrzynka rozprężna • Plenum box

SR-SDML



Typ anemostatu • Diffuser type [mm]	Cena [PLN/szt.] • Price [PLN/pc]			
	Tylko skrzynka • Box only SR-SDML	Skrzynka z przepustnicą • Box with damper SR-SDML+P	Skrzynka z izolacją akustyczną • Box with acoustic insulation SR-SDML+I(*)	Skrzynka z przepustnicą oraz izolacją akustyczną • Box with damper and acoustic insulation SR-SDML+I+P(*)
<b>2 szczeliny</b> • slots	181,49	208,99	299,94	354,42
<b>3 szczeliny</b> • slots	190,55	219,49	314,87	372,14
<b>4 szczeliny</b> • slots	200,13	230,41	330,63	390,68

## Skrzynka rozprężna • Plenum box

SR-EG-C



Wymiar kratki • Grille size [mm]	Wymiar • Size AxA [mm]	Cena [PLN/szt.] • Price [PLN/pc]			
		Tylko skrzynka • Box only SR-EG-C	Skrzynka z przepustnicą • Box with damper SR-EG-C+P	Skrzynka z izolacją akustyczną • Box with acoustic insulation SR-EG-C+I(*)	Skrzynka z przepustnicą oraz izolacją akustyczną • Box with damper and acoustic insulation SR-EG-C+I+P(*)
<b>595x595</b>	<b>565x565</b>	171,50	188,70	284,38	311,27

(\*) Izolacja: mata termoizolacyjna samoprzylepna MST • Insulation: thermal insulation adhesive mat MST



## Przylączy montażowe okrągłe • Circular diffuser connection

DSP



Wielkość anemostatu • Diffuser size DS [mm]	Wymiar przyłącza • Dimension connection D [mm]	Wysokość przyłącza • Height of connector H <sub>1</sub> [mm]	Wymiar podstawy • Dimension basic A [mm]	Cena [PLN/szt.] • Price [PLN/pc]
160	159	140	257	44,60
200	199	140	307	50,47
250	249	140	357	60,77
300	314	140	407	65,30
350	349	140	457	68,29

## Kratka ścienna aluminiowa • Aluminium wall grille

KSH-P-AL



L [mm]	160	200	250	315	400	500
H [mm]	Cena [PLN/szt.] • Price [PLN/pc]					
160	103,41	122,06	133,49	150,17	177,88	215,99
200	x	129,68	145,54	164,39	194,88	235,97
250	x	x	160,99	182,31	217,02	264,71
315	x	x	x	205,18	245,14	299,94
400	x	x	x	x	282,32	346,49
500	x	x	x	x	x	400,36

## Kratka wyciągowa aluminiowa • Exhaust grille

EG-C



H [mm]	H1 [mm]	Cena [PLN/szt.] • Price [PLN/pc]
595	595	214,45



## Kratka na kanały okrągłe ocynkowowana - Grille for round ducts

SGD



H [mm]	75	125	175	225
L [mm]	Cena [PLN/szt.] • Price [PLN/pc]			
425	67,77	89,82	x	124,84
525	102,07	108,36	118,76	x
625	x	x	x	175,72

## Przepustnica na kratkę SGD - Damper for grille SGD

PSGD



H [mm]	75	125	225
L [mm]	Cena [PLN/szt.] • Price [PLN/pc]		
425	77,15	88,89	113,71
525	90,43	105,58	x
625	x	x	155,32

## Kratki wentylacyjne RENSON



Creating healthy spaces

Kratki wentylacyjne firmy RENSON to estetyczny i trwały pomysł na efektywną wentylację. Wszystkie kratki firmy RENSON wykonane są z aluminiowych, ekstrudowanych profili. Dostarczane są jako gotowe do montażu lub w systemie do samodzielnego wykonania. Posiadamy bogatą gamę zewnętrznych i wewnętrznych krat: ściennie do zabudowy, okienne, przeciwpożarowe, podłogowe, dźwiękochłonne i drzwiowe. Dostępne są w różnych rozmiarach i kształtach. Produkty mogą być przygotowane w kolorze naturalnego lub epoksydowanego aluminium, oraz malowane proszkowo w każdym z ponad 150 kolorów z palety RAL. Wszystkie kratki posiadają certyfikat HEVAC - na odporność na przenikanie wody.



## Kratki wentylacyjne:

- ściennie
- okienne
- naściennie
- dźwiękochłonne
- wewnętrzne



## Kratka wentylacyjna ścienna z kierownicami poziomymi

• Grille with horizontal blades

KSH



L [mm]	125	225	325	425	525	625	825	1025	1225
H [mm]	Cena [PLN/szt.] • Price [PLN/pc]								
75	31,00	36,00	40,00	44,00	48,00	61,00	74,00	94,00	114,00
125	38,00	41,00	45,00	49,00	55,00	70,00	85,00	106,00	129,00
225	×	49,00	55,00	60,00	66,00	87,00	104,00	130,00	156,00
325	×	×	64,00	70,00	79,00	103,00	123,00	152,00	186,00
425	×	×	×	85,00	94,00	123,00	146,00	186,00	219,00
525	×	×	×	×	113,00	146,00	178,00	219,00	263,00
625	×	×	×	×	×	187,00	211,00	263,00	315,00

## Kratka wentylacyjna ścienna z kierownicami poziomymi i przepustnicą

• Grille with horizontal blades and damper

KSH-P



L [mm]	125	225	325	425	525	625	825	1025	1225
H [mm]	Cena [PLN/szt.] • Price [PLN/pc]								
75	55,00	64,00	77,00	90,00	105,00	139,00	170,00	218,00	277,00
125	64,00	73,00	86,00	97,00	116,00	154,00	189,00	241,00	297,00
225	×	87,00	102,00	120,00	141,00	190,00	232,00	297,00	364,00
325	×	×	121,00	143,00	166,00	229,00	282,00	360,00	420,00
425	×	×	×	172,00	208,00	282,00	345,00	420,00	500,00
525	×	×	×	×	251,00	345,00	412,00	500,00	585,00
625	×	×	×	×	×	421,00	492,00	585,00	705,00

Wykonanie: blacha kwasoodporna - cena × 4 • Execution: acid resistant sheet - price × 4

Malowanie na kolor niestandardowy +20% • Painting in not standard color +20%

Wymiary otworu montażowego L/H • Size of the assembly opening L/H

Inne wymiary na zapytanie • Other dimensions for enquiry





## Kratka wentylacyjna ścienna z dwoma rzędami kierownic

• Grille with double-row blades

KSH-V



L [mm]	125	225	325	425	525	625	825	1025	1225
H [mm]	Cena [PLN/szt.] • Price [PLN/pc]								
75	45,00	48,00	54,00	62,00	69,00	90,00	112,00	136,00	170,00
125	50,00	55,00	60,00	69,00	85,00	105,00	130,00	170,00	204,00
225	×	66,00	74,00	85,00	102,00	123,00	163,00	204,00	248,00
325	×	×	86,00	102,00	119,00	156,00	197,00	248,00	295,00
425	×	×	×	119,00	146,00	188,00	236,00	295,00	355,00
525	×	×	×	×	174,00	225,00	284,00	355,00	423,00
625	×	×	×	×	×	270,00	339,00	423,00	510,00

## Kratka wentylacyjna ścienna z dwoma rzędami kierownic i przepustnicą

• Grille with double-row blades and damper

KSH-VP



L [mm]	125	225	325	425	525	625	825	1025	1225
H [mm]	Cena [PLN/szt.] • Price [PLN/pc]								
75	69,00	77,00	92,00	108,00	126,00	168,00	208,00	260,00	333,00
125	76,00	87,00	101,00	116,00	147,00	189,00	234,00	305,00	372,00
225	×	104,00	122,00	146,00	177,00	226,00	291,00	371,00	456,00
325	×	×	138,00	159,00	191,00	243,00	356,00	456,00	529,00
425	×	×	×	206,00	260,00	347,00	435,00	529,00	635,00
525	×	×	×	×	312,00	423,00	509,00	635,00	746,00
625	×	×	×	×	×	504,00	620,00	746,00	900,00

Wykonanie: blacha kwasoodporna - cena × 4 • Execution: acid resistant sheet - price × 4

Malowanie na kolor niestandardowy +20% • Painting in not standard color +20%

Wymiary otworu montażowego L/H • Size of the assembly opening L/H

Inne wymiary na zapytanie • Other dimensions for enquiry



## Kratka wentylacyjna ścienna z kierownicami pionowymi

• Grille with vertical blades

KSV



L [mm]	125	225	325	425	525	625	825	1025	1225
H [mm]	Cena [PLN/szt.] • Price [PLN/pc]								
75	36,00	40,00	44,00	48,00	52,00	69,00	84,00	104,00	127,00
125	38,00	45,00	49,00	55,00	60,00	82,00	95,00	118,00	142,00
225	×	49,00	60,00	66,00	72,00	97,00	114,00	144,00	171,00
325	×	×	64,00	79,00	86,00	113,00	134,00	167,00	204,00
425	×	×	×	85,00	104,00	134,00	162,00	204,00	242,00
525	×	×	×	×	113,00	162,00	194,00	242,00	290,00
625	×	×	×	×	×	187,00	234,00	291,00	348,00

## Kratka wentylacyjna ścienna z kierownicami pionowymi i przepustnicą

• Grille with vertical blades and damper

KSV-P



L [mm]	125	225	325	425	525	625	825	1025	1225
H [mm]	Cena [PLN/szt.] • Price [PLN/pc]								
75	60,00	68,00	81,00	94,00	109,00	147,00	180,00	228,00	290,00
125	64,00	77,00	90,00	103,00	121,00	166,00	199,00	253,00	310,00
225	×	87,00	107,00	126,00	147,00	200,00	242,00	311,00	379,00
325	×	×	121,00	152,00	173,00	239,00	293,00	375,00	438,00
425	×	×	×	172,00	218,00	293,00	361,00	438,00	523,00
525	×	×	×	×	251,00	361,00	428,00	523,00	612,00
625	×	×	×	×	×	421,00	515,00	613,00	738,00

Wykonanie: blacha kwasoodporna - cena × 4 • Execution: acid resistant sheet - price × 4

Malowanie na kolor niestandardowy +20% • Painting in not standard color +20%

Wymiary otworu montażowego L/H • Size of the assembly opening L/H

Inne wymiary na zapytanie • Other dimensions for enquiry



## Kratka wentylacyjna ścienna z dwoma rzędami kierownic

• Grille with double-row blades

KSV-H



L [mm]	125	225	325	425	525	625	825	1025	1225
H [mm]	Cena [PLN/szt.] • Price [PLN/pc]								
75	45,00	48,00	54,00	62,00	69,00	90,00	112,00	136,00	170,00
125	50,00	55,00	60,00	69,00	85,00	105,00	130,00	170,00	204,00
225	×	66,00	74,00	85,00	102,00	123,00	163,00	204,00	248,00
325	×	×	86,00	102,00	119,00	156,00	197,00	248,00	295,00
425	×	×	×	119,00	146,00	188,00	236,00	295,00	355,00
525	×	×	×	×	174,00	225,00	284,00	355,00	423,00
625	×	×	×	×	×	270,00	339,00	423,00	510,00

## Kratka wentylacyjna ścienna z dwoma rzędami kierownic i przepustnicą

• Grille with double-row blades and damper

KSV-HP



L [mm]	125	225	325	425	525	625	825	1025	1225
H [mm]	Cena [PLN/szt.] • Price [PLN/pc]								
75	69,00	77,00	92,00	108,00	126,00	168,00	208,00	260,00	333,00
125	76,00	87,00	101,00	116,00	147,00	189,00	234,00	305,00	372,00
225	×	104,00	122,00	146,00	177,00	226,00	291,00	371,00	456,00
325	×	×	138,00	159,00	191,00	243,00	356,00	456,00	529,00
425	×	×	×	206,00	260,00	347,00	435,00	529,00	635,00
525	×	×	×	×	312,00	423,00	509,00	635,00	746,00
625	×	×	×	×	×	504,00	620,00	746,00	900,00

Wykonanie: blacha kwasoodporna - cena × 4 • Execution: acid resistant sheet - price × 4

Malowanie na kolor niestandardowy +20% • Painting in not standard color +20%

Wymiary otworu montażowego L/H • Size of the assembly opening L/H

Inne wymiary na zapytanie • Other dimensions for enquiry

**Kratka wentylacyjna ścienna z kierownicami poziomymi i przepustnicą jednoelementową**
*• Grille with double-row blades*
**KSH-N**

L [mm]	125	225	325	425	525	625	825	1025	1225
H [mm]	Cena [PLN/szt.] • Price [PLN/pc]								
75	46,00	53,00	61,00	70,00	80,00	107,00	127,00	165,00	202,00
125	55,00	59,00	69,00	79,00	89,00	118,00	145,00	183,00	227,00
225	x	72,00	82,00	94,00	112,00	147,00	178,00	222,00	267,00
325	x	x	97,00	112,00	130,00	175,00	211,00	264,00	319,00
425	x	x	x	136,00	162,00	211,00	254,00	319,00	380,00
525	x	x	x	x	198,00	254,00	306,00	380,00	443,00
625	x	x	x	x	x	314,00	365,00	443,00	531,00

**Kratka wentylacyjna ścienna z dwoma rzędami kierownic i z przepustnicą jednoelementową**
*• Grille with double-row blades and deflector flap damper*
**KSH-VN**

L [mm]	125	225	325	425	525	625	825	1025	1225
H [mm]	Cena [PLN/szt.] • Price [PLN/pc]								
75	59,00	64,00	76,00	88,00	101,00	136,00	165,00	208,00	257,00
125	67,00	74,00	84,00	99,00	120,00	153,00	189,00	246,00	302,00
225	x	88,00	101,00	119,00	149,00	182,00	237,00	295,00	361,00
325	x	x	119,00	145,00	170,00	228,00	285,00	360,00	428,00
425	x	x	x	170,00	214,00	277,00	344,00	428,00	515,00
525	x	x	x	x	258,00	333,00	412,00	515,00	603,00
625	x	x	x	x	x	397,00	493,00	603,00	726,00

Wykonanie: blacha kwasoodporna - cena × 4 • Execution: acid resistant sheet - price × 4

Malowanie na kolor niestandardowy +20% • Painting in not standard color +20%

Wymiary otworu montażowego L/H • Size of the assembly opening L/H

Inne wymiary na zapytanie • Other dimensions for enquiry

**Kratka wentylacyjna ścienna z kierownicami pionowymi i przepustnicą jednoelementową**
*• Grille with vertical blades and deflector flap damper*
**KSV-N**

L [mm]	125	225	325	425	525	625	825	1025	1225
H [mm]	Cena [PLN/szt.] • Price [PLN/pc]								
75	51,00	56,00	66,00	74,00	84,00	114,00	137,00	176,00	214,00
125	55,00	63,00	73,00	85,00	95,00	130,00	154,00	194,00	240,00
225	×	72,00	87,00	99,00	119,00	156,00	188,00	235,00	282,00
325	×	×	97,00	122,00	137,00	185,00	223,00	280,00	337,00
425	×	×	×	136,00	173,00	223,00	270,00	337,00	402,00
525	×	×	×	×	198,00	270,00	322,00	402,00	470,00
625	×	×	×	×	×	314,00	388,00	471,00	565,00

**Kratka wentylacyjna ścienna z dwoma rzędami kierownic i z przepustnicą jednoelementową**
*• Grille with double-row blades and deflector flap damper*
**KSV-HN**

L [mm]	125	225	325	425	525	625	825	1025	1225
H [mm]	Cena [PLN/szt.] • Price [PLN/pc]								
75	59,00	64,00	76,00	88,00	101,00	136,00	165,00	208,00	257,00
125	67,00	74,00	84,00	99,00	120,00	153,00	189,00	246,00	302,00
225	×	88,00	101,00	119,00	149,00	182,00	237,00	295,00	361,00
325	×	×	119,00	145,00	170,00	228,00	285,00	360,00	428,00
425	×	×	×	170,00	214,00	277,00	344,00	428,00	515,00
525	×	×	×	×	258,00	333,00	412,00	515,00	603,00
625	×	×	×	×	×	397,00	493,00	603,00	726,00

Wykonanie: blacha kwasoodporna - cena × 4 • Execution: acid resistant sheet - price × 4

Wymiary otworu montażowego L/H • Size of the assembly opening L/H

Inne wymiary na zapytanie • Other dimensions for enquiry



## Kratka ścienna - Wall grille

KWP



L [mm]	125	225	325	425	525	625	825	1025	1225
H [mm]	Cena [PLN/szt.] • Price [PLN/pc]								
75	37,00	41,00	46,00	51,00	57,00	70,00	89,00	113,00	134,00
125	44,00	48,00	55,00	58,00	63,00	82,00	100,00	126,00	152,00
225	56,00	58,00	63,00	70,00	80,00	98,00	123,00	154,00	182,00
325	61,00	73,00	75,00	84,00	93,00	118,00	146,00	180,00	218,00
425	67,00	81,00	96,00	99,00	111,00	141,00	171,00	218,00	258,00
525	73,00	94,00	106,00	128,00	132,00	166,00	208,00	258,00	313,00
625	94,00	119,00	134,00	162,00	191,00	202,00	249,00	313,00	372,00
825	113,00	135,00	162,00	191,00	233,00	278,00	342,00	412,00	494,00
1025	142,00	171,00	200,00	243,00	288,00	350,00	431,00	519,00	622,00
1225	171,00	202,00	243,00	288,00	350,00	415,00	512,00	615,00	739,00

Wykonanie: blacha kwasoodporna - cena × 4 • Execution: acid resistant sheet - price × 4

Wymiary otworu montażowego L/H • Size of the assembly opening L/H

Inne wymiary na zapytanie • Other dimensions for enquiry



## Maskownica • Frame

M



L [mm]	125	225	325	425	525	625	825	1025	1225
H [mm]	Cena [PLN/szt.] • Price [PLN/pc]								
75	16,00	17,00	20,00	21,00	23,00	27,00	36,00	45,00	54,00
125	19,00	20,00	22,00	23,00	25,00	33,00	40,00	51,00	60,00
225	×	23,00	25,00	27,00	31,00	40,00	50,00	61,00	72,00
325	×	×	30,00	34,00	37,00	48,00	58,00	72,00	87,00
425	×	×	×	40,00	45,00	57,00	69,00	87,00	102,00
525	×	×	×	×	52,00	67,00	84,00	102,00	125,00
625	×	×	×	×	×	82,00	99,00	125,00	150,00
825	×	×	×	×	×	×	136,00	165,00	198,00
1025	×	×	×	×	×	×	×	207,00	251,00
1225	×	×	×	×	×	×	×	×	295,00

## Kratka z siatką • Grille with mesh

KWS



L [mm]	125	225	325	425	525	625	825	1025	1225
H [mm]	Cena [PLN/szt.] • Price [PLN/pc]								
75	27,00	30,00	33,00	40,00	45,00	52,00	72,00	112,00	141,00
125	30,00	33,00	43,00	48,00	56,00	62,00	87,00	122,00	157,00
225	×	43,00	48,00	56,00	62,00	70,00	100,00	141,00	170,00
325	×	×	56,00	62,00	70,00	85,00	122,00	157,00	192,00
425	×	×	×	70,00	85,00	97,00	141,00	170,00	214,00
525	×	×	×	×	97,00	118,00	157,00	193,00	234,00
625	×	×	×	×	×	137,00	170,00	214,00	255,00

Malowanie na kolor standardowy + 10%, niestandardowy +25% • Painting in standard color + 10%, not standard + 25%

Wymiary otworu montażowego L/H • Size of the assembly opening L/H

Inne wymiary na zapytanie • Other dimensions for enquiry



## Kratka podłogowa • Floor grille

KNP



L [mm]	125	225	325	425	525	625	825	1025	1225
H [mm]	Cena [PLN/szt.] • Price [PLN/pc]								
125	164,00	180,00	197,00	217,00	252,00	300,00	370,00	465,00	560,00
225	×	216,00	237,00	262,00	288,00	361,00	445,00	558,00	670,00
325	×	×	285,00	373,00	272,00	473,00	583,00	731,00	879,00

Kratka wentylacyjna z nieruchomymi kierownicami o nachyleniu 45° lub 90°  
• Grille with fixed blades on a tilt of 45° or 90°KSH-45  
KSH-90

L [mm]	125	225	325	425	525	625	825	1025	1225
H [mm]	Cena [PLN/szt.] • Price [PLN/pc]								
75	32,00	36,00	40,00	44,00	50,00	62,00	78,00	98,00	121,00
125	38,00	41,00	45,00	50,00	56,00	72,00	89,00	111,00	135,00
225	45,00	50,00	56,00	61,00	68,00	89,00	108,00	136,00	163,00
325	51,00	61,00	66,00	71,00	82,00	104,00	128,00	158,00	194,00
425	56,00	68,00	82,00	87,00	95,00	125,00	153,00	194,00	229,00
525	61,00	73,00	88,00	105,00	115,00	148,00	186,00	229,00	277,00
625	84,00	100,00	115,00	136,00	165,00	190,00	222,00	277,00	333,00
825	97,00	116,00	136,00	164,00	198,00	238,00	306,00	366,00	437,00
1025	121,00	147,00	173,00	209,00	248,00	297,00	363,00	437,00	525,00
1225	146,00	174,00	209,00	248,00	296,00	355,00	437,00	525,00	630,00

Wykonanie: blacha kwasoodporna - cena × 4 • Execution: acid resistant sheet - price × 4

Wymiary otworu montażowego L/H • Size of the assembly opening L/H

Inne wymiary na zapytanie • Other dimensions for enquiry





## Kratka wentylacyjna osłonowa maskująca - Masking grille

KST



L [mm]	75	125	225	325	425	525	625	825	1025	1225
H [mm]	Cena [PLN/szt.] - Price [PLN/pc]									
75	×	36,00	40,00	45,00	50,00	57,00	69,00	87,00	106,00	130,00
125	40,00	42,00	47,00	52,00	58,00	61,00	75,00	97,00	123,00	286,00
225	49,00	54,00	58,00	61,00	69,00	74,00	97,00	119,00	146,00	175,00
325	53,00	58,00	69,00	73,00	83,00	90,00	114,00	138,00	171,00	209,00
425	60,00	61,00	76,00	87,00	97,00	108,00	134,00	165,00	209,00	249,00
525	66,00	69,00	85,00	99,00	119,00	129,00	160,00	199,00	249,00	301,00
625	78,00	86,00	105,00	124,00	149,00	178,00	192,00	238,00	301,00	358,00
825	90,00	102,00	125,00	149,00	178,00	215,00	255,00	317,00	393,00	472,00
1025	113,00	129,00	160,00	186,00	223,00	266,00	320,00	393,00	472,00	565,00
1225	133,00	154,00	194,00	223,00	266,00	320,00	381,00	472,00	565,00	680,00

Kratka wentylacyjna osłonowa maskująca z przepustnicą jednopłaszczyznową  
- Masking grille with single-leaf damper

KST-P



L [mm]	75	125	225	325	425	525	625	825	1025	1225
H [mm]	Cena [PLN/szt.] - Price [PLN/pc]									
75	×	60,00	68,00	82,00	96,00	114,00	147,00	183,00	230,00	293,00
125	64,00	68,00	79,00	93,00	106,00	122,00	159,00	201,00	258,00	454,00
225	75,00	88,00	96,00	108,00	129,00	149,00	200,00	247,00	313,00	383,00
325	87,00	104,00	121,00	130,00	156,00	177,00	240,00	297,00	379,00	443,00
425	106,00	114,00	143,00	167,00	184,00	222,00	293,00	364,00	443,00	530,00
525	119,00	137,00	167,00	196,00	245,00	267,00	359,00	433,00	530,00	623,00
625	146,00	179,00	218,00	262,00	326,00	396,00	426,00	519,00	623,00	748,00
825	183,00	216,00	266,00	326,00	396,00	472,00	564,00	707,00	841,00	989,00
1025	227,00	278,00	343,00	415,00	480,00	575,00	675,00	886,00	1 065,00	1 247,00
1225	282,00	338,00	423,00	480,00	575,00	675,00	811,00	1 015,00	1 315,00	1 495,00

Wykonanie: blacha kwasoodporna - cena × 4 - Execution: acid resistant sheet - price × 4

Wymiary otworu montażowego L/H - Size of the assembly opening L/H

Inne wymiary na zapytanie - Other dimensions for enquiry



## Kratka wentylacyjna na kanał zwijany z kierownicami poziomymi

• Grille for circular ducts with horizontal blades

KSH-1



L [mm]	125	225	325	425	525	625	825	1025	1225
H [mm]	Cena [PLN/szt.] • Price [PLN/pc]								
75	48,00	52,00	56,00	63,00	70,00	93,00	111,00	144,00	172,00
125	60,00	58,00	64,00	71,00	77,00	105,00	127,00	162,00	192,00
225	×	71,00	77,00	89,00	96,00	129,00	156,00	198,00	233,00
325	×	×	94,00	103,00	114,00	149,00	179,00	231,00	276,00
425	×	×	×	122,00	136,00	179,00	216,00	276,00	332,00
525	×	×	×	×	162,00	216,00	258,00	332,00	397,00
625	×	×	×	×	×	273,00	309,00	397,00	475,00

## Kratka wentylacyjna na kanał zwijany z kierownicami poziomymi

• Grille for circular ducts with horizontal blades

KSH-2

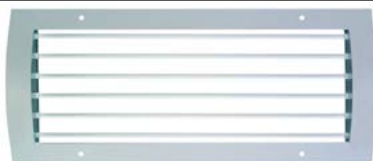

L [mm]	125	225	325	425	525	625	825	1025	1225
H [mm]	Cena [PLN/szt.] • Price [PLN/pc]								
75	42,00	45,00	52,00	56,00	63,00	79,00	99,00	126,00	148,00
125	48,00	54,00	57,00	65,00	70,00	85,00	111,00	139,00	166,00
225	×	65,00	70,00	78,00	86,00	113,00	135,00	171,00	202,00
325	×	×	84,00	94,00	103,00	132,00	158,00	201,00	240,00
425	×	×	×	111,00	122,00	158,00	191,00	240,00	285,00
525	×	×	×	×	145,00	191,00	229,00	285,00	346,00
625	×	×	×	×	×	242,00	272,00	346,00	410,00

Wykonanie: blacha kwasoodporna - cena × 4 • Execution: acid resistant sheet - price × 4

Malowanie na kolor niestandardowy +20% • Painting in not standard color +20%

Wymiary otworu montażowego L/H • Size of the assembly opening L/H

Inne wymiary na zapytanie • Other dimensions for enquiry

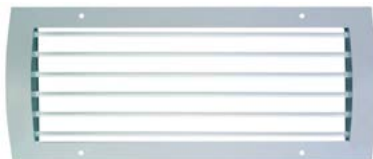
**Kratka wentylacyjna na kanał zwijany z kierownicami poziomymi i przepustnicą jednoelementową**
*• Grille for circular ducts with horizontal blades and single-leaf damper*
**KSH-P-1**

L [mm]	125	225	325	425	525	625	825	1025	1225
H [mm]	Cena [PLN/szt.] • Price [PLN/pc]								
75	72,00	80,00	93,00	109,00	127,00	171,00	207,00	268,00	335,00
125	86,00	90,00	105,00	119,00	138,00	189,00	231,00	297,00	360,00
225	x	109,00	124,00	149,00	171,00	232,00	284,00	365,00	441,00
325	x	x	151,00	176,00	201,00	275,00	338,00	439,00	510,00
425	x	x	x	209,00	250,00	338,00	415,00	510,00	613,00
525	x	x	x	x	300,00	415,00	492,00	613,00	719,00
625	x	x	x	x	x	507,00	590,00	719,00	865,00

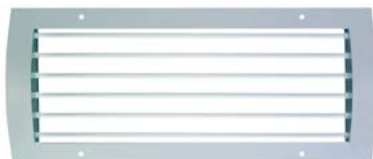
**Kratka wentylacyjna na kanał zwijany z kierownicami poziomymi i przepustnicą jednoelementową**
*• Grille for circular ducts with horizontal blades and single-leaf damper*
**KSH-P-2**

L [mm]	125	225	325	425	525	625	825	1025	1225
H [mm]	Cena [PLN/szt.] • Price [PLN/pc]								
75	66,00	73,00	89,00	102,00	120,00	157,00	195,00	250,00	311,00
125	74,00	86,00	98,00	113,00	131,00	169,00	215,00	274,00	334,00
225	x	103,00	117,00	138,00	161,00	216,00	263,00	338,00	410,00
325	x	x	141,00	167,00	190,00	258,00	317,00	409,00	474,00
425	x	x	x	198,00	236,00	317,00	390,00	474,00	566,00
525	x	x	x	x	283,00	390,00	463,00	566,00	668,00
625	x	x	x	x	x	476,00	553,00	668,00	800,00

Wykonanie: blacha kwasoodporna - cena × 4 • Execution: acid resistant sheet - price × 4

Malowanie na kolor niestandardowy +20% • Painting in not standard color +20%

Wymiary otworu montażowego L/H • Size of the assembly opening L/H

Inne wymiary na zapytanie • Other dimensions for enquiry



## Kratka wentylacyjna na kanał zwijany z kierownicami pionowymi

• Grille for circular ducts with vertical blades

KSV-1



L [mm]	125	225	325	425	525	625	825	1025	1225
H [mm]	Cena [PLN/szt.] • Price [PLN/pc]								
75	52,00	57,00	63,00	70,00	76,00	102,00	126,00	158,00	190,00
125	55,00	64,00	71,00	77,00	89,00	114,00	139,00	177,00	210,00
225	×	71,00	89,00	96,00	104,00	140,00	166,00	213,00	252,00
325	×	×	94,00	108,00	125,00	165,00	198,00	253,00	307,00
425	×	×	×	122,00	150,00	198,00	235,00	307,00	362,00
525	×	×	×	×	162,00	235,00	288,00	362,00	438,00
625	×	×	×	×	×	273,00	338,00	438,00	524,00

## Kratka wentylacyjna na kanał zwijany z kierownicami pionowymi

• Grille for circular ducts with vertical blades

KSV-2



L [mm]	125	225	325	425	525	625	825	1025	1225
H [mm]	Cena [PLN/szt.] • Price [PLN/pc]								
75	45,00	53,00	56,00	63,00	69,00	90,00	110,00	136,00	165,00
125	48,00	57,00	65,00	70,00	78,00	103,00	122,00	154,00	184,00
225	×	65,00	78,00	86,00	96,00	123,00	146,00	185,00	217,00
325	×	×	84,00	99,00	112,00	145,00	175,00	218,00	267,00
425	×	×	×	111,00	133,00	175,00	208,00	267,00	315,00
525	×	×	×	×	145,00	208,00	253,00	315,00	380,00
625	×	×	×	×	×	242,00	298,00	380,00	454,00

Wykonanie: blacha kwasoodporna - cena × 4 • Execution: acid resistant sheet - price × 4

Malowanie na kolor niestandardowy +20% • Painting in not standard color +20%

Wymiary otworu montażowego L/H • Size of the assembly opening L/H

Inne wymiary na zapytanie • Other dimensions for enquiry

**Kratka wentylacyjna na kanał zwijany z kierownicami pionowymi i przepustnicą jednoelementową**
*• Grille for circular ducts with vertical blades and single-leaf damper*

KSV-P-1



L [mm]	125	225	325	425	525	625	825	1025	1225
H [mm]	Cena [PLN/szt.] • Price [PLN/pc]								
75	76,00	85,00	100,00	116,00	133,00	180,00	222,00	282,00	353,00
125	81,00	96,00	112,00	125,00	150,00	198,00	243,00	312,00	378,00
225	×	109,00	136,00	156,00	179,00	243,00	294,00	380,00	460,00
325	×	×	151,00	181,00	212,00	291,00	357,00	461,00	541,00
425	×	×	×	209,00	264,00	357,00	434,00	541,00	643,00
525	×	×	×	×	300,00	434,00	522,00	643,00	760,00
625	×	×	×	×	×	507,00	619,00	760,00	914,00

**Kratka wentylacyjna na kanał zwijany z kierownicami pionowymi i przepustnicą jednoelementową**
*• Grille for circular ducts with vertical blades and single-leaf damper*

KSV-P-2



L [mm]	125	225	325	425	525	625	825	1025	1225
H [mm]	Cena [PLN/szt.] • Price [PLN/pc]								
75	69,00	81,00	93,00	109,00	126,00	168,00	206,00	260,00	328,00
125	74,00	89,00	106,00	118,00	139,00	187,00	226,00	289,00	352,00
225	×	103,00	125,00	146,00	171,00	226,00	274,00	352,00	425,00
325	×	×	141,00	172,00	199,00	271,00	334,00	426,00	501,00
425	×	×	×	198,00	247,00	334,00	407,00	501,00	596,00
525	×	×	×	×	283,00	407,00	487,00	596,00	702,00
625	×	×	×	×	×	476,00	579,00	702,00	844,00

Wykonanie: blacha kwasoodporna - cena × 4 • Execution: acid resistant sheet - price × 4

Malowanie na kolor niestandardowy +20% • Painting in not standard color +20%

Wymiary otworu montażowego L/H • Size of the assembly opening L/H

Inne wymiary na zapytanie • Other dimensions for enquiry



# Centrale wentylacyjne SW50+

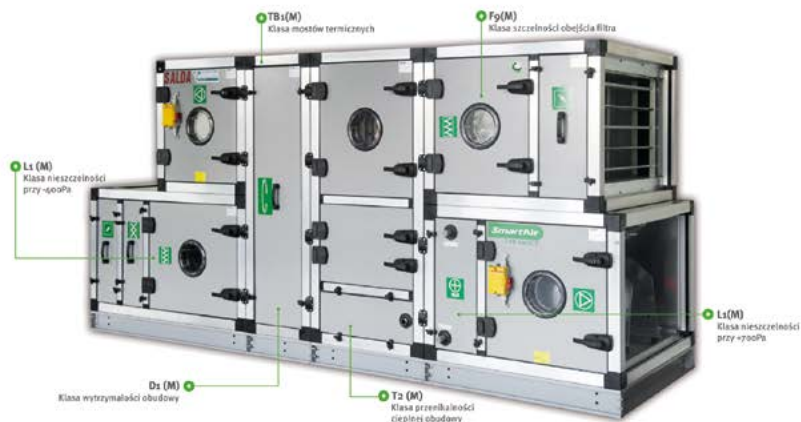

## SW50+ centrala z klasą!

- ✓ **Innowacyjna konstrukcja obudowy**
- ✓ **Niezwykłe szczelna i lekka**
- ✓ **Maksymalnie wyeliminowane mostki termiczne – klasa TB 1 (M)**

**SW50+** marki Salda, dzięki zastosowaniu innowacyjnej obudowy posiada klasę odporności na mostki termiczne TB<sub>1</sub>(M) – potwierdzoną oficjalnym certyfikatem EUROVENT. Tę doskonałą klasę uzyskano dzięki zastosowaniu specjalnego profilu do budowy central. Profil składa się z płaszczyzn aluminiowych, w których zamocowano specjalne wstawki wykonane z tworzywa sztucznego (nylon) o bardzo dobrych właściwościach izolacyjnych dla przewodnictwa termicznego. Taka konstrukcja i materiały zapewniają odpowiednią izolację centrali a co za tym idzie wydajną pracę urządzenia.

Wejdź na [www.amberair.pl](http://www.amberair.pl) dowiedz się więcej o SW50+.





## Centrala nawiewna • Air supply unit

## VEGA



- 3 modele z 3 różnymi nagrzewnicami elektrycznymi i model z nagrzewnicą wodną
- 6 możliwych pozycji montażu
- najniższa wysokość w swojej klasie
- nowoczesny i automatyczny system kontroli, integracja z systemami zarządzania budynkiem (RS-485)
- 3 models with 3 different electrical heaters and model with water heater
- 6 mounting positions
- lowest height in the class
- modern automatic control. Integration with building management system

Typ • Type	Wydajń./spręż <sup>1)</sup> • Air flow/compression range <sup>1)</sup> [m <sup>3</sup> /h] / [Pa]	Wymiary <sup>2)</sup> • Unit size <sup>2)</sup> [mm]	Nagrzew- -wnica • Heater capacity [kW]	Przyłącze • Ducts connection [mm]	Zasilanie • Supply voltage [V/Hz]		Cena [EUR/szt.] • Price [EUR/pc]
					Nagrzew- -nica • Heater	Wentylator • Fan	
<b>VEGA 350</b>	350/100	578×250×1060	1,2 - 5,0	∅ 160	230/50 400/50	230/50	620,00
<b>VEGA 700</b>	800/100	578×300×1260	2,4 - 9,0	∅ 200	230/50 400/50	230/50	700,00
<b>VEGA 1100 E</b>	1180/100	807×340×1400	6,0 - 15,0	500×250	400/50	230/50	990,00
<b>VEGA 1100 W</b>	1150/100	807×340×1400	16,1	500×250	WODNA, ZABUDOWANA	230/50	1 290,00

Nagrzewnice dla VEGA 350 • Heaters for VEGA 350	
<b>EH 1.2 1f</b>	90,00 EUR
<b>EH 2.4 1f</b>	110,00 EUR
<b>EH 5.0 2f</b>	230,00 EUR

Nagrzewnice dla VEGA 700 • Heaters for VEGA 700	
<b>EH 2.4 1f</b>	110,00 EUR
<b>EH 5.0 2f</b>	190,00 EUR
<b>EH 9.0 3f</b>	260,00 EUR

Nagrzewnice dla VEGA 1100 E • Heaters for VEGA 1100 E	
<b>EH 6.0 2f</b>	200,00 EUR
<b>EH 9.0 3f</b>	260,00 EUR
<b>EH 15.0 3f</b>	390,00 EUR

Sterowniki • Controllers		
<b>FLEX</b>	EUR/szt. • EUR/pc	260,00

<sup>1)</sup> wartości mierzone w punkcie pracy • value at the working point

<sup>2)</sup> szerokość × wysokość × długość • width × height × length

Ceny przeliczane na PLN w dniu sprzedaży wg kursów średnich NBP.



## Centrala nawiewna • Air supply unit

## VEKA INT EKO



- zamontowany czujnik ciśnienia w przypadku zanieczyszczenia filtra
- niewielka waga - doskonale do montażu podwieszanego
- wentylatory EC ograniczające zużycie energii i koszty użytkowania
- opcjonalna klasa filtrów: G3, F5 lub F7
- cicha i niezawodna praca
- zabudowana przepustnica z silnikiem

- installed pressure switch for filter pollution
- low height - perfect for under ceilings installation
- EC fan for saving energy and money
- optional filters class: G4, F5 or F7
- quiet and long-life unit



Typ • Type	Wydajność/spręż <sup>*)</sup> • Air flow/ compression range <sup>*)</sup> [m <sup>3</sup> /h] / [Pa]	Wymiary <sup>**)</sup> • Unit size <sup>**)</sup> [mm]	Nagrze- wnica • Heater capacity [kW]	Przyłącze • Ducts connection [mm]	Zasilanie • Supply voltage [V/Hz]		Cena [EUR/szt.] • Price [EUR/pc]
					Nagrzew- nica • Heater	Wentylator • Fan	
<b>Nagrzewnice elektryczne • Electrical heaters</b>							
VEKA INT 400-1,2 L1 EKO	580/100	450×325×1190	1,2	Ø 200	230/50	230/50	1 260,00
VEKA INT 400-2,0 L1 EKO	580/100	450×325×1190	2,0	Ø 200	230/50	230/50	1 290,00
VEKA INT 400-5,0 L1 EKO	580/100	450×325×1190	5,0	Ø 200	400/50	230/50	1 330,00
VEKA INT 700-2,4 L1 EKO	900/100	500×350×1280	2,4	Ø 250	230/50	230/50	1 410,00
VEKA INT 700-5,0 L1 EKO	900/100	500×350×1280	5,0	Ø 250	400/50	230/50	1 450,00
VEKA INT 700-9,0 L1 EKO	900/100	500×350×1280	9,0	Ø 250	400/50	230/50	1 540,00
VEKA INT 1000-2,4 L1 EKO	1100/100	635×350×1350	2,4	400×200	230/50	230/50	1 580,00
VEKA INT 1000-5,0 L1 EKO	1100/100	635×350×1350	5,0	400×200	400/50	230/50	1 620,00
VEKA INT 1000-9,0 L1 EKO	1100/100	635×350×1350	9,0	400×200	400/50	230/50	1 720,00
VEKA INT 1000-12,0 L1 EKO	1100/100	635×350×1350	12,0	400×200	400/50	230/50	1 770,00
VEKA INT 2000-6,0 L1 EKO	2550/100	750×460×1650	6,0	500×250	400/50	230/50	2 200,00
VEKA INT 2000-15,0 L1 EKO	2550/100	750×460×1650	15,0	500×250	400/50	230/50	2 350,00
VEKA INT 2000-21,0 L1 EKO	2550/100	750×460×1650	21,0	500×250	400/50	230/50	2 510,00

\*) wartości mierzone w punkcie pracy • value at the working point

\*\*) szerokość × wysokość × długość • width × height × length

Ceny przeliczane na PLN w dniu sprzedaży wg kursów średnich NBP.





Typ • Type	Wydajn./spręż <sup>1)</sup> • Air flow/ compression range <sup>2)</sup> [m <sup>3</sup> /h] / [Pa]	Wymiary <sup>3)</sup> • Unit size <sup>3)</sup> [mm]	Nagrze- -wnica • Heater capacity [kW]	Przyłącze • Ducts connection [mm]	Zasilanie • Supply voltage [V/Hz]		Cena [EUR/szt.] • Price [EUR/pc]
					Nagrzew- -nica • Heater	Wentyl- -lator • Fan	
<b>Nagrzewnice elektryczne</b> • Electrical heaters							
VEKA INT 3000-15,0 L1 EKO	3500/250	950×550×1500	15,0	700×400	400/50	230/50	3 600,00
VEKA INT 3000-21,0 L1 EKO	3500/250	950×550×1500	21,0	700×400	400/50	230/50	3 760,00
VEKA INT 3000-30,0 L1 EKO	3500/250	950×550×1500	30,0	700×400	400/50	230/50	3 850,00
VEKA INT 3000-39,0 L1 EKO	3500/250	950×550×1500	39,0	700×400	400/50	230/50	4 080,00
VEKA INT 4000-21,0 L1 EKO	4700/200	950×550×1800	21,0	700×400	400/50	230/50	4 060,00
VEKA INT 4000-27,0 L1 EKO	4700/200	950×550×1800	27,0	700×400	400/50	230/50	4 180,00
VEKA INT 4000-39,0 L1 EKO	4700/200	950×550×1800	39,0	700×400	400/50	230/50	4 430,00
VEKA INT 4000-54,0 L1 EKO	4700/200	950×550×1800	54,0	700×400	400/50	230/50	4 510,00
<b>Nagrzewnice wodne</b> • Water heaters							
VEKA INT 1000 W L1 EKO	1000/100	635×350×1350	14,4	400×200	WODNA • WATER	230/50	1 720,00
VEKA INT 2000 W L1 EKO	2000/300	750×460×1650	27,0	500×250	WODNA • WATER	230/50	2 850,00
VEKA INT 3000 W L1 EKO	3500/250	950×550×1500	40,6	700×400	WODNA • WATER	230/50	3 870,00
VEKA INT 4000 W L1 EKO	4500/250	950×550×1800	54,0	700×400	WODNA • WATER	230/50	4 040,00

## Zestaw do centrali z nagrzewnicą wodną (zawór + siłownik + śrubunek)

<b>ZS</b>	EUR/szt. • EUR/pc	300,00
-----------	-------------------	--------

## Sterownik • Controller

<b>FLEX</b>	EUR/szt. • EUR/pc	260,00
-------------	-------------------	--------

<sup>1)</sup> wartości mierzone w punkcie pracy • value at the working point<sup>2)</sup> szerokość × wysokość × długość • width × height × length

Ceny przeliczane na PLN w dniu sprzedaży wg kursów średnich NBP.

**Centrala wentylacyjna z odzyskiem ciepła**
*• Air handling unit with heat recovery*
**SMARTY**
**ODZYSK DO 92%.**

Silniki EC.

Automatyka sterowania.

 Regulowana wydajność powietrza  
i temperatura powietrza nawiewanego.

*RECUPERATION UP 92%.*
*EC motors.*
*Integrated control.*
*Controlled air flow*
*and supply air temperature control.*

**Wymiennik przeciwprądowy.**

Grubość ścianek: 30 mm.

Klasa filtra nawiew/wywiew: G4/G4.

*Counter-flow heat exchanger.*
*Wall thickness: 30 mm.*
*Supply/Exhaust filter class: G4/G4.*
**Wymiennik obrotowy.**

Grubość ścianek: 20 mm.

Klasa filtra nawiew/wywiew: M5/M5.

*Rotor heat exchanger.*
*Wall thickness: 20 mm.*
*Supply/Exhaust filter class: M5/M5.*
**V** - układ pionowy

**P** - podsufitowe

**E** - nagrzewnica elektr.

*V - vertical set*
*P - under-ceiling*
*E - electric heater*

Model	Wydajność/spręż <sup>1)</sup> • Efficiency/Compression range [m <sup>3</sup> /h] / [Pa]	Moc nagrzewnicy • Heater capacity [kW]	Przyłącze • Connection [mm]	Cena katalogowa • Price [EUR/szt.] • [EUR/pc]
Centrale wentylacyjne z wymiennikiem przeciwprądowym				
<b>Smarty 2X V 1.1<sup>***</sup></b>	180 / 100	0,6	125	1 650,00
<b>Smarty 2X P 1.1</b>	230 / 100	EKA NIS <sup>**</sup> )	125	1 550,00
<b>Smarty 3X V 1.1<sup>***</sup></b>	420 / 100	1,2	160	1 900,00
<b>Smarty 3X P 1.1</b>	400 / 100	EKA NIS <sup>**</sup> )	160	1 800,00
<b>Smarty 4X V 1.1<sup>***</sup></b>	590 / 100	1,2	160	2 290,00
<b>Smarty 4X P 1.1</b>	590 / 100	EKA NIS <sup>**</sup> )	160	2 230,00
Centrala wentylacyjna z wymiennikiem obrotowym				
<b>Smarty 2R VE PLUS</b>	210 / 100	0,6	125	1 820,00

Sterowniki • Controllers		
<b>WIFSET</b>	EUR/szt. • EUR/pc	260,00
<b>SA-CONTROL</b>		300,00

<sup>1)</sup> wartości mierzone w punkcie pracy • value at the working point

<sup>\*\*</sup> nagrzewnica elektryczna kanałowa (dopłata) • duct electrical heater (additional payment)

<sup>\*\*\*</sup> przy montażu na podłodze wymagane nóżki (dopłata) • when mounting on the floor, assembling supports is necessary (additional payment)

Ceny przeliczone na PLN w dniu sprzedaży wg kursów średnich NBP.



## Centrala wentylacyjna z odzyskiem ciepła

• Air handling unit with heat recovery

## RIS V EKO 3.0

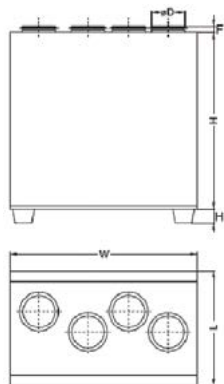

Model	Wymiary • Dimensions [mm]					
	L	W	H	ØD	H <sub>1</sub>	F
<b>RIS 700 V EKO</b>	670	1000	980	250	126	40
<b>RIS 1200 V EKO</b>	760	1350	1200	315	126	40
<b>RIS 1900 V EKO</b>	800	2000	1600	400	140	70
<b>RIS 2200 V EKO</b>	800	2000	1600	400	140	70

Model	Akcesoria • Accessories												
	FLEX STOUCH	1141 RC02-F2 KFF-U	AVS	AVA	EKA NV PH	PS	SP	SSB GRZA- NIE	SSB CHŁO- DZENIE	RMG		VVP/VXP	
										80/60°C	60/40°C	80/60°C	60/40°C
<b>RIS 700 VE EKO</b>	+	+	-	250	250	int	*	-	81	-	-	-	-
<b>RIS 700 VW EKO</b>	+	+	250	250	250	int	**	61	81	3-1,0-4	3-0,63-4	45.10-1,0	45.10-0,63
<b>RIS 1200 VE EKO</b>	+	+	-	315	315	int	*	-	81	-	-	-	-
<b>RIS 1200 VW EKO</b>	+	+	315	315	315	int	**	61	81	3-0,63-4	3-0,63-4	45.10-0,63	45.10-0,63
<b>RIS 1900 VE EKO</b>	+	+	-	400	400	int	*	-	81				
<b>RIS 1900 VW EKO</b>	+	+	400	400	400	int	**	61	81				
<b>RIS 2200 VE EKO</b>	+	+	-	400	400	int	*	-	81				
<b>RIS 2200 VW EKO</b>	+	+	400	400	400	int	**	61	81				

int - zintegrowane • integrated

\* - LM230A-TP

\*\* - NF230A

**FLEX / STOUCH** - sterowniki • controllers | **1141** - czujnik ciśn. • pressure transmitter | **RC02-F2** - czujnik CO<sub>2</sub> (pomieszcz., bez LCD, 0-10V) • CO<sub>2</sub> sensor (room, without display, 0-10V) | **KFF-U** - czujnik wilgotn. (kanał., 0-10V) • humidity sensor (duct, 0-10V) | **AVS** - nagrzewnica wodna • water heater | **AVA** - chłodnica wodna • water cooler | **EKA/EKA NIS PH** - nagrzewnica elektr. • electrical heater | **PS** - przełącznik różnicowo-ciśnieniowy • differential pressure switch | **SP** - siłownik przepustnicy • actuator for dampers | **SSB** - siłownik zaworu wody term. • thermic water valve actuator | **RMG** - układ mieszający • mixing point | **VVP/VXP** - zawory • valves



## Centrala wentylacyjna z odzyskiem ciepła

• Air handling unit with heat recovery

RIS VE EKO 3.0



V - układ pionowy • vertical set

E - nagrzewnica elektryczna • electric heater

Wymiennik przeciwprądowy: **ODZYSK DO 94%**.

Grubość ścianek: 30-50 mm.

Klasa filtra nawiewnego: F7.

Klasa filtra wywiewnego: F5.

Silniki EC.

Automatyka sterowania.

Regulowana wydajność powietrza i temperatura powietrza nawiewanego.

*Counter-flow heat exchanger: RECUPERATION UP 94%.**Wall thickness: 30-50 mm.**Supply filter class: F7.**Exhaust filter class: F5.**EC motors.**Integrated control.**Controlled air flow and supply air temperature control.*

Model	Wydajność/spręż <sup>*)</sup> • Efficiency/Compression range [m <sup>3</sup> /h] / [Pa]	Moc nagrzewnicy • Heater capacity [kW]	Przyłącze • Connection [mm]	Cena katalogowa • Price [EUR/szt.] • [EUR/pc]
RIS 700 VE EKO 3.0	800/100	1,2	Ø 250	2 890,00
RIS 1200 VE EKO 3.0	1200/200	2,0	Ø 315	4 420,00
RIS 1900 VE EKO 3.0	2000/200	3,0	Ø 400	6 620,00
RIS 2200 VE EKO 3.0	2200/200	3,0	Ø 400	6 960,00

Sterowniki • Controllers		
FLEX	EUR/szt. • EUR/pc	260,00
WIFSET		260,00
SA-CONTROL		300,00

\*) wartości mierzone w punkcie pracy • value at the working point

Ceny przeliczone na PLN w dniu sprzedaży wg kursów średnich NBP.



## Centrala wentylacyjna z odzyskiem ciepła

• Air handling unit with heat recovery

## RIS VW EKO 3.0



V - układ pionowy • vertical set

W - nagrzewnica wodna • water heater

Wymiennik przeciwprądowy: **ODZYSK DO 94%**.

Grubość ścianek: 30-50 mm.

Klasa filtra nawiewnego: F7.

Klasa filtra wywiewnego: F5.

Silniki EC.

Automatyka sterowania.

Regulowana wydajność powietrza i temperatura powietrza nawiewanego.

Counter-flow heat exchanger: RECOVERY UP 94%.

Wall thickness: 30-50 mm.

Supply filter class: F7.

Exhaust filter class: F5.

EC motors.

Integrated control.

Controlled air flow and supply air temperature control.

Model	Wydajność/spręż <sup>*)</sup> • Efficiency/Compression range [m <sup>3</sup> /h] / [Pa]	Moc nagrzewnicy • Heater capacity [kW]	Przyłącze • Connection [mm]	Cena katalogowa • Price [EUR/szt.] • [EUR/pc]
RIS 700 VW EKO 3.0	800/100	AVS 250 <sup>**)</sup>	Ø 250	2 840,00
RIS 1200 VW EKO 3.0	1200/200	AVS 315 <sup>**)</sup>	Ø 315	4 470,00
RIS 1900 VW EKO 3.0	2000/200	AVS 400 <sup>**)</sup>	Ø 400	6 520,00
RIS 2200 VW EKO 3.0	2200/200	AVS 400 <sup>**)</sup>	Ø 400	6 900,00

Zestaw do centrali z nagrzewnicą wodną (zawór + siłownik + śrubunek)		
ZS	EUR/szt. • EUR/pc	300,00

Sterowniki • Controllers		
FLEX	EUR/szt. • EUR/pc	260,00
WIFSET		260,00
SA-CONTROL		300,00

\*) wartości mierzone w punkcie pracy • value at the working point

\*\*) nagrzewnica montowana na kanale (dopłata) • heater on canal (additional payment)

Ceny przeliczone na PLN w dniu sprzedaży wg kursów średnich NBP.



## Centrala wentylacyjna z odzyskiem ciepła

• Air handling unit with heat recovery

## RIS H EKO 3.0

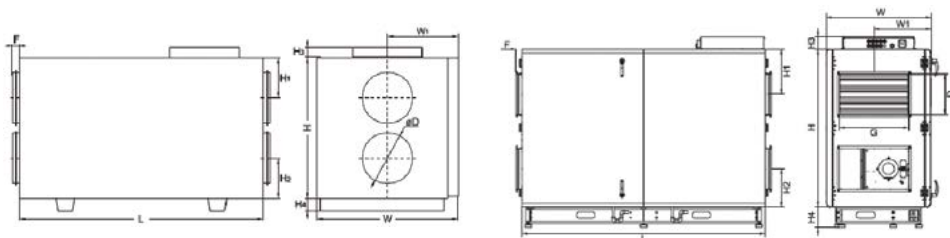

RIS 700-2200 H EKO

RIS 2500 H EKO

Model	Wymiary • Dimensions [mm]											
	L	W	W <sub>1</sub>	ØD	G	D	H	H <sub>1</sub>	H <sub>2</sub>	H <sub>3</sub>	H <sub>4</sub>	F
<b>RIS 700 H EKO</b>	1200	670	335	250	-	-	780	210	210	-	126	40
<b>RIS 1200 H EKO</b>	1500	760	380	315	-	-	1200	269	269	70	141	40
<b>RIS 1900 H EKO</b>	1800	800	400	400	-	-	1245	331	331	106	141	70
<b>RIS 2200 H EKO</b>	1800	800	400	400	-	-	1245	331	331	106	141	70
<b>RIS 2500 H EKO</b>	2100	900	490	-	600	350	1355	387	327	108	180	50

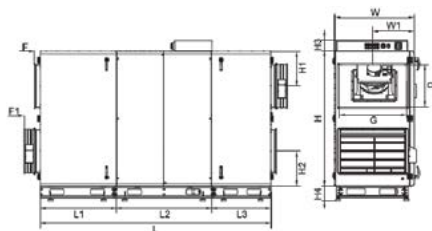

RIS 3500 H EKO

Model	Wymiary • Dimensions [mm]														
	L	L <sub>1</sub>	L <sub>2</sub>	L <sub>3</sub>	W	W <sub>1</sub>	G	D	H	H <sub>1</sub>	H <sub>2</sub>	H <sub>3</sub>	H <sub>4</sub>	F	F <sub>1</sub>
<b>RIS 3500 H EKO</b>	2756	909	1132	709	946	494	800	500	1600	413	413	129	180	65	192



## Centrala wentylacyjna z odzyskiem ciepła

• Air handling unit with heat recovery

## RIS H EKO 3.0

Model	Akcesoria • Accessories												
	FLEX STOUCH	1141 RC02-F2 KFF-U	SVS	AVS	AVA	SP	SSB GRZA- NIE	SBB CHLO- DZENIE	RMG		VVP/VXP		Comfort Box
									80/60°C	60/40°C	80/60°C	60/40°C	
RIS 700 HE EKO	+	+	-	250	250	*	-	81	-	-	-	-	-
RIS 700 HW EKO	+	+	-	250	250	**	61	81	3-1,0-4	3-0,63-4	45.10-1,1	45.10-0,63	-
RIS 1200 HE EKO	+	+	-	315	315	*	-	81	-	-	-	-	-
RIS 1200 HW EKO	+	+	-	315	315	**	61	81	3-0,63-4	3-0,63-4	45.10-0,63	45.10-0,63	-
RIS 1900 HE EKO	+	+	-	400	400	*	-	81					400
RIS 1900 HW EKO	+	+	-	400	400	**	61	81					400
RIS 2200 HE EKO	+	+	-	400	400	*	-	81					400
RIS 2200 HW EKO	+	+	-	400	400	**	61	81					400
RIS 2500 HE EKO	+	+	600×350	-	-	int	-	81					600×350
RIS 2500 HW EKO	+	+	600×350	-	-	int	61	81					600×350
RIS 3500 HE EKO	+	+	800×500	-	-	int	-	81					800×500
RIS 3500 HW EKO	+	+	800×500	-	-	int	61	81					800×500

int - zintegrowane • integrated

\* - LM230A-TP

\*\* - NF230A

Doboru układów RMG i zaworów VVP/VXP można dokonać na stronie: [via.salda.it](http://via.salda.it)

Zamawiając RIS 1900-5500 HW EKO i SVS/AVS należy również zamówić czujnik powrotu wody (TJP 10K) i termostat kanałowy (CO4C).

FLEX / STOUCH - sterowniki • controllers | 1141 - czujnik ciśn. • pressure transmitter | RC02-F2 - czujnik CO<sub>2</sub> (pomieszcz., bez LCD, 0-10V) • CO<sub>2</sub> sensor (room, without display, 0-10V) | KFF-U - czujnik wilgotn. (kanał., 0-10V) • humidity sensor (duct, 0-10V) | SVS - nagrzewnica do kanałów prostokątnych • heating coil for rectangular ducting | AVS - nagrzewnica wodna • water heater | AVA - chłodnica wodna • water cooler | SP - siłownik przepustnicy • actuator for dampers | SSB - siłownik zaworu wody term. • thermic water valve actuator | RMG - układ mieszający • mixing point | VVP/VXP - zawory • valves



## Centrala wentylacyjna z odzyskiem ciepła

• Air handling unit with heat recovery

## RIS HE EKO 3.0

**H** - układ poziomy • horizontal set**E** - nagrzewnica elektryczna • electrical heaterWymiennik przeciwprądowy: **ODZYSK DO 94%**.

Grubość ścianek: 30-50 mm.

Klasa filtra nawiewnego: F7.

Klasa filtra wywiewnego: F5.

Silniki EC.

Automatyka sterowania.

Regulowana wydajność powietrza i temperatura powietrza nawiewanego.

*Counter-flow heat exchanger: RECUPERATION UP 94%.**Wall thickness: 30-50 mm.**Supply filter class: F7.**Exhaust filter class: F5.**EC motors.**Integrated control.**Controlled air flow and supply air temperature control.*

Model	Wydajność/spręż <sup>1)</sup> • Efficiency/Compression range [m <sup>3</sup> /h] / [Pa]	Moc nagrzewnicy • Heater capacity [kW]	Przyłącze • Connection [mm]	Cena katalogowa • Price [EUR/szt.] • [EUR/pc]
RIS 700 HE EKO 3.0	750/100	1,2	Ø 250	2 890,00
RIS 1200 HE EKO 3.0	1200/200	2,0	Ø 315	4 580,00
RIS 1900 HE EKO 3.0	1820/200	3,0	Ø 400	6 410,00
RIS 2200 HE EKO 3.0	2100/200	3,0	Ø 400	7 030,00
RIS 2500 HE EKO 3.0	2700/200	3,6	600×350	8 220,00
RIS 3500 HE EKO 3.0	3700/200	6,0	800×500	9 350,00

Sterowniki • Controllers		
FLEX	EUR/szt. • EUR/pc	260,00
WIFSET		260,00
SA-CONTROL		300,00

<sup>1)</sup> wartości mierzone w punkcie pracy • value at the working point

Ceny przeliczane na PLN w dniu sprzedaży wg kursów średnich NBP.





## Centrala wentylacyjna z odzyskiem ciepła

• Air handling unit with heat recovery

## RIS HW EKO 3.0



H - układ poziomy • horizontal set

W - nagrzewnica wodna • water heater

Wymiennik przeciwprądowy: **ODZYSK DO 94%**.

Grubość ścianek: 30-50 mm.

Klasa filtra nawiewnego: F7.

Klasa filtra wywiewnego: F5.

Silniki EC.

Automatyka sterowania.

Regulowana wydajność powietrza i temperatura powietrza nawiewanego.

*Counter-flow heat exchanger: RECUPERATION UP 94%.**Wall thickness: 30-50 mm.**Supply filter class: F7.**Exhaust filter class: F5.**EC motors.**Integrated control.**Controlled air flow and supply air temperature control.*

Model	Wydajność/spręż <sup>1)</sup> • Efficiency/Compression range [m <sup>3</sup> /h] / [Pa]	Moc nagrzewnicy • Heater capacity [kW]	Przyłącze • Connection [mm]	Cena katalogowa • Price [EUR/szt.] • [EUR/pc]
RIS 700 HW EKO 3.0	750/100	AVS 250 <sup>2)</sup>	Ø 250	2 840,00
RIS 1200 HW EKO 3.0	1200/200	AVS 315 <sup>2)</sup>	Ø 315	4 430,00
RIS 1900 HW EKO 3.0	1820/200	AVS 400 <sup>2)</sup>	Ø 400	6 200,00
RIS 2200 HW EKO 3.0	2100/200	AVS 400 <sup>2)</sup>	Ø 400	6 990,00
RIS 2500 HW EKO 3.0	2700/200	SVS 600×350 <sup>2)</sup>	600×350	8 130,00
RIS 3500 HW EKO 3.0	3700/200	SVS 800×500 <sup>2)</sup>	800×500	9 180,00

Zestaw do centrali z nagrzewnicą wodną (zawór + siłownik + śrubunek)		
ZS	EUR/szt. • EUR/pc	300,00

Sterowniki • Controllers		
FLEX	EUR/szt. • EUR/pc	260,00
WIFSET		260,00
SA-CONTROL		300,00

<sup>1)</sup> wartości mierzone w punkcie pracy • value at the working point<sup>2)</sup> nagrzewnica montowana na kanale (dopłata) • heater on canal (additional payment)

Ceny przeliczone na PLN w dniu sprzedaży wg kursów średnich NBP.



## Centrala wentylacyjna z odzyskiem ciepła

• Air handling unit with heat recovery

## RIS PE EKO 3.0



P - podsufitowe • under-ceiling

E - nagrzewnica elektryczna • electrical heater

Wymiennik przeciwprądowy: **ODZYSK DO 94%**.

Grubość ścianek: 30-50 mm.

Klasa filtra nawiewnego: F7.

Klasa filtra wywiewnego: F5.

Silniki EC.

Automatyka sterowania.

Regulowana wydajność powietrza i temperatura powietrza nawiewanego.

Counter-flow heat exchanger: RECOVERY UP 94%.

Wall thickness: 30-50 mm.

Supply filter class: F7.

Exhaust filter class: F5.

EC motors.

Integrated control.

Controlled air flow and supply air temperature control.

Model	Wydajność/spręż <sup>1)</sup> • Efficiency/Compression range [m <sup>3</sup> /h] / [Pa]	Moc nagrzewnicy • Heater capacity [kW]	Przyłącze • Connection [mm]	Cena katalogowa • Price [EUR/szt.] • [EUR/pc]
RIS 400 PE 0.9 EKO 3.0 RIS 400 PE 1.6 EKO 3.0 RIS 400 PE 3.0 EKO 3.0	390/200	0,9 1,6 3,0	Ø 200	2 550,00 2 590,00 2 720,00
RIS 700 PE 1.2 EKO 3.0 RIS 700 PE 3.0 EKO 3.0 RIS 700 PE 4.5 EKO 3.0	650/200	1,2 3,0 4,5	Ø 250	2 900,00 2 970,00 3 050,00
RIS 1200 PE 3.0 EKO 3.0 RIS 1200 PE 6.0 EKO 3.0 RIS 1200 PE 9.0 EKO 3.0	1200/200	3,0 6,0 9,0	500×250	4 960,00 5 160,00 5 200,00
RIS 1900 PE 3.0 EKO 3.0 RIS 1900 PE 6.0 EKO 3.0 RIS 1900 PE 12.0 EKO 3.0	1700/200	3,0 6,0 12,0	700×300	6 840,00 6 960,00 7 160,00
RIS 2500 PE 4.5 EKO 3.0 RIS 2500 PE 9.0 EKO 3.0 RIS 2500 PE 18.0 EKO 3.0	2400/200	4,5 9,0 18,0	700×400	7 990,00 8 110,00 8 350,00

## Sterowniki • Controllers

FLEX	EUR/szt. • EUR/pc	260,00
WIFSET		260,00
SA-CONTROL		300,00

<sup>1)</sup> wartości mierzone w punkcie pracy • value at the working point

Ceny przeliczane na PLN w dniu sprzedaży wg kursów średnich NBP.



## Centrala wentylacyjna z odzyskiem ciepła

• Air handling unit with heat recovery

## RIS PW EKO 3.0



P - podsufitowe • under-ceiling

W - nagrzewnica wodna • water heater

Wymiennik przeciwprądowy: **ODZYSK DO 94%**.

Grubość ścianek: 30-50 mm.

Klasa filtra nawiewnego: F7.

Klasa filtra wywiewnego: F5.

Silniki EC.

Automatyka sterowania.

Regulowana wydajność powietrza i temperatura powietrza nawiewanego.

*Counter-flow heat exchanger: RECUPERATION UP 94%.**Wall thickness: 30-50 mm.**Supply filter class: F7.**Exhaust filter class: F5.**EC motors.**Integrated control.**Controlled air flow and supply air temperature control.*

Model	Wydajność/spręż <sup>1)</sup> • Efficiency/Compression range [m <sup>3</sup> /h] / [Pa]	Moc nagrzewnicy • Heater capacity [kW]	Przyłącze • Connection [mm]	Cena katalogowa • Price [EUR/szt.] • [EUR/pc]
RIS 400 PW EKO 3.0	400/200	AVS 200 <sup>2)</sup>	Ø 200	2 340,00
RIS 700 PW EKO 3.0	700/200	AVS 250 <sup>2)</sup>	Ø 250	2 880,00
RIS 1200 PW EKO 3.0	1200/200	SVS 500×250 <sup>2)</sup>	500×250	5 010,00
RIS 1900 PW EKO 3.0	1700/200	SVS 700×400 <sup>2)</sup>	700×400	6 730,00
RIS 2500 PW EKO 3.0	2400/200	SVS 700×400 <sup>2)</sup>	700×400	7 880,00

Zestaw do centrali z nagrzewnicą wodną (zawór + siłownik + śrubunek)		
ZS	EUR/szt. • EUR/pc	300,00

Sterowniki • Controllers		
FLEX	EUR/szt. • EUR/pc	260,00
WIFSET		260,00
SA-CONTROL		300,00

<sup>1)</sup> wartości mierzone w punkcie pracy • value at the working point<sup>2)</sup> nagrzewnica montowana na kanale (dopłata) • heater on canal (additional payment)

Ceny przeliczane na PLN w dniu sprzedaży wg kursów średnich NBP.



## Centrala wentylacyjna z odzyskiem ciepła

• Air handling unit with heat recovery

## RIRS V EKO 3.0

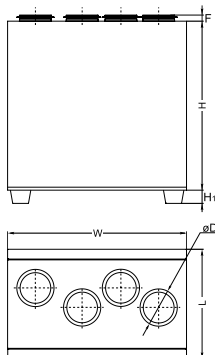

RIRS 400-700 V EKO

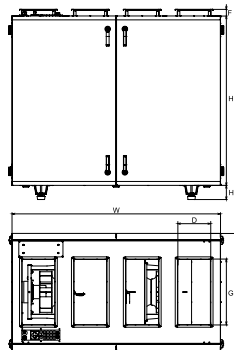

RIRS 1200-2500 V EKO

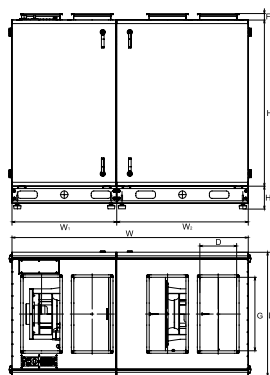

RIRS 3500 V EKO

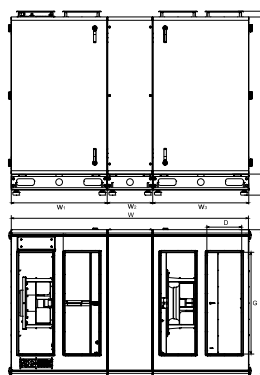

RIRS 5500 V EKO

Model	Wymiary • Dimensions [mm]										
	W				L	H	H <sub>1</sub>	ØD	D	G	F
RIRS 400 V EKO	900	-	-	-	560	850	40	160	-	-	30
RIRS 700 V EKO	1100	-	-	-	655	980	40	250	-	-	40
RIRS 1200 V EKO	1500	-	-	-	855	1150	70	315	-	-	40
RIRS 1900 V EKO	1500	-	-	-	855	1150	70	315	-	-	40
RIRS 2500 V EKO	1600	-	-	-	900	1300	110	-	250	500	50
RIRS 3500 V EKO	1930	850	1075	-	1010	1355	190	-	300	600	50
RIRS 5500 V EKO	2120	855	400	855	1310	1400	190	-	300	900	50



## Centrala wentylacyjna z odzyskiem ciepła

• Air handling unit with heat recovery

## RIRS V EKO 3.0

Model	Akcesoria • Accessories											
	FLEX STOUCH	1141 RC02-F2 KFF-U	AVS	AVA	SSK SKS LJ/PG	TJP 10K CO4C	SSB GRZANIE	SSB CHŁODZ.	RMG		VVP/VXP	
									80/60°C	60/40°C	80/60°C	60/40°C
RIRS 400 VE EKO	+	+	-	160	-	-	-	81	-	-	-	-
RIRS 700 VE EKO	+	+	-	250	-	-	-	81	-	-	-	-
RIRS 1200 VE EKO	+	+	-	315	-	-	-	81	-	-	-	-
RIRS 1200 VW EKO	+	+	315	315	-	int	61	81	3-1,0-4	3-1,0-4	45.10-1,0	45.10-1,0
RIRS 1900 VE EKO	+	+	-	315	-	-	-	81	-	-		
RIRS 1900 VW EKO	+	+	315	315	-	int	61	81	3-1,0-4	3-1,0-4	45.10-1,0	45.10-1,0
RIRS 2500 VE EKO	+	+	-	-	500x250	-	-	81	Doboru układów RMG i zaworów VVP/VXP można dokonać na stronie: <a href="http://via.salda.it">via.salda.it</a>			
RIRS 2500 VW EKO	+	+	-	-	500x250	int	61	81				
RIRS 3500 VE EKO	+	+	-	-	600x300	-	-	81				
RIRS 3500 VW EKO	+	+	-	-	600x300	int	61	81				
RIRS 5500 VE EKO	+	+	-	-	800x500*	-	-	81				
RIRS 5500 VW EKO	+	+	-	-	800x500*	int	61	81				

int - zintegrowane • integrated

\* - wymagany adapter kolnierzyowy STP

FLEX / STOUCH - sterowniki • controllers | 1141 - czujnik ciśn. • pressure transmitter | RC02-F2 - czujnik CO<sub>2</sub> (pomieszcz., bez LCD, 0-10V) • CO<sub>2</sub> sensor (room, without display, 0-10V) | KFF-U - czujnik wilgotn. (kanał., 0-10V) • humidity sensor (duct, 0-10V) | AVS - nagrzewnica wodna • water heater | AVA - chłodnica wodna • water cooler | SSK - przepustnica do kanałów prostokątnych • damper for rectangular duct | SKS - tłumik prostokątny • rectangular duct silencer | LJ/PG - kolnierzyowe przyłącza elastyczne • flexible connection | PS - przełącznik różnicowo-ciśnieniowy • differential pressure switch | TJP 10K - czujnik powrotu wody • temp. sensor | CO4C - termostat antyzamrożeniowy • anti-frost thermostat | SSB - siłownik zaworu wody termicznej • thermic water valve actuator | RMG - układ mieszający • mixing point | VVP/VXP - zawory • valves



## Centrala wentylacyjna z odzyskiem ciepła

• Air handling unit with heat recovery

## RIRS VE EKO 3.0



V - układ pionowy • vertical set

E - nagrzewnica elektryczna • electric heater

Wymiennik obrotowy: **ODZYSK DO 80%**.

Grubość ścianek: 20-50 mm.

Klasa filtra nawiewnego: F7.

Klasa filtra wywiewnego: F5.

Silniki EC.

Automatyka sterowania.

Regulowana wydajność powietrza i temperatura powietrza nawiewanego.

Rotor heat exchanger: **RECUPERATION UP 80%**.

Wall thickness: 20-50 mm.

Supply filter class: F7.

Exhaust filter class: F5.

EC motors.

Integrated control.

Controlled air flow and supply air temperature control.

Model	Wydajność/spręż <sup>1)</sup> • Efficiency/Compression range [m <sup>3</sup> /h] / [Pa]	Moc nagrzewnicy • Heater capacity [kW]	Przyłącze • Connection [mm]	Cena katalogowa • Price [EUR/szt.] • [EUR/pc]
RIRS 400 VE EKO 3.0	400/150	1,2	Ø 160	2 210,00
RIRS 700 VE EKO 3.0	750/150	2,0	Ø 250	2 710,00
RIRS 1200 VE EKO 3.0	1350/200	4,5	Ø 315	4 580,00
RIRS 1900 VE EKO 3.0	1850/200	9,0	Ø 315	4 970,00
RIRS 2500 VE EKO 3.0	2500/200	9,0	500×250	7 750,00
RIRS 3500 VE EKO 3.0	3500/200	12,0	600×300	9 530,00
RIRS 5500 VE EKO 3.0	6000/250	18,0	900×300	12 410,00

Sterowniki • Controllers		
FLEX	EUR/szt. • EUR/pc	260,00
WIFSET		260,00
SA-CONTROL		300,00

<sup>1)</sup> wartości mierzone w punkcie pracy • value at the working point

Ceny przeliczane na PLN w dniu sprzedaży wg kursów średnich NBP.



## Centrala wentylacyjna z odzyskiem ciepła

• Air handling unit with heat recovery

RIRS VW EKO 3.0



V - układ pionowy • vertical set

W - nagrzewnica wodna • water heater

Wymiennik obrotowy: **ODZYSK DO 80%**.

Grubość ścianek: 20-50 mm.

Klasa filtra nawiewnego: F5/F7.

Klasa filtra wyciągowego: F5.

Silniki EC.

Automatyka sterowania.

Regulowana wydajność powietrza i temperatura powietrza nawiewanego.

Rotor heat exchanger: *RECUPERATION UP 80%*.

Wall thickness: 20-50 mm.

Supply filter class: F5/F7.

Exhaust filter class: F5.

EC motors.

Integrated control.

Controlled air flow and supply air temperature control.

Model	Wydajność/spręż <sup>1)</sup> • Efficiency/Compression range [m <sup>3</sup> /h] / [Pa]	Moc nagrzewnicy • Heater capacity [kW]	Przyłącze • Connection [mm]	Cena katalogowa • Price [EUR/szt.] • [EUR/pc]
RIRS 400 VW EKO 3.0	400/200	AVS 160 <sup>**)</sup>	Ø 160	2 230,00
RIRS 700 VW EKO 3.0	750/150	AVS 250 <sup>**)</sup>	Ø 250	2 640,00
RIRS 1200 VW EKO 3.0	1350/200	AVS 315 <sup>**)</sup>	Ø 315	4 490,00
RIRS 1900 VW EKO 3.0	1850/200	AVS 315 <sup>**)</sup>	Ø 315	4 910,00
RIRS 2500 VW EKO 3.0	2500/200	SVS 500×250 <sup>**)</sup>	500×250	7 470,00
RIRS 3500 VW EKO 3.0	3500/200	SVS 600×300 <sup>**)</sup>	600×300	9 050,00
RIRS 5500 VW EKO 3.0	6000/250	SVS 800×500 <sup>**)</sup>	900×300	12 220,00

Zestaw do centrali z nagrzewnicą wodną (zawór + siłownik + śrubunek)		
ZS	EUR/szt. • EUR/pc	300,00

Sterowniki • Controllers		
FLEX	EUR/szt. • EUR/pc	260,00
WIFSET		260,00
SA-CONTROL		300,00

<sup>1)</sup> wartości mierzone w punkcie pracy • value at the working point<sup>2)</sup> nagrzewnica montowana na kanale (dopłata) • heater on canal (additional payment)

Ceny przeliczone na PLN w dniu sprzedaży wg kursów średnich NBP.



## Centrala wentylacyjna z odzyskiem ciepła

• Air handling unit with heat recovery

## RIRS H EKO 3.0

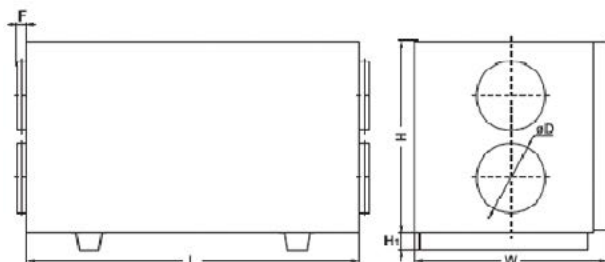

Model	Wymiary • Dimensions [mm]					
	L	W	H	ØD	F	H <sub>1</sub>
<b>RIRS 400 H EKO</b>	1000	560	610	200	30	40
<b>RIRS 700 H EKO</b>	1100	653	700	250	40	40
<b>RIRS 1200 H EKO</b>	1350	853	900	315	40	70
<b>RIRS 1900 H EKO</b>	1350	853	900	315	40	70

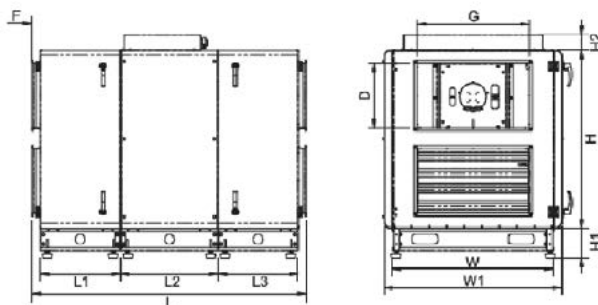

Model	Wymiary • Dimensions [mm]					
	L	W	H	D	F	H <sub>1</sub>
<b>RIRS 2500 H EKO</b>	1608	1110	1105	700×400	50	190
<b>RIRS 3500 H EKO</b>	2005	1205	1433	700×400	50	190
<b>RIRS 5500 H EKO</b>	1908	1394	1485	800×500	50	190





## Centrala wentylacyjna z odzyskiem ciepła

• Air handling unit with heat recovery

## RIRS H EKO 3.0

Model	Akcesoria • Accessories												
	FLEX STOUCH	1141 RC02-F2 KFF-U	AVS AVA	SVS	Comfort Box	SP	TJP 10K CO4C	SSB GRZA- NIE	SBB CHŁO- DZENIE	RMG		VVP/VXP	
										80/60°C	60/40°C	80/60°C	60/40°C
RIRS 400 HE EKO	+	+	-	-	-	*	-	-	-	-	-	-	-
RIRS 400 HW EKO	+	+	160	-	-	**	int	61	81	3-0,63-4	3-0,63-4	45.10-0,63	45.10-0,63
RIRS 700 HE EKO	+	+	-	-	-	*	-	-	-	-	-	-	-
RIRS 700 HW EKO	+	+	250	-	-	**	int	61	81	3-1,0-4	3-0,63-4	45.10-1,1	45.10-0,63
RIRS 1200 HE EKO	+	+	-	-	-	*	-	-	-	-	-	-	-
RIRS 1200 HW EKO	+	+	315	-	-	**	int	61	81	3-1,0-4	3-0,63-4	45.10-1,1	45.10-0,63
RIRS 1900 HE EKO	+	+	-	-	-	*	-	-	-	-	-	-	-
RIRS 1900 HW EKO	+	+	315	-	-	**	int	61	81	3-1,0-4	3-0,63-4	45.10-1,1	45.10-0,63
RIRS 2500 HE EKO	+	+	-	-	600×350	int	-	-	-	-	-	-	-
RIRS 2500 HW EKO	+	+	-	700×400	600×350	int	+	61	81	+	+	+	+
RIRS 3500 HE EKO	+	+	-	-	800×500	int	-	-	-	-	-	-	-
RIRS 3500 HW EKO	+	+	-	700×400	800×500	int	+	61	81	+	+	+	+
RIRS 5500 HE EKO	+	+	-	-	800×500	int	-	-	-	-	-	-	-
RIRS 5500 HW EKO	+	+	-	800×500	800×500	int	+	61	81	+	+	+	+

int - zintegrowane • integrated

\* - LM230A-TP

\*\* - NF230A

FLEX / STOUCH - sterowniki • controllers | 1141 - czujnik ciśn. • pressure transmitter | RC02-F2 - czujnik CO<sub>2</sub> (pomieszcz., bez LCD, 0-10V) • CO<sub>2</sub> sensor (room, without display, 0-10V) | KFF-U - czujnik wilgotn. (kanał., 0-10V) • humidity sensor (duct, 0-10V) | AVS - nagrzewnica wodna • water heater | AVA - chłodnica wodna • water cooler | SVS - nagrzewnica do kanałów prostokątnych • heating coil for rectangular ducting | SP - siłownik przepustnicy • actuator for dampers | TJP 10K - czujnik powrotu wody • temp. sensor | CO4C - termostat antyzamroziowy • anti-frost thermostat | SSB - siłownik zaworu wody term. • thermic water valve actuator | RMG - układ mieszający • mixing point | VVP/VXP - zawory • valves



## Centrala wentylacyjna z odzyskiem ciepła

• Air handling unit with heat recovery

## RIRS HE EKO 3.0

**H** - układ poziomy • horizontal set**E** - nagrzewnica elektryczna • electric heaterWymiennik obrotowy: **ODZYSK DO 80%**.

Grubość ścianek: 50 mm.

Klasa filtra nawiewnego: F7.

Klasa filtra wywiewnego: F5.

Silniki EC.

Automatyka sterowania.

Regulowana wydajność powietrza i temperatura powietrza nawiewanego.

*Rotor heat exchanger: RECUPERATION UP 80%.**Wall thickness: 50 mm.**Supply filter class: F7.**Exhaust filter class: F5.**EC motors.**Integrated control.**Controlled air flow and supply air temperature control.*

Model	Wydajność/spręż <sup>1)</sup> • Efficiency/Compression range [m <sup>3</sup> /h] / [Pa]	Moc nagrzewnicy • Heater capacity [kW]	Przyłącze • Connection [mm]	Cena katalogowa • Price [EUR/szt.] • [EUR/pc]
RIRS 400 HE EKO 3.0	450/150	1,2	Ø 200	2 060,00
RIRS 700 HE EKO 3.0	650/180	2,0	Ø 250	2 590,00
RIRS 1200 HE EKO 3.0	1350/200	4,0	Ø 315	4 530,00
RIRS 1900 HE EKO 3.0	1800/180	9,0	Ø 315	4 850,00
RIRS 2500 HE EKO 3.0	2500/240	9,0	700×400	8 700,00
RIRS 3500 HE EKO 3.0	4100/200	12,0	700×400	10 580,00
RIRS 5500 HE EKO 3.0	6000/270	15,0	800×500	12 510,00

Sterowniki • Controllers		
FLEX	EUR/szt. • EUR/pc	260,00
WIFSET		260,00
SA-CONTROL		300,00

<sup>1)</sup> wartości mierzone w punkcie pracy • value at the working point

Ceny przeliczane na PLN w dniu sprzedaży wg kursów średnich NBP.



## Centrala wentylacyjna z odzyskiem ciepła

• Air handling unit with heat recovery

## RIRS HW EKO 3.0



H - układ poziomy • horizontal set

W - nagrzewnica wodna • water heater

Wymiennik obrotowy: **ODZYSK DO 80%**.

Grubość ścianek: 50 mm.

Klasa filtra nawiewnego: F7.

Klasa filtra wywiewnego: F5.

Silniki EC.

Automatyka sterowania.

Regulowana wydajność powietrza i temperatura powietrza nawiewanego.

Rotor heat exchanger: *RECUPERATION UP 80%*.

Wall thickness: 50 mm.

Supply filter class: F7.

Exhaust filter class: F5.

EC motors.

Integrated control.

Controlled air flow and supply air temperature control.

Model	Wydajność/spręż <sup>1)</sup> • Efficiency/Compression range [m <sup>3</sup> /h] / [Pa]	Moc nagrzewnicy • Heater capacity [kW]	Przyłącze • Connection [mm]	Cena katalogowa • Price [EUR/szt.] • [EUR/pc]
RIRS 400 HW EKO 3.0	450/150	AVS 200 <sup>*)</sup>	Ø 200	2 070,00
RIRS 700 HW EKO 3.0	650/180	AVS 250 <sup>*)</sup>	Ø 250	2 580,00
RIRS 1200 HW EKO 3.0	1350/200	AVS 315 <sup>*)</sup>	Ø 315	4 470,00
RIRS 1900 HW EKO 3.0	1800/180	AVS 315 <sup>*)</sup>	Ø 315	4 810,00
RIRS 2500 HW EKO 3.0	2500/240	Comfort Box 600×350 <sup>*)</sup>	700×400	8 500,00
RIRS 3500 HW EKO 3.0	4100/200	Comfort Box 800×500 <sup>*)</sup>	700×400	10 290,00
RIRS 5500 HW EKO 3.0	6000/270	Comfort Box 800×500 <sup>**)</sup>	800×500	11 930,00

## Zestaw do centrali z nagrzewnicą wodną (zawór + siłownik + śrubunek)

ZS	EUR/szt. • EUR/pc	300,00
----	-------------------	--------

## Sterowniki • Controllers

FLEX	EUR/szt. • EUR/pc	260,00
WIFSET		260,00
SA-CONTROL		300,00

<sup>1)</sup> wartości mierzone w punkcie pracy • value at the working point<sup>2)</sup> nagrzewnica montowana na kanale (dopłata) • heater on canal (additional payment)

Ceny przeliczane na PLN w dniu sprzedaży wg kursów średnich NBP.



## Czujnik wilgotności • Humidity sensor

Typ • Type	Cena [EUR/szt.] • Price [EUR/pc]
<b>S-RFF-U-D-F2</b> POMIESZCZENIE • ROOM	160,00

Typ • Type	Cena [EUR/szt.] • Price [EUR/pc]
<b>S-KFF-U</b> KANAL • DUCT	190,00

Czujniki CO<sub>2</sub> • CO<sub>2</sub> sensor

Typ • Type	Cena [EUR/szt.] • Price [EUR/pc]
<b>S-RCO2-F2</b> POMIESZCZENIE • ROOM	290,00

Typ • Type	Cena [EUR/szt.] • Price [EUR/pc]
<b>S-KCO2</b> KANAL • DUCT	330,00

## Regulator tyrystorowy • Fan speed controller

Typ • Type	Cena [EUR/szt.] • Price [EUR/pc]
<b>ETY-1,5</b>	35,00
<b>ETY-2,5</b>	40,00
<b>MTP010</b>	34,00

Typ • Type	Cena [EUR/szt.] • Price [EUR/pc]
<b>MTY-4</b>	66,00
<b>SMT-D-4P-EL</b>	40,00

## Regulator transformatorowy 400V • Fan speed controller

## TGRT

Typ • Type	Cena [EUR/szt.] • Price [EUR/pc]
<b>TGRT 1</b>	210,00
<b>TGRT 2</b>	240,00
<b>TGRT 3</b>	270,00
<b>TGRT 4</b>	350,00

Typ • Type	Cena [EUR/szt.] • Price [EUR/pc]
<b>TGRT 5</b>	360,00
<b>TGRT 7</b>	420,00
<b>TGRT 11</b>	510,00
<b>TGRT 14</b>	570,00

## Regulator transformatorowy 230V • Fan speed controller

## TGRV

Typ • Type	Cena [EUR/szt.] • Price [EUR/pc]
<b>TGRV 1.5</b>	120,00
<b>TGRV 2</b>	120,00
<b>TGRV 3</b>	140,00
<b>TGRV 4</b>	140,00

Typ • Type	Cena [EUR/szt.] • Price [EUR/pc]
<b>TGRV 5</b>	150,00
<b>TGRV 7</b>	160,00
<b>TGRV 11</b>	190,00
<b>TGRV 14</b>	220,00

Ceny przeliczone na PLN w dniu sprzedaży wg kursów średnich NBP.



Moduł chłodniczo-grzewczy		COMFORT BOX	
Typ • Type	Cena [EUR/szt.] • Price [EUR/pc]	Typ • Type	Cena [EUR/szt.] • Price [EUR/pc]
<b>CB 250 C2+DE</b>	850,00	CB 400 C2+DE	1 270,00
CB 250 C4+DE	910,00	CB 400 C4+DE	1 450,00
CB 250 F2+DE	850,00	CB 400 F4+DE	1 450,00
CB 250 F4+DE	910,00	CB 400 H1	770,00
CB 250 H1	410,00	CB 400 H1+C2+DE	1 160,00
CB 250 H1+C2+DE	990,00	CB 400 H1+C4+DE	1 310,00
CB 250 H1+C4+DE	1 040,00	CB 400 H1+F4+DE	1 310,00
CB 250 H1+F2+DE	990,00	CB 400 H2	810,00
CB 250 H1+F4+DE	1 040,00	CB 400 H2+C2+DE	1 220,00
CB 250 H2	510,00	CB 400 H2+C4+DE	1 390,00
CB 250 H2+C2+DE	1 060,00	CB 400 H2+F4+DE	1 540,00
CB 250 H2+C4+DE	1 120,00	<b>CB 600X350 C2+DE</b>	1 160,00
CB 250 H2+F2+DE	1 060,00	<b>CB 600X350 C4+DE</b>	1 470,00
CB 250 H2+F4+DE	1 120,00	<b>CB 600x350 F4+DE</b>	1 700,00
CB 315 C2+DE	970,00	<b>CB 600x350 H1</b>	890,00
CB 315 C4+DE	1 080,00	<b>CB 600X350 H1+C2+DE</b>	1 080,00
CB 315 F2+DE	970,00	<b>CB 600X350 H1+C4+DE</b>	1 740,00
CB 315 F4+DE	1 080,00	<b>CB 600X350 H1+F4+DE</b>	1 930,00
CB 315 H1	560,00	<b>CB 600X350 H2</b>	970,00
CB 315 H1+C2+DE	1 160,00	<b>CB 600X350 H2+C2+DE</b>	1 580,00
CB 315 H1+C4+DE	1 290,00	<b>CB 600X350 H2+C4+DE</b>	1 890,00
CB 315 H1+F2+DE	1 160,00	<b>CB 600x350+H2+F4+DE</b>	2 120,00
CB 315 H1+F4+DE	1 290,00	<b>CB 700X400 C2+DE</b>	1 430,00
CB 315 H2	640,00	<b>CB 700X400 C4+DE</b>	1 770,00
CB 315 H2+C2+DE	1 240,00	<b>CB 700X400 F2+DE</b>	1 430,00
CB 315 H2+C4+DE	1 370,00	<b>CB 700X400 F4+DE</b>	1 850,00
CB 315 H2+F2+DE	1 240,00	<b>CB 700X400 H1</b>	830,00
CB 315 H2+F4+DE	1 370,00	<b>CB 700X400 H1+C2+DE</b>	1 700,00

Ceny przeliczone na PLN w dniu sprzedaży wg kursów średnich NBP.



Moduł chłodniczo-grzewczy		COMFORT BOX	
Typ • Type	Cena [EUR/szt.] • Price [EUR/pc]	Typ • Type	Cena [EUR/szt.] • Price [EUR/pc]
<b>CB 700X400 H1+C4+DE</b>	2 040,00	<b>CB 800X500 F4+DE</b>	2 700,00
<b>CB 700X400 H1+F2+DE</b>	1 740,00	<b>CB 800X500 H1</b>	1 200,00
<b>CB 700X400 H1+F4+DE</b>	2 120,00	<b>CB 800X500 H1+C2+DE</b>	2 040,00
<b>CB 700X400 H2</b>	1 010,00	<b>CB 800X500 H1+C4+DE</b>	2 470,00
<b>CB 700X400 H2+C2+DE</b>	1 850,00	<b>CB 800X500 H1+F4+DE</b>	2 780,00
<b>CB 700X400 H2+C4+DE</b>	2 200,00	<b>CB 800X500 H2</b>	1 310,00
<b>CB 700X400 H2+F2+DE</b>	1 850,00	<b>CB 800X500 H2+C2+DE</b>	2 200,00
<b>CB 700X400 H2+F4+DE</b>	2 240,00	<b>CB 800X500 H2+C4+DE</b>	2 700,00
<b>CB 800X500 C2+DE</b>	1 660,00	<b>CB 800X500 H2+F4+DE</b>	2 890,00
<b>CB 800X500 C4+DE</b>	2 040,00		

**C2** - wkład chłodnicy wodnej 2-rzędowy  
**C4** - wkład chłodnicy wodnej 4-rzędowy  
**H1** - wkład nagrzewnicy wodnej 1-rzędowy  
**H2** - wkład nagrzewnicy wodnej 2-rzędowy

**F2** - wkład chłodnicy freonowej 2-rzędowy  
**F4** - wkład chłodnicy freonowej 4-rzędowy  
**DE** - odkraplacz

Daszek • Roof	
Typ • Type	Cena [EUR/szt.] • Price [EUR/pc]
dla • for: <b>RIS 1200 H EKO</b>	160,00
dla • for: <b>RIS 1900/2200 H EKO</b>	170,00
dla • for: <b>RIS 2500 H EKO</b>	190,00
dla • for: <b>RIS 3500 H EKO</b>	200,00
dla • for: <b>RIRS 1200/1900 H EKO</b>	90,00
dla • for: <b>RIRS 2500 H EKO</b>	120,00
dla • for: <b>RIRS 3500 H EKO</b>	160,00
dla • for: <b>RIRS 5500 H EKO</b>	190,00

Nóżki • Support	
Typ • Type	Cena [EUR/szt.] • Price [EUR/pc]
dla • for: <b>Smarty 2X P</b>	40,00
dla • for: <b>Smarty 2X/3X/4X V</b>	40,00
dla • for: <b>Smarty 3X/4X P</b>	40,00

Ceny przeliczane na PLN w dniu sprzedaży wg kursów średnich NBP.

**Filtry do central wentylacyjnych • Filters for air handling units**
**FMK**

Typ • Type	Cena [EUR/szt.] • Price [EUR/pc]
<b>FMK 100/Coarse-75</b>	10,00
<b>FMK 100/ePM10-65</b>	10,00
<b>FMK 100/ePM1-55</b>	20,00
<b>FMK 125/Coarse-75</b>	10,00
<b>FMK 125/ePM10-65</b>	10,00
<b>FMK 125/ePM1-55</b>	20,00
<b>FMK 160/Coarse-75</b>	10,00
<b>FMK 160/ePM10-65</b>	10,00
<b>FMK 160/ePM1-55</b>	20,00
<b>FMK 200/Coarse-75</b>	10,00
<b>FMK 200/ePM10-65</b>	20,00
<b>FMK 200/ePM1-55</b>	20,00
<b>FMK 250/Coarse-75</b>	20,00
<b>FMK 250/ePM10-65</b>	20,00
<b>FMK 250/ePM1-55</b>	20,00
<b>FMK 315/Coarse-75</b>	20,00
<b>FMK 315/ePM10-65</b>	30,00
<b>FMK 315/ePM1-55</b>	40,00
<b>FMK 355/Coarse-75</b>	30,00
<b>FMK 355/ePM10-65</b>	30,00
<b>FMK 355/ePM1-55</b>	40,00
<b>FMK 400/Coarse-75</b>	30,00
<b>FMK 400/ePM10-65</b>	40,00
<b>FMK 400/ePM1-55</b>	50,00
<b>FMK 500/Coarse-75</b>	30,00
<b>FMK 500/ePM10-65</b>	40,00
<b>FMK 500/ePM1-55</b>	70,00

Typ • Type	Cena [EUR/szt.] • Price [EUR/pc]
<b>FMK 630/Coarse-75</b>	50,00
<b>FMK 630/ePM10-65</b>	60,00
<b>FMK 630/ePM1-55</b>	120,00
<b>FMK 40-20/Coarse-75</b>	30,00
<b>FMK 40-20/ePM10-65</b>	40,00
<b>FMK 40-20/ePM1-55</b>	50,00
<b>FMK 50-25/Coarse-75</b>	20,00
<b>FMK 50-25/ePM10-65</b>	20,00
<b>FMK 50-25/ePM1-55</b>	30,00
<b>FMK 50-30/Coarse-75</b>	20,00
<b>FMK 50-30/ePM10-65</b>	20,00
<b>FMK 50-30/ePM1-55</b>	30,00
<b>FMK 60-30/Coarse-75</b>	20,00
<b>FMK 60-30/ePM10-65</b>	20,00
<b>FMK 60-30/ePM1-55</b>	30,00
<b>FMK 60-35/Coarse-75</b>	20,00
<b>FMK 60-35/ePM10-65</b>	20,00
<b>FMK 60-35/ePM1-55</b>	40,00
<b>FMK 70-40/Coarse-75</b>	30,00
<b>FMK 70-40/ePM10-65</b>	30,00
<b>FMK 70-40/ePM1-55</b>	70,00
<b>FMK 80-50/Coarse-75</b>	40,00
<b>FMK 80-50/ePM10-65</b>	50,00
<b>FMK 80-50/ePM1-55</b>	100,00
<b>FMK 100-50/Coarse-75</b>	40,00
<b>FMK 100-50/ePM10-65</b>	50,00
<b>FMK 100-50/ePM1-55</b>	130,00

Ceny przeliczane na PLN w dniu sprzedaży wg kursów średnich NBP.



## FDI

Typ • Type	Cena [EUR/szt.] • Price [EUR/pc]
FDI 100/Coarse-75	50,00
FDI 100/ePM10-65	50,00
FDI 100/ePM1-55	50,00
FDI 125/Coarse-75	50,00
FDI 125/ePM10-65	50,00
FDI 125/ePM1-55	60,00
FDI 160/Coarse-75	60,00
FDI 160/ePM10-65	60,00
FDI 160/ePM1-55	60,00
FDI 200/Coarse-75	60,00
FDI 200/ePM10-65	60,00
FDI 200/ePM1-55	70,00
FDI 250/Coarse-75	60,00
FDI 250/ePM10-65	70,00
FDI 250/ePM1-55	70,00

Typ • Type	Cena [EUR/szt.] • Price [EUR/pc]
FDI 315/Coarse-75	80,00
FDI 315/ePM10-65	80,00
FDI 315/ePM1-55	80,00
FDI 355/Coarse-75	80,00
FDI 355/ePM10-65	90,00
FDI 355/ePM1-55	90,00
FDI 400/Coarse-75	90,00
FDI 400/ePM10-65	90,00
FDI 400/ePM1-55	90,00
FDI 500/Coarse-75	100,00
FDI 500/ePM10-65	100,00
FDI 500/ePM1-55	110,00
FDI 630/Coarse-75	150,00
FDI 630/ePM10-65	150,00
FDI 630/ePM1-55	160,00

## FD

Typ • Type	Cena [EUR/szt.] • Price [EUR/pc]
FD 100/Coarse-75	30,00
FD 125/Coarse-75	40,00
FD 160/Coarse-75	40,00
FD 200/Coarse-75	40,00
FD 250/Coarse-75	40,00
FD 315/Coarse-75	40,00
FD 355/Coarse-75	50,00
FD 400/Coarse-75	50,00
FD 500/Coarse-75	50,00
FD 630/Coarse-75	70,00

## FM

Typ • Type	Cena [EUR/szt.] • Price [EUR/pc]
FM 100-125-160/Coarse-75	10,00
FM 200/Coarse-75	10,00
FM 250/Coarse-75	10,00
FM 315/Coarse-75	10,00
FM 355/Coarse-75	10,00
FM 400/Coarse-75	10,00
FM 500/Coarse-75	10,00
FM 630/Coarse-75	20,00

Ceny przeliczane na PLN w dniu sprzedaży wg kursów średnich NBP.





### Centrale wentylacyjne Vent-Axia KINETIC ADVANCE

• Vent-Axia KINETIC ADVANCE air handling units

- wydajność: 350 m<sup>3</sup>/h (domy do 180 m<sup>2</sup>)
- wymiennik przeciwprądowy (odzysk ciepła do 94%)
- oszczędne silniki prądu stałego EBM PAPST
- sterownik z ekranem dotykowym na obudowie
- kontrola przez Wi-Fi i aplikację mobilną
- do wyboru filtry klasy G3, M5 lub F7
- kompaktowe wymiary

- efficiency: 350 m<sup>3</sup>/h (houses up to 180 m<sup>2</sup>)
- counter-current exchanger (heat recovery up to 94%)
- advanced EBM PAPST EC fans
- touch screen controller on casing
- Wi-Fi control with mobile app
- G3, M5 and F7 filter options
- lightweight and compact size

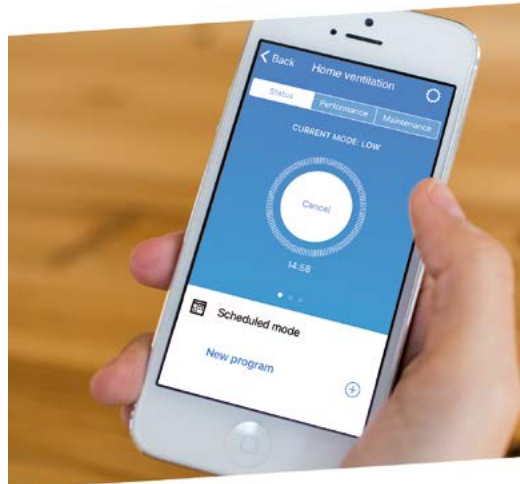

Model	Wydajność/spręż <sup>1)</sup> • Efficiency/Compression range [m <sup>3</sup> /h] / [Pa]	Wymiary <sup>2)</sup> • Unit size [mm]	Przyłącze • Connection [mm]	Zasilanie • Supply voltage [V/Hz]	Cena [EUR/szt.] • Price [EUR/pc]
<b>Kinetic Advance S</b>	370 / 100	660×760×443	125	230/50	1 790,00

<sup>1)</sup> wartości mierzone w punkcie pracy • value at the working point

<sup>2)</sup> szerokość × wysokość × długość • width × height × length

Ceny przeliczane na PLN w dniu sprzedaży wg kursów średnich NBP.

**Centrale wentylacyjne Vent-Axia KINETIC (PLUS) • Vent-Axia KINETIC (PLUS) air handling units**

- wymiennik krzyżowy przeciwprądowy - **ODZYSK do 92%**
- wydajności: Kinetic - 250 m<sup>3</sup>/h, Kinetic Plus - 400 m<sup>3</sup>/h
- nisko-energetyczne silniki prądu stałego EC/DC
- łatwa wymiana filtrów bez konieczności zdejmowania panelu przedniego
- możliwość zmiany kierunku otworów przyłączeniowych: wersja pionowa/pozioma
- zdolność do podłączenia BMS
- regulowany opóźnieniowy włącznik/wyłącznik czasowy
- counterflow plate heat exchanger - *RECUPERATION* to 92%
- efficiency: Kinetic - 250 m<sup>3</sup>/h, Kinetic Plus - 400 m<sup>3</sup>/h
- low energy EC/DC motors
- easy to change filters, without removing the front panel
- horizontal and/or vertical duct outlets
- BMS connectivity
- adjustable delay on/delay off timer



Kinetic B



Kinetic B Plus

Model	Wydajność/spręż <sup>1)</sup> • Efficiency/Compression range [m <sup>3</sup> /h] / [Pa]	Wymiary <sup>2)</sup> • Unit size [mm]	Przyłącze • Connection [mm]	Zasilanie • Supply voltage [V/Hz]	Cena [EUR/szt.] • Price [EUR/pc]
<b>Kinetic B</b>	250/90	550×650×285	125	230/50	1 230,00
<b>Kinetic B Plus</b>	400/150	785×747×526	150	230/50	1 720,00

<sup>1)</sup> wartości mierzone w punkcie pracy • value at the working point

<sup>2)</sup> szerokość × wysokość × długość • width × height × length

Ceny przeliczone na PLN w dniu sprzedaży wg kursów średnich NBP.



## Nagrzewnica wodna • Water heater

### AVS



Typ • Type	Cena [EUR/szt.] • Price [EUR/pc]
<b>AVS 100</b>	160,00
<b>AVS 125</b>	160,00
<b>AVS 160</b>	200,00
<b>AVS 200</b>	210,00

Typ • Type	Cena [EUR/szt.] • Price [EUR/pc]
<b>AVS 250</b>	260,00
<b>AVS 315</b>	330,00
<b>AVS 400</b>	410,00
<b>AVS 500</b>	480,00

## Nagrzewnica wodna kanałowa prostokątna • Heating coil for rectangular ducting

### SVS

Typ • Type	Cena [EUR/szt.] • Price [EUR/pc]
<b>SVS 400x200-2</b>	200,00
<b>SVS 400x200-4</b>	270,00
<b>SVS 500x250-2</b>	250,00
<b>SVS 500x250-4</b>	350,00
<b>SVS 500x300-2</b>	280,00
<b>SVS 500x300-4</b>	380,00
<b>SVS 600x300-2</b>	300,00
<b>SVS 600x300-4</b>	440,00
<b>SVS 600x350-2</b>	320,00
<b>SVS 600x350-4</b>	450,00

Typ • Type	Cena [EUR/szt.] • Price [EUR/pc]
<b>SVS 700x400-2</b>	380,00
<b>SVS 700x400-4</b>	560,00
<b>SVS 800x500-2</b>	500,00
<b>SVS 800x500-4</b>	760,00
<b>SVS 1000x500-2</b>	560,00
<b>SVS 1000x500-4</b>	920,00
<b>SVS-V 500x250-2</b>	310,00
<b>SVS-V 600x300-2</b>	340,00
<b>SVS-V 900x300-2</b>	400,00

## Chłodnica wodna • Water cooler

### AVA



Typ • Type	Cena [EUR/szt.] • Price [EUR/pc]
<b>AVA 100</b>	260,00
<b>AVA 125</b>	260,00
<b>AVA 160</b>	270,00
<b>AVA 200</b>	330,00
<b>AVA 250</b>	400,00

Typ • Type	Cena [EUR/szt.] • Price [EUR/pc]
<b>AVA 315</b>	480,00
<b>AVA 400</b>	610,00
<b>AVA 500</b>	1 200,00
<b>AVA 630</b>	1 700,00
<b>AVA 710</b>	2 430,00

Ceny przeliczane na PLN w dniu sprzedaży wg kursów średnich NBP.



Chłodnica wodna prostokątna • Water cooler for rectangular ducting		SVA	
Typ • Type	Cena [EUR/szt.] • Price [EUR/pc]	Typ • Type	Cena [EUR/szt.] • Price [EUR/pc]
<b>SVA 500x250-2</b>	500,00	<b>SVA 600x350-2</b>	700,00
<b>SVA 500x250-4</b>	620,00	<b>SVA 600x350-4</b>	900,00
<b>SVA 600x300-2</b>	630,00	<b>SVA 700x400-2</b>	910,00
<b>SVA 600x300-4</b>	810,00	<b>SVA 700x400-4</b>	1 150,00

Chłodnica freonowa okrągła • Freon cooler		AVA-DX	
Typ • Type	Cena [EUR/szt.] • Price [EUR/pc]	Typ • Type	Cena [EUR/szt.] • Price [EUR/pc]
<b>AVA-DX 315</b>	680,00	<b>AVA-DX 315</b>	680,00
<b>AVA-DX 400</b>	740,00	<b>AVA-DX 400</b>	740,00
<b>AVA-DX 500</b>	1 060,00	<b>AVA-DX 500</b>	1 060,00
<b>AVA-DX 630</b>	1 640,00	<b>AVA-DX 630</b>	1 640,00
<b>AVA-DX 710</b>	2 890,00	<b>AVA-DX 710</b>	2 890,00



Chłodnica freonowa prostokątna / okrągła • Freon cooler		SVF	
Typ • Type	Cena [EUR/szt.] • Price [EUR/pc]	Typ • Type	Cena [EUR/szt.] • Price [EUR/pc]
<b>SVF 400x200</b>	500,00	<b>SVF 600x350</b>	850,00
<b>SVF 500x250</b>	600,00	<b>SVF 700x400</b>	1 110,00
<b>SVF 500x300</b>	700,00	<b>SVF 800x500</b>	1 390,00
<b>SVF 600x300</b>	750,00	<b>SVF 1000x500</b>	1 540,00



Ceny przeliczane na PLN w dniu sprzedaży wg kursów średnich NBP.



## Nagrzewnica kanałowa elektryczna • Electrical duct heater

## EKA

Typ • Type	Cena [EUR/szt.] • Price [EUR/pc]
EKA 100-0.3-1f	60,00
EKA 100-0.6-1f	60,00
EKA 100-0.9-1f	80,00
EKA 100-1.2-1f	90,00
EKA 100-1.5 1f	100,00
EKA 100-1.8 1f	110,00
EKA 125-0.3-1f	60,00
EKA 125-0.6-1f	70,00
EKA 125-0.9-1f	80,00
EKA 125-1.2-1f	90,00
EKA 125-1.5 1f	100,00
EKA 125-1.8-1f	110,00
EKA 125-2.4-1f	110,00
EKA 125-3.0-1f	110,00
EKA 160-0.3-1f	70,00
EKA 160-0.6-1f	70,00
EKA 160-0.9-1f	80,00
EKA 160-1.0-1f	70,00
EKA 160-1.2-1f	80,00
EKA 160-1.8-1f	80,00
EKA 160-2.0-1f	80,00
EKA 160-2.4-1f	80,00
EKA 160-3.0-1f	90,00
EKA 160-3.0-2f	90,00
EKA 160-5.0-1f	120,00
EKA 160-5.0-2f	120,00
EKA 160-6.0-2f	130,00
EKA 200-0.3-1f	70,00
EKA 200-0.6-1f	80,00
EKA 200-0.9-1f	100,00

Typ • Type	Cena [EUR/szt.] • Price [EUR/pc]
EKA 200-1.2-1f	80,00
EKA 200-2.0-1f	90,00
EKA 200-2.4-1f	100,00
EKA 200-3.0-1f	100,00
EKA 200-3.0-2f	110,00
EKA 200-5.0-1f	140,00
EKA 200-5.0-2f	130,00
EKA 200-6.0-1f	140,00
EKA 200-6.0-2f	150,00
EKA 200-6.0-3f	150,00
EKA 250-0.3-1f	70,00
EKA 250-0.6-1f	90,00
EKA 250-0.9-1f	100,00
EKA 250-1.0-1f	80,00
EKA 250-1.2-1f	80,00
EKA 250-1.5-1f	90,00
EKA 250-2.0-1f	90,00
EKA 250-2.4-1f	100,00
EKA 250-3.0-1f	100,00
EKA 250-3.0-2f	110,00
EKA 250-3.0-3f	110,00
EKA 250-5.0-1f	140,00
EKA 250-5.0-2f	130,00
EKA 250-6.0-1f	150,00
EKA 250-6.0-2f	110,00
EKA 250-6.0-3f	150,00
EKA 250-9.0-3f	130,00
EKA 315-0.6-1f	100,00
EKA 315-1.0-1f	100,00
EKA 315-1.2-1f	100,00
EKA 315-1.5-1f	110,00

Typ • Type	Cena [EUR/szt.] • Price [EUR/pc]
EKA 315-1.8-1f	130,00
EKA 315-2.0-1f	110,00
EKA 315-2.4-1f	120,00
EKA 315-3.0-1f	130,00
EKA 315-3.0-2f	120,00
EKA 315-4.5-1f	160,00
EKA 315-5.0-1f	160,00
EKA 315-5.0-2f	160,00
EKA 315-6.0-2f	160,00
EKA 315-6.0-3f	180,00
EKA 315-9.0-3f	190,00
EKA 315-12.0-3f	240,00
EKA 315-15.0-3f	290,00
EKA 315-18.0-3f	300,00
EKA 355-6.0-3f	180,00
EKA 355-9.0-3f	190,00
EKA 355-12.0-3f	250,00
EKA 355-15.0-3f	290,00
EKA 400-3.0-1f	140,00
EKA 400-3.0-2f	130,00
EKA 400-3.0-3f	130,00
EKA 400-5.0-1f	170,00
EKA 400-5.0-2f	160,00
EKA 400-6.0-2f	160,00
EKA 400-6.0-3f	180,00
EKA 400-9.0-3f	200,00
EKA 400-12.0-3f	250,00
EKA 400-15.0-3f	300,00
EKA 400-18.0-3f	320,00
EKA 400-24.0-3f	410,00

Ceny przeliczone na PLN w dniu sprzedaży wg kursów średnich NBP.



## Nagrzewnica kanałowa elektryczna • *Electrical duct heater*

## EKA NV PTC/PS

Nagrzewnica EKA NV z zabudowanym presostatem na obudowie.

Typ • <i>Type</i>	Cena • <i>Price</i> [EUR/szt. • <i>pc</i> ]
EKA NV PTC/PS 100-0.3-1f	240,00
EKA NV PTC/PS 100-0.6-1f	250,00
EKA NV PTC/PS 100-0.9-1f	270,00
EKA NV PTC/PS 100-1.2-1f	290,00
EKA NV PTC/PS 125-0.6-1f	260,00
EKA NV PTC/PS 125-0.9-1f	280,00
EKA NV PTC/PS 125-1.2-1f	290,00
EKA NV PTC/PS 125-1.5-1f	290,00
EKA NV PTC/PS 125-1.8-1f	310,00
EKA NV PTC/PS 125-2.4-1f	310,00
EKA NV PTC/PS 160-0.9-1f	280,00
EKA NV PTC/PS 160-1.2-1f	250,00
EKA NV PTC/PS 160-1.5-1f	260,00
EKA NV PTC/PS 160-1.6-1f	280,00
EKA NV PTC/PS 160-2.0-1f	290,00
EKA NV PTC/PS 160-2.4-1f	290,00
EKA NV PTC/PS 160-3.0-1f	300,00
EKA NV PTC/PS 160-3.0-3f	310,00
EKA NV PTC/PS 160-5.0-2f	340,00
EKA NV PTC/PS 160-6.0-2f	360,00
EKA NV PTC/PS 200-0.9-1f	300,00
EKA NV PTC/PS 200-1.2-1f	270,00
EKA NV PTC/PS 200-1.6-1f	240,00
EKA NV PTC/PS 200-2.0-1f	250,00
EKA NV PTC/PS 200-3.0-1f	270,00
EKA NV PTC/PS 200-5.0-2f	290,00
EKA NV PTC/PS 200-6.0-2f	300,00
EKA NV PTC/PS 200-6.0-3f	330,00
EKA NV PTC/PS 250-1.2-1f	220,00
EKA NV PTC/PS 250-1.5-1f	240,00

Typ • <i>Type</i>	Cena • <i>Price</i> [EUR/szt. • <i>pc</i> ]
EKA NV PTC/PS 250-2.0-1f	250,00
EKA NV PTC/PS 250-3.0-1f	270,00
EKA NV PTC/PS 250-3.0-2f	280,00
EKA NV PTC/PS 250-3.0-3f	280,00
EKA NV PTC/PS 250-3.6-1f	290,00
EKA NV PTC/PS 250-5.0-1f	300,00
EKA NV PTC/PS 250-5.0-2f	300,00
EKA NV PTC/PS 250-6.0-2f	300,00
EKA NV PTC/PS 250-6.0-3f	330,00
EKA NV PTC/PS 250-9.0-3f	350,00
EKA NV PTC/PS 315-1.5-1f	250,00
EKA NV PTC/PS 315-2.0-1f	260,00
EKA NV PTC/PS 315-3.0-1f	280,00
EKA NV PTC/PS 315-3.0-2f	290,00
EKA NV PTC/PS 315-5.0-2f	300,00
EKA NV PTC/PS 315-6.0-2f	310,00
EKA NV PTC/PS 315-6.0-3f	350,00
EKA NV PTC/PS 315-9.0-3f	370,00
EKA NV PTC/PS 315-12.0-3f	450,00
EKA NV PTC/PS 315-15.0-3f	470,00
EKA NV PTC/PS 400-3.0-1f	260,00
EKA NV PTC/PS 400-3.0-2f	290,00
EKA NV PTC/PS 400-5.0-2f	310,00
EKA NV PTC/PS 400-6.0-2f	320,00
EKA NV PTC/PS 400-6.0-3f	350,00
EKA NV PTC/PS 400-9.0-3f	390,00
EKA NV PTC/PS 400-12.0-3f	420,00
EKA NV PTC/PS 400-15.0-3f	510,00
EKA NV PTC/PS 400-18.0-3f	600,00

Ceny przeliczane na PLN w dniu sprzedaży wg kursów średnich NBP.



## Nagrzewnica kanałowa elektryczna • Electrical duct heater

## EKA NIS

Nagrzewnica z zabudowanym układem regulacyjnym przystosowana do sterowania sygnałem 0...10V.

Typ • Type	Cena • Price [EUR/szt. • pc]
EKA NIS 100-0.3-1f	120,00
EKA NIS 100-0.6-1f	120,00
EKA NIS 100-0.9-1f	140,00
EKA NIS 100-1.2-1f	150,00
EKA NIS 125-0.3-1f	120,00
EKA NIS 125-0.6-1f	140,00
EKA NIS 125-0.9-1f	140,00
EKA NIS 125-1.2-1f	160,00
EKA NIS 125-1.8-1f	160,00
EKA NIS 125-2.4-1f	170,00
EKA NIS 160-0.3-1f	130,00
EKA NIS 160-0.6-1f	130,00
EKA NIS 160-0.9-1f	150,00
EKA NIS 160-1.0-1f	120,00
EKA NIS 160-1.2-1f	120,00
EKA NIS 160-1.8-1f	140,00
EKA NIS 160-2.0-1f	150,00
EKA NIS 160-2.4-1f	160,00
EKA NIS 160-3.0-2f	180,00
EKA NIS 160-5.0-2f	190,00
EKA NIS 160-6.0-2f	210,00
EKA NIS 160-6.0-3f	240,00
EKA NIS 200-0.9-1f	160,00
EKA NIS 200-1.2-1f	140,00

Typ • Type	Cena • Price [EUR/szt. • pc]
EKA NIS 200-1.5-1f	150,00
EKA NIS 200-2.0-1f	170,00
EKA NIS 200-2.4-1f	170,00
EKA NIS 200-2.7-1f	210,00
EKA NIS 200-3.0-1f	180,00
EKA NIS 200-3.0-2f	190,00
EKA NIS 200-5.0-2f	210,00
EKA NIS 200-6.0-2f	240,00
EKA NIS 200-6.0-3f	250,00
EKA NIS 250-0.6-1f	140,00
EKA NIS 250-1.0-1f	140,00
EKA NIS 250-1.2-1f	150,00
EKA NIS 250-1.3-1f	150,00
EKA NIS 250-1.5-1f	160,00
EKA NIS 250-2.0-1f	170,00
EKA NIS 250-2.4-1f	180,00
EKA NIS 250-3.0-1f	180,00
EKA NIS 250-3.0-2f	190,00
EKA NIS 250-3.0-3f	190,00
EKA NIS 250-5.0-2f	200,00
EKA NIS 250-6.0-2f	220,00
EKA NIS 250-6.0-3f	260,00
EKA NIS 250-9.0-3f	270,00
EKA NIS 250-12.0-3f	350,00

Typ • Type	Cena • Price [EUR/szt. • pc]
EKA NIS 315-1.0-1f	160,00
EKA NIS 315-1.2-1f	170,00
EKA NIS 315-2.0-1f	180,00
EKA NIS 315-2.4-1f	210,00
EKA NIS 315-2.6-1f	220,00
EKA NIS 315-3.0-1f	220,00
EKA NIS 315-5.0-2f	240,00
EKA NIS 315-6.0-2f	250,00
EKA NIS 315-6.0-3f	270,00
EKA NIS 315-9.0-3f	290,00
EKA NIS 315-12.0-3f	340,00
EKA NIS 400-3.0-1f	220,00
EKA NIS 400-3.0-2f	220,00
EKA NIS 400-5.0-2f	260,00
EKA NIS 400-6.0-1f	280,00
EKA NIS 400-3.0-2f	200,00
EKA NIS 400-5.0-2f	230,00
EKA NIS 400-6.0-2f	230,00
EKA NIS 400-6.0-3f	270,00
EKA NIS 400-9.0-3f	310,00
EKA NIS 400-12.0-3f	360,00
EKA NIS 400-15.0-3f	400,00
EKA NIS 400-18.0-3f	480,00

## Regulatory i czujki temp. do nagrzewnic • Controllers and temperature sensors for electrical heating

EKR 6.1	EKR 15.1	EKR 15.1P	TJK-10K	TR5K
Cena [EUR/szt.] • Price [EUR/pc]				
110,00	300,00	400,00	20,00	30,00

Ceny przeliczone na PLN w dniu sprzedaży wg kursów średnich NBP.



## Nagrzewnica kanałowa elektryczna prostokątna

• Rectangular electrical duct heater

EKS

Typ - Type	Cena [EUR/szt.] • Price [EUR/pc]
EKS 400x200/5 kW	240,00
EKS 400x200/6 kW	260,00
EKS 400x200/9 kW	270,00
EKS 400x200/12 kW	320,00
EKS 400x200/15 kW	370,00
EKS 400x200/21 kW	440,00
EKS 500x250/6kW	260,00
EKS 500x250/9kW	280,00
EKS 500x250/12 kW	330,00
EKS 500x250/15kW	380,00
EKS 500x250/21 kW	470,00
EKS 500x250/24 kW	530,00
EKS 500x250/27 kW	580,00
EKS 500x250/36 kW	640,00
EKS 500x250/45 kW	760,00
EKS 500x300/5kW	260,00
EKS 500x300/6kW	260,00
EKS 500x300/9kW	260,00
EKS 500x300/12kW	320,00
EKS 500x300/15kW	340,00
EKS 500x300/18kW	370,00
EKS 500x300/21kW	420,00
EKS 500x300/24kW	440,00
EKS 500x300/27 kW	530,00
EKS 500x300/30 kW	550,00
EKS 500x300/33 kW	580,00
EKS 500x300/36 kW	640,00
EKS 500x300/42 kW	690,00
EKS 500x300/45 kW	720,00

Typ - Type	Cena [EUR/szt.] • Price [EUR/pc]
EKS 600x300/9kW	270,00
EKS 600x300/12kW	330,00
EKS 600x300/15kW	350,00
EKS 600x300/18kW	380,00
EKS 600x300/21kW	430,00
EKS 600x300/24kW	450,00
EKS 600x300/27kW	520,00
EKS 600x300/30kW	540,00
EKS 600x300/33kW	570,00
EKS 600x300/36 kW	650,00
EKS 600x300/42 kW	690,00
EKS 600x300/45 kW	740,00
EKS 600x350/9kW	290,00
EKS 600x350/12kW	340,00
EKS 600x350/15kW	360,00
EKS 600x350/18kW	390,00
EKS 600x350/21kW	450,00
EKS 600x350/24kW	470,00
EKS 600x350/27kW	540,00
EKS 600x350/30kW	560,00
EKS 600x350/33 kW	590,00
EKS 600x350/36 kW	650,00
EKS 600x350/42 kW	760,00
EKS 600x350/45 kW	810,00
EKS 700x400/9 kW	300,00
EKS 700x400/12kW	390,00
EKS 700x400/15kW	400,00
EKS 700x400/18kW	410,00
EKS 700x400/21kW	470,00

Ceny przeliczane na PLN w dniu sprzedaży wg kursów średnich NBP.





## Nagrzewnica kanałowa elektryczna prostokątna

• Rectangular electrical duct heater

EKS

Typ - Type	Cena [EUR/szt.] • Price [EUR/pc]
EKS 700x400/24kW	490,00
EKS 700x400/27kW	550,00
EKS 700x400/30kW	580,00
EKS 700x400/33kW	600,00
EKS 700x400/36kW	660,00
EKS 700x400/42 kW	730,00
EKS 700x400/45 kW	770,00
EKS 700x400/51 kW	880,00
EKS 700x400/60 kW	990,00
EKS 700x400/66 kW	1 030,00
EKS 700x400/75 kW	1 180,00
EKS 700x400/90 kW	1 430,00
EKS 800x500/9 kW	320,00
EKS 800x500/12 kW	380,00
EKS 800x500/15 kW	400,00
EKS 800x500/18 kW	430,00
EKS 800x500/21 kW	480,00
EKS 800x500/24 kW	510,00
EKS 800x500/27 kW	560,00
EKS 800x500/30 kW	590,00
EKS 800x500/33 kW	600,00
EKS 800x500/36 kW	670,00
EKS 800x500/39 kW	710,00
EKS 800x500/42 kW	730,00
EKS 800x500/45 kW	770,00
EKS 800x500/51 kW	830,00

Typ - Type	Cena [EUR/szt.] • Price [EUR/pc]
EKS 800x500/54 kW	890,00
EKS 800x500/60 kW	1 000,00
EKS 800x500/63 kW	1 040,00
EKS 800x500/66 kW	1 110,00
EKS 800x500/75 kW	1 210,00
EKS 800x500/90 kW	1 450,00
EKS 1000x500/9 kW	360,00
EKS 1000x500/12 kW	370,00
EKS 1000x500/15 kW	380,00
EKS 1000x500/18 kW	400,00
EKS 1000x500/24 kW	460,00
EKS 1000x500/27 kW	520,00
EKS 1000x500/30 kW	620,00
EKS 1000x500/33 kW	650,00
EKS 1000x500/36 kW	700,00
EKS 1000x500/39 kW	720,00
EKS 1000x500/42 kW	750,00
EKS 1000x500/45 kW	810,00
EKS 1000x500/51 kW	910,00
EKS 1000x500/54 kW	930,00
EKS 1000x500/60 kW	1 030,00
EKS 1000x500/66 kW	1 070,00
EKS 1000x500/75 kW	1 230,00
EKS 1000x500/90 kW	1 510,00

Ceny przeliczane na PLN w dniu sprzedaży wg kursów średnich NBP.



## Nagrzewnica kanałowa elektryczna prostokątna

• *Rectangular electrical duct heater*

## EKS NV PTC/PS

Nagrzewnica EKS z okablowaną automatyką i presostatem.

Typ • <i>Type</i>	Cena [EUR/szt.] • <i>Price [EUR/pc]</i>
EKS NV PTC/PS 400x200/6 kW	410,00
EKS NV PTC/PS 400x200/9 kW	420,00
EKS NV PTC/PS 400x200/12 kW	460,00
EKS NV PTC/PS 400x200/15 kW	500,00
EKS NV PTC/PS 400x200/21 kW	570,00
EKS NV PTC/PS 500x250/3kW	390,00
EKS NV PTC/PS 500x250/6kW	400,00
EKS NV PTC/PS 500x250/9kW	420,00
EKS NV PTC/PS 500x250/12 kW	460,00
EKS NV PTC/PS 500x250/15kW	520,00
EKS NV PTC/PS 500x250/21 kW	610,00
EKS NV PTC/PS 500x250/24 kW	660,00
EKS NV PTC/PS 500x250/36 kW	820,00
EKS NV PTC/PS 500x250/45 kW	950,00
EKS NV PTC/PS 500x300/6kW	400,00
EKS NV PTC/PS 500x300/9kW	410,00
EKS NV PTC/PS 500x300/12kW	460,00
EKS NV PTC/PS 500x300/15kW	470,00
EKS NV PTC/PS 500x300/18kW	500,00
EKS NV PTC/PS 500x300/21kW	550,00
EKS NV PTC/PS 500x300/24kW	580,00
EKS NV PTC/PS 500x300/27 kW	660,00
EKS NV PTC/PS 500x300/30 kW	690,00
EKS NV PTC/PS 500x300/33 kW	690,00
EKS NV PTC/PS 500x300/36 kW	750,00
EKS NV PTC/PS 500x300/42 kW	800,00
EKS NV PTC/PS 500x300/45 kW	850,00
EKS NV PTC/PS 600x300/6kW	400,00
EKS NV PTC/PS 600x300/9kW	400,00

Typ • <i>Type</i>	Cena [EUR/szt.] • <i>Price [EUR/pc]</i>
EKS NV PTC/PS 600x300/12kW	450,00
EKS NV PTC/PS 600x300/15kW	480,00
EKS NV PTC/PS 600x300/18kW	510,00
EKS NV PTC/PS 600x300/21kW	560,00
EKS NV PTC/PS 600x300/24kW	580,00
EKS NV PTC/PS 600x300/27kW	640,00
EKS NV PTC/PS 600x300/30kW	670,00
EKS NV PTC/PS 600x300/33kW	700,00
EKS NV PTC/PS 600x300/36 kW	770,00
EKS NV PTC/PS 600x300/42 kW	850,00
EKS NV PTC/PS 600x300/45 kW	900,00
EKS NV PTC/PS 600x350/6kW	410,00
EKS NV PTC/PS 600x350/9kW	410,00
EKS NV PTC/PS 600x350/12kW	470,00
EKS NV PTC/PS 600x350/15kW	480,00
EKS NV PTC/PS 600x350/18kW	510,00
EKS NV PTC/PS 600x350/21kW	560,00
EKS NV PTC/PS 600x350/24kW	590,00
EKS NV PTC/PS 600x350/27kW	650,00
EKS NV PTC/PS 600x350/30kW	680,00
EKS NV PTC/PS 600x350/33 kW	720,00
EKS NV PTC/PS 600x350/36 kW	770,00
EKS NV PTC/PS 600x350/42 kW	830,00
EKS NV PTC/PS 600x350/45 kW	890,00
EKS NV PTC/PS 700x300/5 kW	400,00
EKS NV PTC/PS 700x400/6 kW	420,00
EKS NV PTC/PS 700x400/9 kW	460,00
EKS NV PTC/PS 700x400/12kW	480,00
EKS NV PTC/PS 700x400/15 kW	500,00

Ceny przeliczane na PLN w dniu sprzedaży wg kursów średnich NBP.



Nagrzewnica kanałowa elektryczna prostokątna • <i>Rectangular electrical duct heater</i>		EKS NV PTC/PS	
Typ • <i>Type</i>	Cena [EUR/szt.] • <i>Price [EUR/pc]</i>	Typ • <i>Type</i>	Cena [EUR/szt.] • <i>Price [EUR/pc]</i>
EKS NV PTC/PS 700x400/18 kW	530,00	EKS NV PTC/PS 800x500/45 kW	920,00
EKS NV PTC/PS 700x400/21kW	590,00	EKS NV PTC/PS 800x500/51 kW	970,00
EKS NV PTC/PS 700x400/24kW	620,00	EKS NV PTC/PS 800x500/54 kW	1 030,00
EKS NV PTC/PS 700x400/27kW	680,00	EKS NV PTC/PS 800x500/60 kW	1 190,00
EKS NV PTC/PS 700x400/30kW	700,00	EKS NV PTC/PS 800x500/66 kW	1 230,00
EKS NV PTC/PS 700x400/33kW	740,00	EKS NV PTC/PS 1000x500/6 kW	480,00
EKS NV PTC/PS 700x400/36kW	770,00	EKS NV PTC/PS 1000x500/9 kW	490,00
EKS NV PTC/PS 700x400/42 kW	850,00	EKS NV PTC/PS 1000x500/12 kW	510,00
EKS NV PTC/PS 700x400/45 kW	900,00	EKS NV PTC/PS 1000x500/15 kW	540,00
EKS NV PTC/PS 700x400/51 kW	970,00	EKS NV PTC/PS 1000x500/18 kW	570,00
EKS NV PTC/PS 700x400/60 kW	1 080,00	EKS NV PTC/PS 1000x500/21 kW	620,00
EKS NV PTC/PS 700x400/66 kW	1 150,00	EKS NV PTC/PS 1000x500/24 kW	640,00
EKS NV PTC/PS 800x500/9 kW	440,00	EKS NV PTC/PS 1000x500/27 kW	700,00
EKS NV PTC/PS 800x500/12 kW	490,00	EKS NV PTC/PS 1000x500/30 kW	710,00
EKS NV PTC/PS 800x500/15 kW	520,00	EKS NV PTC/PS 1000x500/33 kW	730,00
EKS NV PTC/PS 800x500/18 kW	560,00	EKS NV PTC/PS 1000x500/36 kW	790,00
EKS NV PTC/PS 800x500/21 kW	610,00	EKS NV PTC/PS 1000x500/39 kW	810,00
EKS NV PTC/PS 800x500/24 kW	640,00	EKS NV PTC/PS 1000x500/42 kW	840,00
EKS NV PTC/PS 800x500/27 kW	700,00	EKS NV PTC/PS 1000x500/45 kW	900,00
EKS NV PTC/PS 800x500/30 kW	730,00	EKS NV PTC/PS 1000x500/51 kW	980,00
EKS NV PTC/PS 800x500/33 kW	760,00	EKS NV PTC/PS 1000x500/54 kW	1 030,00
EKS NV PTC/PS 800x500/36 kW	810,00	EKS NV PTC/PS 1000x500/60 kW	1 210,00
EKS NV PTC/PS 800x500/39 kW	830,00	EKS NV PTC/PS 1000x500/66 kW	1 250,00
EKS NV PTC/PS 800x500/42 kW	860,00		

Ceny przeliczane na PLN w dniu sprzedaży wg kursów średnich NBP.



## Nagrzewnica powietrza • Air heaters

## VOLCANO V



VR1



VR45

Nazwa • Name	Moc grzewcza • Heating power [kW]	Maks. wydajność powietrza • Max efficiency [m <sup>3</sup> /h]	Cena [PLN/szt.] • Price [PLN/pc]
<b>VOLCANO VR MINI EC</b>	3 - 20	2100	1 099,00
<b>VOLCANO VR1 EC</b>	5 - 30	5300	1 569,00
<b>VOLCANO VR2 EC</b>	8 - 50	4850	1 729,00
<b>VOLCANO VR3 EC</b>	13 - 75	5700	1 969,00
<b>VOLCANO VR-D EC</b>	-	6500	1 389,00

## Osprzęt do nagrzewnic powietrza • Accessories for air heaters

Typ • Type	Cena [PLN/szt.] • Price [PLN/pc]
Potencjometr VR EC (0-10 V)	99,00
Potencjometr z termostatem VR EC*	109,00
Sterownik Volcano EC	299,00
Czujnik pomieszczeniowy NTC (IP30)	62,00
Czujnik pomieszczeniowy NTC (IP66)*	62,00
Zawór z siłownikiem	207,00

\* sprawdź dostępność



## Nagrzewnica wodna • Water heater

## HEATER



Typ • Type	Moc • Power [kW]	Cena [PLN/szt.] • Price [PLN/pc]
<b>HEATER ONE</b>	5-20	999,00
<b>HEATER R1</b>	10-30	1 259,00
<b>HEATER R2</b>	30-50	1 399,00
<b>HEATER R3</b>	50-70	1 599,00
<b>HEATER MIX destryfikator</b>	-	1 249,00
<b>HEATER SPECIAL dla agro</b>	20-45	2 499,00

## Nagrzewnica gazowa • Gas heater

## RAPID



Typ • Type	Moc • Power [kW]	Cena [PLN/szt.] • Price [PLN/pc]
<b>Rapid LR015</b>	15 / 12	6 999,00
<b>Rapid LR024</b>	25 / 21	7 499,00
<b>Rapid LR034</b>	32 / 26	7 899,00
<b>Rapid LR042</b>	40 / 31	9 499,00
<b>Rapid LR052</b>	48 / 37	10 399,00
<b>Rapid LR072</b>	68 / 56	11 999,00
<b>Rapid LR102</b>	92 / 77	15 699,00



## Wentylator kanałowy • Duct fan

## VKAP 3.0



Praca w pomieszczeniu

Typ • Type	Cena [EUR/szt.] • Price [EUR/pc]
<b>VKAP 100 LD 3.0</b>	72,00
<b>VKAP 100 MD 3.0</b>	70,00
<b>VKAP 125 LD 3.0</b>	74,00
<b>VKAP 125 MD 3.0</b>	72,00
<b>VKAP 150 LD 3.0</b>	94,00
<b>VKAP 160 LD 3.0</b>	94,00
<b>VKAP 160 MD 3.0</b>	74,00

Typ • Type	Cena [EUR/szt.] • Price [EUR/pc]
<b>VKAP 200 LD 3.0</b>	117,00
<b>VKAP 200 MD 3.0</b>	94,00
<b>VKAP 250 LD 3.0</b>	123,00
<b>VKAP 250 MD 3.0</b>	96,00
<b>VKAP 315 LD 3.0</b>	149,00
<b>VKAP 315 MD 3.0</b>	145,00

## Wentylator kanałowy izolowany akustycznie

• Acoustically insulated duct fan

## AKU



Praca w pomieszczeniu

Typ • Type	Cena [EUR/szt.] • Price [EUR/pc]
<b>AKU 125 D</b>	200,00
<b>AKU 125 M</b>	190,00
<b>AKU 160 D</b>	230,00
<b>AKU 160 M</b>	200,00
<b>AKU 200 D</b>	260,00
<b>AKU 200 M</b>	260,00
<b>AKU 250 D</b>	490,00

Typ • Type	Cena [EUR/szt.] • Price [EUR/pc]
<b>AKU 250 M</b>	270,00
<b>AKU 250 S</b>	360,00
<b>AKU 315 D</b>	790,00
<b>AKU 315 M</b>	580,00
<b>AKU 400 D</b>	830,00
<b>AKU 400 S</b>	950,00

Pełna oferta wentylatorów SALDA - na zapytanie.

Ceny przeliczone na PLN w dniu sprzedaży wg kursów średnich NBP.



## Wentylator kanałowy izolowany akustycznie

• Acoustically insulated duct fan

## AKU EKO

EKO - silnik EC

Praca w pomieszczeniu



Typ • Type	Cena [EUR/szt.] • Price [EUR/pc]
<b>AKU 125 EKO</b>	250,00
<b>AKU 160 EKO</b>	320,00
<b>AKU 200 EKO</b>	370,00

Typ • Type	Cena [EUR/szt.] • Price [EUR/pc]
<b>AKU 250 EKO</b>	390,00
<b>AKU 315 EKO</b>	830,00

## Wentylator kanałowy • Duct fan

## VKA EKO

EKO - silnik EC

Praca w pomieszczeniu



Typ • Type	Cena [EUR/szt.] • Price [EUR/pc]
<b>VKA 125 EKO</b>	200,00
<b>VKA 160 EKO</b>	210,00
<b>VKA 200 EKO</b>	250,00

Typ • Type	Cena [EUR/szt.] • Price [EUR/pc]
<b>VKA 250 EKO</b>	260,00
<b>VKA 315 EKO</b>	320,00

## Wentylator do kanałów prostokątnych • Rectangular duct fan

## VKS

Praca w pomieszczeniu



Typ • Type	Cena [EUR/szt.] • Price [EUR/pc]
<b>VKS 400-200-4 L1</b>	310,00
<b>VKS 400-200-4 L3</b>	290,00
<b>VKS 500-250-4 L1</b>	350,00
<b>VKS 500-250-4 L3</b>	360,00

Typ • Type	Cena [EUR/szt.] • Price [EUR/pc]
<b>VKS 500-300-4 L1</b>	420,00
<b>VKS 500-300-4 L3</b>	430,00
<b>VKS 600-300-4 L1</b>	510,00
<b>VKS 600-300-4 L3</b>	490,00

Typ • Type	Cena [EUR/szt.] • Price [EUR/pc]
<b>VKS 600-350-4 L1</b>	680,00
<b>VKS 600-350-4 L3</b>	640,00
<b>VKS 700-400-4 L3</b>	1 010,00
<b>VKS 800-500-4 L3</b>	1 180,00

Pełna oferta wentylatorów SALDA - na zapytanie.

Ceny przeliczane na PLN w dniu sprzedaży wg kursów średnich NBP.



## Wentylator dachowy • Roof fan

## VSA



Praca na zewnątrz

Typ • Type	Cena [EUR/szt.] • Price [EUR/pc]
VSA 190 L 3.0	120,00
VSA 190 S 3.0	110,00
VSA 220 M 3.0	140,00

Typ • Type	Cena [EUR/szt.] • Price [EUR/pc]
VSA 220 S 3.0	130,00
VSA 225 L 3.0	180,00
VSA 250 L 3.0	180,00

## Wentylator dachowy • Roof fan

## VSA EKO



EKO - silnik EC

Praca na zewnątrz

Typ • Type	Cena [EUR/szt.] • Price [EUR/pc]
VSA 190 EKO	280,00
VSA 220 EKO	350,00

Typ • Type	Cena [EUR/szt.] • Price [EUR/pc]
VSA 225 EKO	430,00
VSA 250 EKO	660,00

## Wentylator dachowy • Roof fan

## VSV



Praca na zewnątrz

Typ • Type	Cena [EUR/szt.] • Price [EUR/pc]
VSV 250-2SL1	270,00
VSV 311-4 L1	390,00
VSV 311-4 L3	410,00
VSV 355-4 L1	470,00
VSV 355-4 L3	460,00
VSV 400-4 L1	560,00

Typ • Type	Cena [EUR/szt.] • Price [EUR/pc]
VSV 400-4 L3	580,00
VSV 450-4 L1	680,00
VSV 450-4 L3	660,00
VSV 500-4 L3	970,00
VSV 560-4 L3	1 220,00
VSV 630-6 L3	1 850,00

Pełna oferta wentylatorów SALDA - na zapytanie.

Ceny przeliczone na PLN w dniu sprzedaży wg kursów średnich NBP.





## Wentylator dachowy • Roof fan

## VSV EKO

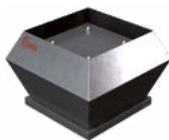

EKO - silnik EC

Praca na zewnątrz

Typ • Type	Cena [EUR/szt.] • Price [EUR/pc]
VSV 311-L1 EKO AL	930,00
VSV 355-L1 EKO AL	1 020,00
VSV 400-L1 EKO AL	1 450,00
VSV 450-L3 EKO AL	1 620,00

Typ • Type	Cena [EUR/szt.] • Price [EUR/pc]
VSV 500-L3 EKO AL	1 770,00
VSV 560-L3 EKO AL	2 120,00
VSV 630-L3 EKO AL	2 310,00

## Wentylator kuchenny • Kitchen fan

## KUB T120



&lt; 120°C

Praca w pomieszczeniu

Praca na zewnątrz

Typ • Type	Cena [EUR/szt.] • Price [EUR/pc]
KUB 355-4L3 T120	930,00
KUB 400-4L3 T120	1 100,00
KUB 450-4L3 T120	1 260,00

Typ • Type	Cena [EUR/szt.] • Price [EUR/pc]
KUB 500-4L3 T120	1 260,00
KUB 560-4L3 T120	1 620,00
KUB 630-4L3 T120	1 850,00

## Wentylator izolowane akustycznie • Acoustically insulated fan

## KUB EKO



Praca w pomieszczeniu

Praca na zewnątrz

Typ • Type	Cena [EUR/szt.] • Price [EUR/pc]
KUB 50-355 EKO	990,00
KUB 67-400 EKO	1 310,00
KUB 67-500 EKO	1 450,00

Typ • Type	Cena [EUR/szt.] • Price [EUR/pc]
KUB 80-560 EKO	1 870,00
KUB 80-630 EKO	2 080,00
KUB 100-630 EKO	2 310,00

Pełna oferta wentylatorów SALDA - na zapytanie.

Ceny przeliczone na PLN w dniu sprzedaży wg kursów średnich NBP.



## Wentylator kuchenny • Kitchen fan

## KF T120 / KF T120 EC



KF T120



KF T120 EC

&lt; 120°C

Praca w pomieszczeniu

Praca na zewnątrz

Typ • Type	Cena [EUR/szt.] • Price [EUR/pc]
<b>KF-T120-160-4 L3</b>	600,00
<b>KF-T120-180-4 L3</b>	670,00
<b>KF-T120-200-4L3</b>	680,00
<b>KF-T120-225-4L3</b>	690,00
<b>KF-T120-250-4L3</b>	770,00
<b>KF-T120-280-4L3</b>	1 010,00
<b>KF-T120-315-4 L3</b>	850,00
<b>KF-T120-355-4 L3</b>	960,00
<b>KF-T120-400-4 L3</b>	980,00

Typ • Type	Cena [EUR/szt.] • Price [EUR/pc]
<b>KF-T120 F 160 EC</b>	870,00
<b>KF-T120 F 180 EC</b>	1 060,00
<b>KF-T120 F 200 EC</b>	1 210,00
<b>KF-T120 F 250 EC</b>	1 310,00
<b>KF-T120 F 280 EC</b>	2 290,00
<b>KF-T120 B 315 EC</b>	1 380,00
<b>KF-T120 B 355 EC</b>	1 230,00
<b>KF-T120 B 400 EC</b>	1 530,00

Pełna oferta wentylatorów SALDA - na zapytanie.

Ceny przeliczane na PLN w dniu sprzedaży wg kursów średnich NBP.



## Wentylatory dachowe Vilpe • Vilpe roof fans

ECO



Typ • Type	Cena [PLNszt.] • Price [PLN/pc]
<b>ECO 190P Ø125/500 mm</b>	1 800,00

Typ • Type	Cena [PLNszt.] • Price [PLN/pc]
<b>ECO 190S Ø125</b>	1 670,00

Dostępne kolory: czarny, brązowy, zielony, szary, czerwony, ceglasty i jasnoszary.

## Wentylatory dachowe Vilpe • Vilpe roof fans

E



Typ • Type	Cena [PLNszt.] • Price [PLN/pc]
<b>E120P Ø125/500 mm</b>	940,00

Typ • Type	Cena [PLNszt.] • Price [PLN/pc]
<b>E190P Ø125/500 mm</b>	1 250,00



Typ • Type	Cena [PLNszt.] • Price [PLN/pc]
<b>E190S Ø125</b>	1 040,00

Typ • Type	Cena [PLNszt.] • Price [PLN/pc]
<b>E220P Ø160/500 mm</b>	2 250,00

Dostępne kolory: czarny, brązowy, zielony, szary, czerwony i ceglasty.



## Wentylator kanałowy • Duct fan

TD



Typ • Type	Cena [PLN/szt.] • Price [PLN/pc]
<b>TD-250/100</b>	445,00
<b>TD-350/125</b>	457,00
<b>TD-500/150 3V</b>	541,00
<b>TD-500/160 3V</b>	541,00
<b>TD-800/200N 3V</b>	689,00
<b>TD-800/200 3V</b>	689,00
<b>TD-1000/250 3V</b>	1 257,00
<b>TD-1300/250 3V</b>	1 325,00
<b>TD-2000/315 3V</b>	1 415,00

Typ • Type	Cena [PLN/szt.] • Price [PLN/pc]
<b>TD-4000/355</b>	2 642,00
<b>TD-6000/400</b>	3 568,00
<b>TD-4000/355 TRIF</b>	2 716,00
<b>TD-6000/400 TRIF</b>	3 659,00
<b>TD-250/100 T</b>	514,00
<b>TD-350/125 T</b>	527,00
<b>TD-500/150 T 3V</b>	612,00
<b>TD-500/160 T 3V</b>	612,00
<b>TD-800/200 T 3V</b>	886,00

## Wentylator kanałowy • Duct fan

TD SILENT



Typ • Type	Cena [PLN/szt.] • Price [PLN/pc]
<b>TD-160/100N SILENT</b>	299,00
<b>TD-160/100 NT SILENT</b>	379,00
<b>TD-250/100 SILENT</b>	550,00
<b>TD-350/125 SILENT</b>	563,00
<b>TD-500/150-160 SILENT 3V</b>	668,00

Typ • Type	Cena [PLN/szt.] • Price [PLN/pc]
<b>TD-800/200 SILENT 3V</b>	851,00
<b>TD-1000/200 SILENT 3V</b>	1 153,00
<b>TD-1300/250 SILENT 3V</b>	2 780,00
<b>TD-2000/315 SILENT 3V</b>	3 233,00



## Wentylator kanałowy • Duct fan

## ILB / ILT



Typ • Type	Cena [PLN/szt.] • Price [PLN/pc]
<b>ILB/4-200</b>	1 645,00
<b>ILB/4-225</b>	1 942,00
<b>ILB/4-250</b>	2 589,00
<b>ILB/6-225</b>	2 242,00
<b>ILB/6-250</b>	2 638,00
<b>ILB/6-285</b>	3 393,00
<b>ILB/6-315</b>	3 928,00
<b>ILB/6-355</b>	4 721,00
<b>ILT/4-200</b>	1 608,00

Typ • Type	Cena [PLN/szt.] • Price [PLN/pc]
<b>ILT/4-225</b>	1 922,00
<b>ILT/4-250</b>	2 565,00
<b>ILT/4-285</b>	3 755,00
<b>ILT/4-315</b>	4 081,00
<b>ILT/4-355</b>	na zapytanie
<b>ILT/4-400</b>	na zapytanie
<b>ILT/4-450</b>	na zapytanie
<b>ILT/6-225</b>	na zapytanie
<b>ILT/6-250</b>	na zapytanie

Typ • Type	Cena [PLN/szt.] • Price [PLN/pc]
<b>ILT/6-285</b>	3 409,00
<b>ILT/6-315</b>	na zapytanie
<b>ILT/6-355</b>	4 625,00
<b>ILT/6-400</b>	6 134,00
<b>ILT/6-450</b>	na zapytanie
<b>ILT/8-355</b>	na zapytanie
<b>ILT/8-400</b>	na zapytanie
<b>ILT/8-450</b>	na zapytanie

## Wentylator kanałowy • Duct fan

## VENT



Typ • Type	Cena [PLN/szt.] • Price [PLN/pc]
<b>VENT-355N</b>	2 423,00
<b>VENT-400N</b>	3 012,00
<b>VENT-100 NK</b>	300,00
<b>VENT-125 NK</b>	300,00
<b>VENT-150 NK</b>	352,00
<b>VENT-160 NK</b>	364,00
<b>VENT-200 NK</b>	493,00
<b>VENT-250 NK</b>	521,00
<b>VENT-315 NK</b>	579,00

Typ • Type	Cena [PLN/szt.] • Price [PLN/pc]
<b>VENT-355N T</b>	na zapytanie
<b>VENT-400N T</b>	na zapytanie
<b>VENT-V-100 N</b>	478,00
<b>VENT-V-125 N</b>	478,00
<b>VENT-V-150 N</b>	568,00
<b>VENT-V-160 N</b>	573,00
<b>VENT-V-200 N</b>	na zapytanie
<b>VENT-V-250 N</b>	na zapytanie
<b>VENT-V-315 N</b>	1 022,00



## Nagrzewnica • Air heater

DH



Typ • Type	Cena [PLN/szt.] • Price [PLN/pc]	Typ • Type	Cena [PLN/szt.] • Price [PLN/pc]	Typ • Type	Cena [PLN/szt.] • Price [PLN/pc]
100/03 S	284,00	200/30 B	562,00	315/60 B	700,00
160/20 S	439,00	200/50 B	594,00	315/60 T	700,00
200/20 S	511,00	200/60 B	605,00	315/90 T	732,00
200/30 T	562,00	250/05 S	477,00	355/120 T	785,00
200/45 T	583,00	250/10 S	509,00	355/150 T	838,00
200/60 T	605,00	250/15 S	541,00	355/30 B	na zapytanie
250/30 S	636,00	250/20 S	573,00	355/30 S	732,00
250/45 T	636,00	250/25 S	605,00	355/50 B	na zapytanie
250/60 T	658,00	250/30 B	615,00	355/60 B	721,00
100/06 S	315,00	250/50 B	647,00	355/60 T	721,00
100/09 S	347,00	250/60 B	658,00	355/90 T	753,00
100/12 S	390,00	250/90 T	711,00	400/120 T	933,00
125/03 S	311,00	315/10 S	573,00	400/150 T	986,00
125/06 S	343,00	315/120 T	764,00	400/180 T	1 051,00
125/09 S	374,00	315/15 S	605,00	400/30 B	774,00
125/12 S	406,00	315/20 S	636,00	400/30 S	774,00
160/05 S	321,00	315/25 S	668,00	400/50 B	796,00
160/10 S	364,00	315/30 B	na zapytanie	400/60 B	806,00
160/15 S	396,00	315/30 S	700,00	400/60 T	806,00
200/10 S	469,00	315/30 T	658,00	400/90 T	838,00
200/15 S	490,00	315/45 T	679,00	250/30 T	615,00
200/25 S	532,00	315/50 B	690,00	200/05 S	448,00



## Wentylator osiowy • Axial-flow fan

## HCFB / HCFT



Typ•Type	Cena[PLN/szt.]•Price[PLN/pc]
HCFB/4-250/H	944,00
HCFB/4-315/H	971,00
HCFB/4-355/H	1 218,00
HCFB/4-400/H	1 304,00
HCFB/4-450/H	1 732,00
HCFB/4-500/H	1 905,00
HCFT/4-250/H	900,00

Typ•Type	Cena[PLN/szt.]•Price[PLN/pc]
HCFT/4-315/H	927,00
HCFT/4-355/H	1 160,00
HCFT/4-400/H	1 247,00
HCFT/4-450/H	1 660,00
HCFT/4-500/H	1 826,00
HCFT/4-560/H	2 637,00
HCFT/4-630/H	2 927,00

## Wentylator dachowy • Roof fan

## RF



Typ•Type	Cena[PLN/szt.]•Price[PLN/pc]
RF/2-125S	541,00
RF/4-125S	626,00
RF/2-160S	605,00
RF/4-160S	647,00
RF/2-200S	1 008,00
RF/4-200S	859,00
RF/4-250S	1 570,00
RF/4-250T	1 793,00
RF/6-250S	1 623,00
RF/4-315S	1 867,00
RF/4-315T	1 867,00

Typ•Type	Cena[PLN/szt.]•Price[PLN/pc]
RF/6-315S	1 809,00
RF/4-355S	2 111,00
RF/4-355T	2 111,00
RF/6-355T	2 281,00
RF/4-400S SN	3 554,00
RF/4-400T SN	3 501,00
RF/4-450S	4 144,00
RF/4-450T SN	3 978,00
RF/4-500T SN	6 312,00
RF/6-500S SN	5 007,00



## Wentylator dachowy • Roof fan

TH



Typ • Type	Cena [PLN/szt.] • Price [PLN/pc]
TH-500/160 3V out	1 263,00
TH-800/200N 3V out	1 493,00
TH-800/200 3V out	1 493,00

Typ • Type	Cena [PLN/szt.] • Price [PLN/pc]
TH-1300 3V out	2 450,00
TH-2000 3V out	2 799,00

## Wentylator dachowy • Roof fan

RFV ZN



Typ • Type	Cena [PLN/szt.] • Price [PLN/pc]
RFV/2-125 ZN	573,00
RFV/4-125 ZN	647,00
RFV/2-160 ZN	737,00
RFV/4-160 ZN	796,00
RFV/2-200 ZN	1 131,00
RFV/4-200S ZN	998,00
RFV/4-250S ZN	1 803,00

Typ • Type	Cena [PLN/szt.] • Price [PLN/pc]
RFV/4-250T ZN	1 809,00
RFV/6-250 ZN	1 623,00
RFV/4-315S ZN	1 835,00
RFV/4-315T ZN	1 729,00
RFV/4-355S ZN	2 281,00
RFV/4-355T ZN	2 281,00

## Wentylator łazienkowy i kuchenny • Fan for bathroom and kitchen

SILENT



Typ • Type	Cena [PLN/szt.] • Price [PLN/pc]
SILENT 100 CZ	196,00
SILENT 100 CZ 12V	219,00
SILENT 100 CZ ECOWATT	295,00
SILENT 200 CZ	251,00
SILENT 300 CZ	313,00
SILENT 300 CZ PLUS	340,00
SILENT 100 CRZ	258,00
SILENT 100 CRIZ	290,00
SILENT 100 CHZ	453,00

Typ • Type	Cena [PLN/szt.] • Price [PLN/pc]
SILENT 100 CDZ	430,00
SILENT 100 CRZ ECOWATT	388,00
SILENT 200 CRZ	311,00
SILENT 200 CHZ	482,00
SILENT 300 CRZ	451,00
SILENT 300 CHZ	511,00
SILENT 300 CRZ PLUS	478,00
SILENT 300 CHZ PLUS	523,00





## Wentylator łazienkowy i kuchenny • Fan for bathroom and kitchen

### DECOR



Typ • Type	Cena [PLN/szt.] • Price [PLN/pc]
<b>DECOR 100 CZ</b>	179,00
<b>DECOR 200 CZ</b>	219,00
<b>DECOR 300 SZ</b>	232,00
<b>DECOR 100 C - 12V</b>	226,00
<b>DECOR 100 CRZ</b>	224,00
<b>DECOR 100 CHZ</b>	407,00
<b>DECOR 100 CDZ</b>	407,00

Typ • Type	Cena [PLN/szt.] • Price [PLN/pc]
<b>DECOR 200 CRZ</b>	296,00
<b>DECOR 200 CHZ</b>	458,00
<b>DECOR 300 RZ</b>	329,00
<b>DECOR 300 HZ</b>	467,00
<b>DECOR 300 CZ</b>	335,00
<b>DECOR 300 CRZ</b>	439,00
<b>DECOR 300 CHZ</b>	486,00

## Wentylator łazienkowy i kuchenny • Fan for bathroom and kitchen

### EDM



Typ • Type	Cena [PLN/szt.] • Price [PLN/pc]
<b>EDM 80 NZ</b>	122,00
<b>EDM 100 SZ</b>	126,00
<b>EDM 200 SZ</b>	179,00

Typ • Type	Cena [PLN/szt.] • Price [PLN/pc]
<b>EDM 100 TZ</b>	190,00
<b>EDM 100 CZ</b>	189,00
<b>EDM 100 CTZ</b>	224,00

## Wentylator łazienkowy i kuchenny • Fan for bathroom and kitchen

### SILENT DESIGN

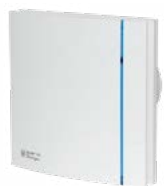

Typ • Type	Cena [PLN/szt.] • Price [PLN/pc]
<b>SILENT DESIGN</b>	
<b>100 CZ</b>	222,00
<b>100 CRZ</b>	287,00
<b>100 CHZ</b>	461,00
<b>200 CZ</b>	263,00
<b>200 CRZ</b>	325,00
<b>200 CHZ</b>	499,00
<b>300 CRZ</b>	541,00

Typ • Type	Cena [PLN/szt.] • Price [PLN/pc]
<b>SILENT SILVER DESIGN</b>	
<b>100 CZ</b>	253,00
<b>100 CRZ</b>	na zapytanie
<b>100 CHZ</b>	500,00
<b>200 CZ</b>	304,00
<b>200 CRZ</b>	365,00
<b>200 CHZ</b>	513,00
<b>300 CRZ</b>	na zapytanie

Zestawienia produktów Venture Industries zawierają ceny wybranych urządzeń.

Wentylator dachowy standardowy • *Standard roof fan*

DAs



Typ • <i>Type</i>	Napięcie 3 x 400 V	Napięcie 1 x 230 V	2-biegowe napięcie 3 x 400 V	3-biegowe napięcie 3 x 400 V
	Cena [PLN/szt.] • <i>Price [PLN/pc]</i>			
<b>DAs-160</b>	1 900,00	2 000,00	x	x
<b>DAs-200</b>	2 180,00	2 280,00	2 630,00	3 235,00
<b>DAs-250</b>	2 950,00	3 050,00	3 235,00	3 550,00
<b>DAs-315</b>	3 905,00	4 005,00	4 125,00	4 250,00
<b>DAs-400</b>	8 275,00	x	x	x
<b>DAs-500</b>	10 780,00	x	x	x
<b>DAs-630</b>	16 755,00	x	x	x

Wentylator dachowy kwasoodporny • *Acid-resistant roof fan*

DAk



Typ • <i>Type</i>	Napięcie 3 x 400 V	Napięcie 1 x 230 V	2-biegowe napięcie 3 x 400 V	3-biegowe napięcie 3 x 400 V
	Cena [PLN/szt.] • <i>Price [PLN/pc]</i>			
<b>DAk-160</b>	2 440,00	2 540,00	x	x
<b>DAk-200</b>	2 930,00	3 030,00	3 570,00	4 060,00
<b>DAk-250</b>	3 730,00	3 830,00	4 005,00	4 260,00
<b>DAk-315</b>	4 590,00	4 690,00	4 810,00	5 060,00
<b>DAk-400</b>	9 225,00	x	x	x
<b>DAk-630</b>	16 755,00	x	x	x

Wentylator dachowy przeciwybuchowy • *Anti-explosive roof fan*

DAEx



Typ • <i>Type</i>	3 x 400 V / gazy klasa T3	3 x 400 V / pyły	3 x 400 V / gazy klasa T4
	Cena [PLN/szt.] • <i>Price [PLN/pc]</i>		
<b>DAExC-160</b>	3 270,00	3 270,00	3 600,00
<b>DAExC-200</b>	3 760,00	3 760,00	4 140,00
<b>DAExC-250</b>	5 320,00	5 320,00	5 850,00
<b>DAExC-315</b>	6 470,00	6 470,00	7 120,00
<b>DAExC-400</b>	11 700,00	11 700,00	12 870,00
<b>DAExC-630</b>	27 600,00	27 600,00	30 360,00

Wentylator dachowy cichobieżny • *Roof fan*

SILWENT



Typ • <i>Type</i>	Napięcie 3 x 400 V	Napięcie 1 x 230 V	Dwubiegowe Napięcie 3 x 400 V
	Cena [PLN/szt.] • <i>Price [PLN/pc]</i>		
<b>SILWENT-160/MW</b>	3 050,00	3 050,00	x
<b>SILWENT-315</b>	5 270,00	x	5 270,00

Wentylator dachowy izolowany akustycznie • *Acoustic roof fan*

SZTIL



Typ • <i>Type</i>	Napięcie 3 x 400 V	Napięcie 1 x 230 V
	Cena [PLN/szt.] • <i>Price [PLN/pc]</i>	
<b>SZTIL-160/W2</b>	2 270,00	2 370,00
<b>SZTIL-200/W2</b>	2 590,00	2 690,00
<b>SZTIL-250/W2</b>	2 940,00	3 040,00
<b>SZTIL-315</b>	3 435,00	3 535,00
<b>SZTIL-400/MW</b>	10 080,00	10 180,00
<b>SZTIL-500</b>	13 440,00	x

# WENTYLATORY

Wentylatory i wywiewniki Uniwersal • *Universal fans and graviation fans*



## Wentylator dachowy • *Roof fan*

**FEN**



Typ • <i>Type</i>	Napięcie 3 x 400V	Napięcie 1 x 230V
	Cena [PLN/szt.] • <i>Price [PLN/pc]</i>	
<b>FEN-160</b>	1 860,00	1 960,00
<b>FEN-250</b>	2 820,00	2 920,00
<b>FEN-315</b>	3 480,00	3 580,00
<b>FEN-400</b>	8 750,00	×
<b>FEN-500</b>	8 970,00	×

## Wywiewnik • *Graviation fan*

**WLO**



Typ • <i>Type</i>	Cena [PLN/szt.] • <i>Price [PLN/pc]</i>
<b>WLO-160</b>	490,00
<b>WLO-200</b>	1 140,00
<b>WLO-250</b>	1 220,00
<b>WLO-315</b>	1 545,00
<b>WLO-400</b>	2 350,00
<b>WLO-630</b>	5 870,00

## Wywiewnik • *Graviation fan*

**ZEFIR**



Typ • <i>Type</i>	Laminat z PŁYTĄ MONTAŻOWĄ • <i>Laminat</i>	Laminat NA RURĘ PVC • <i>Rustproof</i>
	Cena [PLN/szt.] • <i>Price [PLN/pc]</i>	
<b>ZEFIR-140</b>	340,00	380,00
<b>ZEFIR-250</b>	800,00	980,00

## Wywiewnik zintegrowany • *Integrated ventilating fan*

**WZ**



Typ • <i>Type</i>	WZ Standardowy • <i>Laminat</i>	WZk Kwasoodporny • <i>Acid-resistant</i>	WZEx Przeciwwybuchowy • <i>Anti-explosive</i>
	Cena [PLN/szt.] • <i>Price [PLN/pc]</i>		
<b>WZ 315/160</b>	1 950,00	1 950,00	2 900,00
<b>WZ 400/250</b>	2 970,00	2 970,00	3 900,00
<b>WZ 630/315</b>	3 900,00	3 900,00	5 220,00

Cena zawiera jedynie koszt wywiewnika właściwego (nie zawiera ceny wentylatora, ani podstawy dachowej).  
• *Price includes only the cost of the vent (excluding price of the fan and roof base).*

## Wentylator osiowy

• *Axial-flow fan*

## AKWILON



Typ • <i>Type</i>	Napięcie 3 x 400 V	Napięcie 1 x 230 V
	Cena [PLN/szt.] • <i>Price [PLN/pc]</i>	
<b>500</b>	3 205,00	3 305,00
<b>500/DA</b>	3 535,00	3 635,00

## Wentylator kanałowy

• *Duct fan*

## VENTO



Typ • <i>Type</i>	Napięcie 3 x 400 V do 40°C	Napięcie 1 x 230 V do 40°C
	Cena [PLN/szt.] • <i>Price [PLN/pc]</i>	
<b>200</b>	2 080,00	2 180,00

## Podstawa dachowa tłumiąca

• *Insulating roof fan*



Typ • <i>Type</i>	PTL	PTS
	Cena [PLN/szt.] • <i>Price [PLN/pc]</i>	
<b>160</b>	1 640,00	1 350,00
<b>200</b>	1 880,00	1 500,00
<b>250</b>	2 360,00	1 650,00
<b>315</b>	2 950,00	2 260,00
<b>400</b>	5 255,00	4 000,00
<b>500</b>	×	4 715,00
<b>630</b>	×	4 715,00

## Podstawa dachowa typ B/I

• *Roof fan, type B/I*

Typ • <i>Type</i>	LAMINAT	STAL • <i>STEEL</i>	LAMINAT EX
	Cena [PLN/szt.] • <i>Price [PLN/pc]</i>		
<b>160</b>	285,00	240,00	320,00
<b>200</b>	385,00	270,00	420,00
<b>250</b>	440,00	315,00	460,00
<b>315</b>	600,00	350,00	680,00
<b>400</b>	850,00	470,00	920,00
<b>500</b>	990,00	590,00	×
<b>630</b>	1 100,00	770,00	1 300,00

Zestawienia produktów Uniwersal zawierają ceny wybranych urządzeń.



## Wentylator do kanałów okrągłych • Fan for circular ducts

K



Typ • Type	Cena [PLN/szt.] • Price [PLN/pc]
<b>100 M sileo</b>	351,00
<b>100 XL sileo</b>	385,00
<b>125 M sileo</b>	355,00
<b>125 XL sileo</b>	389,00
<b>150 M sileo</b>	391,00
<b>150 XL sileo</b>	459,00
<b>160 M sileo</b>	391,00

Typ • Type	Cena [PLN/szt.] • Price [PLN/pc]
<b>160 XL sileo</b>	459,00
<b>200 L sileo</b>	569,00
<b>200 M sileo</b>	463,00
<b>250 L sileo</b>	569,00
<b>250 M sileo</b>	463,00
<b>315 Sileo</b>	761,00

## Wentylator do kanałów okrągłych z silnikiem EC • Fan for circular ducts

K EC



Typ • Type	Cena [PLN/szt.] • Price [PLN/pc]
<b>100 EC sileo</b>	929,00
<b>125 EC sileo</b>	960,00
<b>160 EC sileo</b>	1 030,00
<b>200 EC sileo</b>	1 069,00

Typ • Type	Cena [PLN/szt.] • Price [PLN/pc]
<b>250 EC sileo</b>	1 372,00
<b>315L EC</b>	2 683,00
<b>315M EC</b>	2 052,00

## Wentylator do kanałów okrągłych • Fan for circular ducts

KV



Typ • Type	Cena [PLN/szt.] • Price [PLN/pc]
<b>100 M sileo</b>	488,00
<b>100 XL sileo</b>	520,00
<b>125 M sileo</b>	494,00
<b>125 XL sileo</b>	533,00
<b>150 M sileo</b>	539,00
<b>150 XL sileo</b>	635,00
<b>160 M sileo</b>	539,00

Typ • Type	Cena [PLN/szt.] • Price [PLN/pc]
<b>160 XL sileo</b>	631,00
<b>200 L sileo</b>	787,00
<b>200 M sileo</b>	641,00
<b>250 L sileo</b>	787,00
<b>250 M sileo</b>	641,00
<b>315 sileo</b>	1 024,00



## Wentylator do kanałów okrągłych • Fan for circular ducts

## RVK



Typ • Type	Cena [PLN/szt.] • Price [PLN/pc]
<b>100E2-A1 sileo</b>	355,00
<b>125E2-A1 sileo</b>	355,00
<b>125E2-L sileo</b>	401,00
<b>150E2 sileo</b>	426,00
<b>150E2-L sileo</b>	481,00

Typ • Type	Cena [PLN/szt.] • Price [PLN/pc]
<b>160E2 sileo</b>	426,00
<b>160E2-L sileo</b>	481,00
<b>200E2 sileo</b>	491,00
<b>200E2-L sileo</b>	601,00

## Wentylator do okapów kuchennych • Fan for kitchen hoods

## KBT / KBR



Typ • Type	Cena [PLN/szt.] • Price [PLN/pc]
<b>KBT</b>	
<b>160DV</b>	4 386,00
<b>160E4</b>	4 863,00
<b>180E4</b>	5 062,00
<b>200DV</b>	5 062,00
<b>200E4</b>	5 364,00
<b>225D4 IE2</b>	4 727,00
<b>225E4</b>	5 473,00
<b>250D4 IE2</b>	5 751,00
<b>250E4</b>	6 851,00
<b>280D4 IE2</b>	6 246,00

Typ • Type	Cena [PLN/szt.] • Price [PLN/pc]
<b>KBR</b>	
<b>280D2-4</b>	7 424,00
<b>315D2 IE2</b>	6 273,00
<b>315DV</b>	6 338,00
<b>315E4</b>	6 549,00
<b>355D2 IE2</b>	7 700,00
<b>355D2/K IE2</b>	6 665,00
<b>355DV</b>	7 056,00
<b>355DV/K</b>	6 801,00
<b>355E4</b>	7 505,00
<b>355E4/K</b>	7 270,00

## Wentylator do kanałów prostokątnych • Fan for rectangular ducts

## KT



Typ • Type	Cena [PLN/szt.] • Price [PLN/pc]
<b>40-20-4</b>	1 657,00
<b>50-25-4</b>	2 025,00
<b>50-25-6</b>	2 052,00
<b>60-30-4</b>	3 351,00
<b>60-30-6</b>	2 631,00

Typ • Type	Cena [PLN/szt.] • Price [PLN/pc]
<b>60-35-4</b>	4 083,00
<b>60-35-6</b>	3 459,00
<b>70-40-4</b>	6 326,00
<b>70-40-6</b>	4 238,00
<b>80-50-6</b>	6 878,00



## Wentylator do kanałów prostokątnych • Fan for rectangular ducts

RS



Typ • Type	Cena [PLN/szt.] • Price [PLN/pc]
<b>30-15</b>	899,00
<b>40-20 L</b>	1 191,00
<b>40-20 M</b>	1 116,00
<b>50-25</b>	1 784,00
<b>60-35 L1 sileo</b>	3 177,00
<b>60-35 L3</b>	3 612,00
<b>60-35 M1</b>	3 338,00

Typ • Type	Cena [PLN/szt.] • Price [PLN/pc]
<b>60-35 M3 sileo</b>	3 159,00
<b>70-40 L1 sileo</b>	3 416,00
<b>70-40 L3</b>	3 804,00
<b>80-50 L3</b>	5 203,00
<b>80-50 M3</b>	4 893,00
<b>100-50 L3</b>	7 210,00

## Wentylator dachowy • Roof fan

TFSR / TFSK



Typ • Type	Cena [PLN/szt.] • Price [PLN/pc]
<b>TFSR / TFSR EC</b>	
<b>125 M</b>	658,00
<b>125 XL</b>	741,00
<b>160 Sileo</b>	746,00
<b>160 EC Sileo</b>	1 658,00
<b>200</b>	873,00
<b>200 EC Sileo</b>	1 787,00
<b>315 sileo</b>	1 421,00
<b>TFSK / TFSK EC</b>	
<b>125 M</b>	658,00
<b>125 XL</b>	775,00
<b>160</b>	743,00
<b>160 EC</b>	1 658,00
<b>200</b>	869,00
<b>200 EC</b>	1 787,00
<b>315 sileo</b>	1 415,00





## Wentylator dachowy • Roof fan

## DHS



Typ • Type	Cena [PLN/szt.] • Price [PLN/pc]
<b>190EZ sileo</b>	1 204,00
<b>225EZ sileo</b>	1 243,00
<b>310EV</b>	2 283,00
<b>311EV sileo</b>	2 138,00
<b>355DV sileo</b>	2 999,00
<b>355E4 sileo</b>	2 896,00
<b>400DS sileo</b>	3 238,00
<b>400DV sileo</b>	3 124,00
<b>400E4 sileo</b>	3 051,00
<b>400E6 sileo</b>	3 137,00
<b>450DV sileo</b>	3 838,00

Typ • Type	Cena [PLN/szt.] • Price [PLN/pc]
<b>450E4 sileo</b>	4 027,00
<b>450E6 sileo</b>	3 828,00
<b>500DS sileo</b>	4 297,00
<b>500DV sileo</b>	5 564,00
<b>500E6 sileo</b>	5 075,00
<b>560DS sileo</b>	6 113,00
<b>560DV sileo</b>	7 017,00
<b>630DS sileo</b>	7 317,00
<b>630DV sileo</b>	8 030,00
<b>710DS</b>	11 053,00

## Wentylator dachowy • Roof fan

## DVS



Typ • Type	Cena [PLN/szt.] • Price [PLN/pc]
<b>sileo 190EZ</b>	994,00
<b>sileo 225EZ</b>	977,00
<b>310EV</b>	1 885,00
<b>311EV sileo</b>	1 765,00
<b>355DV sileo</b>	2 477,00
<b>355E4 sileo</b>	2 391,00
<b>400DS sileo</b>	2 674,00
<b>400DV sileo</b>	2 579,00
<b>400E6 sileo</b>	2 614,00
<b>400E4 sileo</b>	2 519,00
<b>450DV sileo</b>	3 171,00

Typ • Type	Cena [PLN/szt.] • Price [PLN/pc]
<b>450E4 sileo</b>	3 325,00
<b>450E6 sileo</b>	3 196,00
<b>500DS sileo</b>	3 548,00
<b>500DV sileo</b>	4 499,00
<b>500E6 sileo</b>	4 190,00
<b>560DS sileo</b>	5 047,00
<b>560DV sileo</b>	5 673,00
<b>630DS sileo</b>	6 041,00
<b>630DV sileo</b>	7 063,00
<b>710DS</b>	9 126,00
<b>710DV sileo</b>	8 552,00

Zestawienia produktów Systemair zawierają ceny wybranych urządzeń.



## Wentylator do okapów kuchennych • Kitchen fan

KBA



Typ • Type	Cena [EUR/szt.] • Price [EUR/pc]
<b>KBAD 180-4</b>	843,00
<b>KBAD 200-4</b>	912,00
<b>KBAD 225-4</b>	994,00
<b>KBAD 250-4</b>	1 132,00
<b>KBAD 280-4</b>	1 160,00
<b>KBAD 315-2</b>	1 374,00
<b>KBAD 315-4</b>	1 158,00

Typ • Type	Cena [EUR/szt.] • Price [EUR/pc]
<b>KBAD 355-2</b>	1 449,00
<b>KBAD 355-4</b>	1 227,00
<b>KBAD 400-4</b>	1 269,00
<b>KBAD 450-4</b>	2 084,00
<b>KBAD 500-4</b>	2 128,00
<b>KBAE 180-4</b>	815,00
<b>KBAE 200-4</b>	882,00

Typ • Type	Cena [EUR/szt.] • Price [EUR/pc]
<b>KBAE 225-4</b>	971,00
<b>KBAE 250-4</b>	1 126,00
<b>KBAE 280-4</b>	1 141,00
<b>KBAE 315-4</b>	1 120,00
<b>KBAE 355-4</b>	1 212,00
<b>KBAE 400-4</b>	1 252,00

## Wentylator dachowy • Roof fan

DVWN



Typ • Type	Cena [EUR/szt.] • Price [EUR/pc]
<b>310L-4 D</b>	886,00
<b>355-4 D</b>	901,00
<b>355-4 E</b>	923,00
<b>400-4 D</b>	984,00
<b>400-4 E</b>	989,00

Typ • Type	Cena [EUR/szt.] • Price [EUR/pc]
<b>450-4 D</b>	1 200,00
<b>450-4 E</b>	1 191,00
<b>500-4 D</b>	1 472,00
<b>500-4 E</b>	1 431,00
<b>560-4 D</b>	1 808,00

Typ • Type	Cena [EUR/szt.] • Price [EUR/pc]
<b>630-4 D 80C</b>	2 127,00
<b>630-4 D 120C</b>	2 127,00
<b>710-6 D</b>	2 889,00

Ceny przeliczone na PLN w dniu sprzedaży wg kursów średnich NBP.



## Wentylator dachowy • Roof fan

## DV / DVE



Typ • Type	Cena [EUR/szt.] • Price [EUR/pc]
DV 190-2 E	218,00
DV 225-2 E	265,00
DV 280-2 E	413,00
DV 280-4 E	447,00
DV 355-4 D Ex	1 109,00
DV 400-4 D Ex	1 202,00
DV 450-4 D Ex	1 431,00

Typ • Type	Cena [EUR/szt.] • Price [EUR/pc]
DVE 310-4 E	360,00
DVE 310-4 D	455,00
DVE 310L-4 D Ex	805,00
DVE 355-4 E	613,00
DVE 355-4 D	588,00
DVE 400-4 E	663,00
DVE 400-4 D	633,00

## Wentylator dachowy • Roof fan

## DH / DHE



Typ • Type	Cena [EUR/szt.] • Price [EUR/pc]
DH 190-2 E	173,00
DH 225-2 E	212,00
DH 280-2 E	357,00
DH 280-4 E	397,00
DH 310L-4 D Ex	770,00
DH 355-4 D Ex	1 037,00
DH 400-4 D Ex	1 089,00
DH 450-4 D Ex	1 339,00
DH 500-4 D Ex	1 782,00
DH 560-4 D Ex	2 445,00
DH 630-6 D Ex	2 334,00
DHE 310-4 E	323,00
DHE 310-4 D	413,00
DHE 355-4 E	525,00

Typ • Type	Cena [EUR/szt.] • Price [EUR/pc]
DHE 355-4 D	503,00
DHE 400-4 E	583,00
DHE 400-4 D	580,00
DHE 450-4 E	770,00
DHE 450-4 D	675,00
DHE 450-6 D	710,00
DHE 500-4 E	880,00
DHE 500-4 D	838,00
DHE 500-6 D	798,00
DHE 560-4 D	1 190,00
DHE 560-6 D	1 043,00
DHE 630-4 D	1 618,00
DHE 630-6 D	1 313,00

Ceny przeliczone na PLN w dniu sprzedaży wg kursów średnich NBP.



## Wentylator do kanałów okrągłych • Fan for circular ducts

R



Typ • Type	Cena [EUR/szt.] • Price [EUR/pc]
<b>R 100</b>	80,00
<b>R 100 G</b>	225,00
<b>R 125</b>	80,00
<b>R 125 G</b>	227,00
<b>R 150</b>	112,00
<b>R 160</b>	114,00
<b>R 160 L</b>	123,00
<b>R 160 G</b>	229,00
<b>R 200</b>	128,00
<b>R 200 G</b>	253,00

Typ • Type	Cena [EUR/szt.] • Price [EUR/pc]
<b>R 250</b>	126,00
<b>R 250 L</b>	137,00
<b>R 250 G</b>	267,00
<b>R 315</b>	179,00
<b>R 315 M</b>	182,00
<b>R 315 G</b>	396,00
<b>R 315 L G</b>	400,00
<b>R 355 M</b>	357,00
<b>R 355 G</b>	634,00
<b>R 355 L G</b>	685,00

\* Konsola montażowa w standardzie.

## Wentylator do kanałów okrągłych • Fan for circular ducts

RS



Typ • Type	Cena [EUR/szt.] • Price [EUR/pc]
<b>RS 100 L</b>	86,00
<b>RS 125 L</b>	106,00
<b>RS 150</b>	113,00
<b>RS 160</b>	113,00
<b>RS 160 L</b>	132,00

Typ • Type	Cena [EUR/szt.] • Price [EUR/pc]
<b>RS 200</b>	132,00
<b>RS 250</b>	135,00
<b>RS 250 L</b>	143,00
<b>RS 315</b>	190,00
<b>RS 315 M</b>	198,00

## Wentylator do kanałów okrągłych • Fan for circular ducts

Zero-Box



Typ • Type	Cena [EUR/szt.] • Price [EUR/pc]
<b>Z 125 R1</b>	253,00
<b>Z 160 R2</b>	263,00
<b>Z 200 R1</b>	323,00
<b>Z 250 R1</b>	368,00

Typ • Type	Cena [EUR/szt.] • Price [EUR/pc]
<b>Z 315 R1</b>	513,00
<b>Z 355 R1</b>	610,00
<b>Z 400 R1</b>	630,00

Ceny przeliczane na PLN w dniu sprzedaży wg kursów średnich NBP.



## Wentylator do kanałów prostokątnych • Fan for rectangular ducts

EKA



Typ • Type	Cena [EUR/szt.] • Price [EUR/pc]
<b>EKAD 250-4.5FA</b>	438,00
<b>EKAD 315-4.6HF</b>	649,00
<b>EKAD 400-6.7KF</b>	1 061,00
<b>EKAD 200-4 Ex</b>	578,00
<b>EKAD 225-4 Ex</b>	670,00
<b>EKAD 250-4 Ex</b>	776,00

Typ • Type	Cena [EUR/szt.] • Price [EUR/pc]
<b>EKAD 280-4 Ex</b>	845,00
<b>EKAD 280-6 Ex</b>	783,00
<b>EKAD 315-6 Ex</b>	888,00
<b>EKAD 315-4 Ex</b>	965,00
<b>EKAD 355-6 Ex</b>	1 020,00

## Wentylator do kanałów prostokątnych • Fan for rectangular ducts

KHA



Typ • Type	Cena [EUR/szt.] • Price [EUR/pc]
<b>KHAE 225-2.3CA W</b>	291,00
<b>KHAE 250-2.3EF W</b>	337,00
<b>KHAE 280-2.5DF W</b>	500,00
<b>KHAE 280-2.5DF WS</b>	742,00
<b>KHAD 280-2.5DF W</b>	559,00
<b>KHAD 280-2.5DF WS</b>	775,00
<b>KHAE 315-4.4DA W</b>	707,00
<b>KHAE 315-4.4DA WS</b>	689,00
<b>KHAD 315-4.4DA W</b>	487,00
<b>KHAD 315-4.4DA WS</b>	704,00
<b>KHAE 355-4.4FF W</b>	605,00
<b>KHAE 355-4.4FF WS</b>	918,00
<b>KHAD 355-4.4EC W</b>	610,00

Typ • Type	Cena [EUR/szt.] • Price [EUR/pc]
<b>KHAD 355-4.4EC WS</b>	920,00
<b>KHAE 400-4.5FA W</b>	669,00
<b>KHAE 400-4.5FA WS</b>	999,00
<b>KHAD 400-4.5DF W</b>	685,00
<b>KHAD 400-4.5DF WS</b>	1 006,00
<b>KHAE 500-4.6HF W</b>	1 050,00
<b>KHAD 500-4.6HF W</b>	1 006,00
<b>KHAD 450-4.5HA WS</b>	1 160,00
<b>KHAD 450-4.5HA W</b>	784,00
<b>KHAE 500-4.6HF WS</b>	1 582,00
<b>KHAE 450-4.5HA WS</b>	1 151,00
<b>KHAE 450-4.5HA W</b>	764,00
<b>KHAD 500-4.6HF WS</b>	1 525,00

Zestawienia produktów Rosenberg zawierają ceny wybranych urządzeń.

Ceny przeliczane na PLN w dniu sprzedaży wg kursów średnich NBP.

2020-03-16 CENY PODANE W CENNIKU LINDAB SP. Z O.O. NIE ZAWIERAJĄ PODATKU VAT

/ RATES IN THIS PRICELIST ARE NET PRICES



## Aparat grzewczo-wentylacyjny • Heating and ventilation unit

LEO



Typ • Type	Moc nominalna • Heating power [kW]	Cena [PLN/szt.] • Price [PLN/pc]
LEO S1	0,7 - 12,8	1 030,00
LEO S2	2,1 - 26,5	1 040,00
LEO S3	1,7 - 32,7	1 150,00
LEO L1	1,3 - 32,3	1 290,00
LEO L2	2,2 - 50,4	1 420,00
LEO L3	3,2 - 65,2	1 490,00
LEO XL2	6,6 - 94,0	2 110,00
LEO XL3	8,3 - 121,0	2 670,00
LEO S1 zestaw	0,7 - 12,8	1 120,00
LEO S2 zestaw	2,1 - 26,5	1 130,00
LEO S3 zestaw	1,7 - 32,7	1 240,00
LEO L1 zestaw	1,3 - 32,3	1 390,00
LEO L2 zestaw	2,2 - 50,4	1 520,00
LEO L3 zestaw	3,2 - 65,2	1 590,00
LEO XL2 zestaw	6,6 - 94,0	2 230,00
LEO XL3 zestaw	8,3 - 121,0	2 790,00

## Akcesoria • Accessories

SRQ2d-1/2	SRQ3d-1/2	SRQ2d-3/4	SRQ3d-3/4	TS
zawory z siłownikiem • the valve with servomotor				trzystopniowy regulator prędkości obrotowej z termostatem • three-stages adjuster of the rotation speed with thermostat
Cena [PLN/szt.] • Price [PLN/pc]				
225,00	260,00	240,00	260,00	94,00



## Kurtyna powietrzna - Air curtain

## WING



Typ - Type	Zakres mocy grzewczej ▪ Heating power range [kW]	Maks. wydatek powietrza ▪ Max airflow [m <sup>3</sup> /h]	Cena [PLN/szt.] - Price [PLN/pc]
<b>Kurtyna powietrzna z wymiennikiem wodnym</b>			
<b>WING W100 (EC)</b>	4 - 17	1850	1 939,00
<b>WING W150 (EC)</b>	10 - 32	3100	2 389,00
<b>WING W200 (EC)</b>	17 - 47	4400	2 949,00
<b>Kurtyna powietrzna z grzałkami elektrycznymi</b>			
<b>WING E100 (EC)</b>	2/6 lub 4/6	1850	1 939,00
<b>WING E150 (EC)</b>	4/12 lub 8/12	3150	2 389,00
<b>WING E200 (EC)</b>	6/15 lub 9/15	4500	2 949,00
<b>Kurtyna powietrzna bez wymiennika (zimna)</b>			
<b>WING C100 (EC)</b>	-	1950	1 589,00
<b>WING C150 (EC)</b>	-	3200	2 049,00
<b>WING C200 (EC)</b>	-	4600	2 499,00

## Osprzęt do kurtyń powietrznych - Accessories for air curtains

Nazwa - Name	Cena [PLN/szt.] - Price [PLN/pc]
Zestaw uchwytych WING 100	69,00
Zestaw uchwytych WING 150/200	100,00
Sterownik naścienny WING EC	299,00
Zawór z siłownikiem	207,00



## Kurtyna powietrzna • Air curtain

RM



Typ • Type		RM125-12	RM125-15
Moc grzałek • Power [kW]	I	2,3	3,0
	II	4,5	6,0
Pobór prądu • Amp/phase [A]		33	41
Pobór mocy wentylatora • Motor power [W]		150	168
Temp. powietrza • Outlet temperature [°C]		40-50	
Prędkość powietrza • Air Speed [m/s]		6÷7	
Wydajność • Air flow [m³/h]		1280	1670
Hałas • Noise [dB(A)]		57	59
Wymiary • Dimensions W×H×D [mm]		1200×221×183	1500×221×183
Cena [PLN/szt.] • Price [PLN/pc]		1 769,31	2 174,01
		968,76	1 189,86





## Kurtyna powietrzna • Air curtain

ADA / PA



Wyszczególnienie • Description	Szerokość • Width [mm]	Napięcie • Voltage [V]	Moc • Power [kW]	Cena [PLN/szt.] • Price [PLN/pc]
<b>Seria ADA - montaż do 2,5 m • ADA series - assembly up to 2,5 m</b>				
<b>ADA090H</b>	900	230	zimna • cold	2 468,00
<b>ADA120H</b>	1200	230	zimna • cold	2 878,00
<b>Seria ADA C - montaż do 2,5 m • ADA C series - assembly up to 2,5 m</b>				
<b>ADAC090</b>	900	230	zimna • cold	2 518,00
<b>ADAC120</b>	1200	230	zimna • cold	2 911,00
<b>Seria PA 2200C A/E/W - montaż do 2,2 m • PA2200C A/E/W series - assembly up to 2,2 m</b>				
<b>PA2210CA</b>	1050	230	zimna • cold	2 935,00
<b>PA2215CA</b>	1560	230	zimna • cold	3 878,00
<b>PA2220CA</b>	2050	230	zimna • cold	4 928,00
<b>PA2210CW</b>	1050	230	6,9	4 392,00
<b>PA2215CW</b>	1560	230	11,1	6 042,00
<b>PA2220CW</b>	2050	230	14,4	7 841,00
<b>PA2210CE03</b>	1050	230	3,0	4 328,00
<b>PA2210CE05</b>	1050	400	5,0	4 478,00
<b>PA2210CE08</b>	1050	400	8,0	4 842,00
<b>PA2215CE08</b>	1560	400	8,0	5 903,00
<b>PA2215CE12</b>	1560	400	12,0	6 020,00
<b>PA2220CE10</b>	2050	230	10,0	7 916,00
<b>PA2220CE16</b>	2050	230	16,0	8 484,00



Wyszczególnienie • Description	Szerokość • Width [mm]	Napięcie • Voltage [V]	Moc • Power [kW]	Cena [PLN/szt.] • Price [PLN/pc]
<b>Seria PA 2500 A/E/W</b> - montaż do 2,5 m • PA2500 A/E/W series - assembly up to 2,5 m				
PA2510E05	1050	400	5,0	5 148,00
PA2510E08	1050	400	8,0	5 478,00
PA2515E08	1560	400	8,0	7 084,00
PA2515E12	1560	400	12,0	7 289,00
PA2520E10	2050	400	10,0	9 384,00
PA2520E16	2050	400	16,0	9 862,00
PA2510W	1050	230	4,7	5 102,00
PA2515W	1560	230	9,2	6 924,00
PA2520W	2050	230	11,5	9 088,00
PA2510A	1050	230	zimna • cold	3 267,00
PA2515A	1560	230	zimna • cold	4 178,00
PA2520A	2050	230	zimna • cold	5 422,00
<b>Seria PA 3200C A/E/W</b> - montaż do 3,2 m • PA 3200C A/E/W series - assembly up to 3,2 m				
PA3210CA	1060	230	zimna • cold	5 895,00
PA3215CA	1570	230	zimna • cold	7 395,00
PA3220CA	2060	230	zimna • cold	9 824,00
PA3210CW	1060	230	8,0	7 503,00
PA3215CW	1570	230	14,0	9 219,00
PA3220CW	2060	230	18,0	12 415,00
PA3210CE08	1060	400	8,0	8 313,00
PA3215CE12	1570	400	12,0	9 986,00
PA3220CE16	2060	400	16,0	13 819,00



Wyszczególnienie • Description	Szerokość • Width [mm]	Napięcie • Voltage [V]	Moc • Power [kW]	Cena [PLN/szt.] • Price [PLN/pc]
<b>Seria PA 3500 A/E/W - montaż do 3,5 m • PA 3500 A/E/W series - assembly up to 3,5 m</b>				
<b>PA3510A</b>	1040	230	zimna • cold	7 779,00
<b>PA3515A</b>	1550	230	zimna • cold	9 229,00
<b>PA3520A</b>	2040	230	zimna • cold	11 280,00
<b>PA3525A</b>	2550	230	zimna • cold	14 769,00
<b>PA3510E08</b>	1040	400	8,0	9 665,00
<b>PA3515E12</b>	1550	400	12,0	11 763,00
<b>PA3520E16</b>	2040	400	16,0	14 734,00
<b>PA3525E20</b>	2550	400	20,0	18 718,00
<b>PA3510WH</b>	1040	230	11,0	9 288,00
<b>PA3515WH</b>	1550	230	16,0	11 363,00
<b>PA3520WH</b>	2040	230	21,0	13 814,00
<b>PA3525WH</b>	2550	230	29,0	17 963,00
<b>PA3510WL</b>	1040	230	22,0	9 288,00
<b>PA3515WL</b>	1550	230	33,0	11 363,00
<b>PA3520WL</b>	2040	230	42,0	13 814,00
<b>PA3525WL</b>	2550	230	59,0	17 963,00



Wyszczególnienie • Description	Szerokość • Width [mm]	Napięcie • Voltage [V]	Moc • Power [kW]	Cena [PLN/szt.] • Price [PLN/pc]
<b>Seria PA 4200 A/E/W - montaż do 4,2 m • PA 4200 A/E/W series - assembly up to 4,2 m</b>				
PA4210A	1040	230	zimna • cold	9 803,00
PA4215A	1550	230	zimna • cold	11 810,00
PA4220A	2040	230	zimna • cold	15 195,00
PA4225A	2550	230	zimna • cold	18 206,00
PA4210E12	1040	400	12,0	12 896,00
PA4215E18	1550	400	18,0	15 475,00
PA4220E24	2040	400	24,0	20 172,00
PA4225E30	2550	400	30,0	24 741,00
PA4210WH	1040	230	15,0	12 254,00
PA4215WH	1550	230	22,0	14 891,00
PA4220WH	2040	230	32,0	18 977,00
PA4225WH	2550	230	38,0	22 594,00
PA4210WL	1040	230	31,0	12 254,00
PA4215WL	1550	230	45,0	14 891,00
PA4220WL	2040	230	64,0	18 977,00
PA4225WL	2550	230	79,0	22 594,00

**Akcesoria dla serii PA • Accessories for the product line PA**

Wyszczególnienie • Description	Typ • Type	Cena [PLN/szt.] • Price [PLN/pc]
<b>Podstawowe sterowanie cyfrowe</b> • Basic digital control	SIReBN Basic	508,00
<b>Rozszerzone sterowanie cyfrowe</b> • Extended digital control	SIReACZ	1 286,00
<b>Rozszerzone sterowanie cyfrowe</b> • Extended digital control	SIReAAZ	2 148,00
<b>Zewnętrzny czujnik temperatury pom.,</b> • Room external temperature sensor	SIReRTX	123,00
<b>Zestaw do zabudowy</b> • Installation kit	SIReUR	123,00
<b>Czujnik przylgowy temperatury wody</b> • Sensor water temperature	SIReWTA	565,00
<b>Zawór 2-drogowy z siłownikiem</b> • Two-way valve with actuator	FHDN20	363,00



## Kurtyna standardowa • Standard air curtain

## GUARD



Model	Wydajność powietrza • Efficiency [m <sup>3</sup> /h]	Długość • Width [mm]	Napięcie • Voltage [V]	Moc silnika • Motor power [kW]	Cena [PLN/szt.] • Price [PLN/pc]
<b>GUARD 100W</b>	1050	1000	230/50	6-10	1 899,00
<b>GUARD 150W</b>	1550	1500	230/50	10-18	2 349,00
<b>GUARD 200W</b>	2100	2000	230/50	15-25	2 799,00
<b>GUARD 100E</b>	1250	1000	400/50	3-6	1 939,00
<b>GUARD 150E</b>	1800	1500	400/50	6-9	2 389,00
<b>GUARD 200E</b>	2550	2000	400/50	9-12	2 949,00
<b>GUARD 100C</b>	1300	1000	230/50	-	1 549,00
<b>GUARD 150C</b>	1800	1500	230/50	-	1 999,00
<b>GUARD 200C</b>	2650	2000	230/50	-	2 449,00

## Kurtyna przemysłowa • Industrial air curtain

## GUARD PRO



Model	Wydajność powietrza • Efficiency [m <sup>3</sup> /h]	Długość • Width [mm]	Moc • Motor power [kW]	Cena [PLN/szt.] • Price [PLN/pc]
<b>GUARD PRO 150W</b>	6500	1500	25	3 899,00
<b>GUARD PRO 200W</b>	9000	2000	38	5 049,00
<b>GUARD PRO 150E</b>	6700	1500	12	4 469,00
<b>GUARD PRO 200E</b>	9100	2000	18	5 799,00
<b>GUARD PRO 150C</b>	6800	1500	-	3 449,00
<b>GUARD PRO 200C</b>	9200	2000	-	4 549,00



## Klapa przeciwpożarowa motylkowa okrągła • Round fire damper

FBC



### Klapa przeciwpożarowa motylkowa okrągła FBC

Typ • Type	Cena [PLN/szt.] • Price [PLN/pc]			
	ø100	ø125	ø160	ø200
<b>FBC1-S0</b> EI60S, bez mikroprzełączników • EI60S, no microswitches	106,00	118,00	139,00	166,00
<b>FBC1-S1</b> EI60S, jeden mikroprzełącznik • EI60S, one microswitch	135,00	146,00	167,00	194,00
<b>FBC7-S0</b> EI120S, bez mikroprzełączników • EI120S, no microswitches	132,00	152,00	170,00	215,00
<b>FBC7-S1</b> EI120S, jeden mikroprzełącznik • EI120S, one microswitch	160,00	181,00	198,00	244,00

#### Dodatkowo na zamówienie:

- klapy wyposażone w zawór powietrzny,
- klapy wyposażone w zawór powietrzny i mikroprzełącznik,
- klapy w odporności EI90S - we wszystkich powyższych rozmiarach i konfiguracjach.



## Klapa przeciwpożarowa okrągła - Round fire damper

WH



WH25



WH45

### Klapa przeciwpożarowa okrągła WH25

Średnica - Diameter [mm]	Cena [PLN/szt.] - Price [PLN/pc]			
	WH25C-S0-M0	WH25C-S2-M0	WH25VSB	WH25DSB
100	279,00	346,00	1 314,00	1 387,00
125	290,00	358,00	1 326,00	1 399,00
140	293,00	361,00	1 329,00	1 402,00
150	298,00	364,00	1 332,00	1 405,00
160	308,00	375,00	1 345,00	1 418,00
180	313,00	382,00	1 351,00	1 424,00
200	325,00	395,00	1 364,00	1 437,00
224	333,00	404,00	1 372,00	1 446,00
250	350,00	422,00	1 391,00	1 464,00
280	361,00	434,00	1 402,00	1 475,00
300	369,00	442,00	1 390,00	1 463,00
315	385,00	460,00	1 428,00	1 502,00

### Klapa przeciwpożarowa okrągła WH45

Średnica - Diameter [mm]	Cena [PLN/szt.] - Price [PLN/pc]			
	WH45B-S0-M0	WH45B-S2-M0	WH45VMB	WH45DMB
355	648,00	745,00	1 726,00	1 812,00
400	707,00	804,00	1 777,00	1 863,00
450	755,00	852,00	1 823,00	1 909,00
500	769,00	866,00	1 834,00	1 920,00
560	833,00	930,00	1 890,00	1 977,00
600	880,00	977,00	1 930,00	2 016,00
630	919,00	1 016,00	1 964,00	2 050,00
710	1 035,00	1 132,00	2 301,00 *	2 502,00 **
800	1 155,00	1 252,00	2 405,00 *	2 607,00 **

**B** - wersja Basic

**C** - wersja Compact

**M0** - bez elektromagnesu

**S0** - bez mikroprzełączników wskazujących pozycję

**S2** - z dwoma mikroprzełącznikami wskazującymi pozycję

**VSB** - z siłownikiem Belimo BFL24T

**DSB** - z siłownikiem Belimo BFL230T

**VMB** - z siłownikiem Belimo BFN24T

\* WH45VGB - z siłownikiem Belimo BF24T

**DMB** - z siłownikiem Belimo BFN230T

\*\* WH45DGB - z siłownikiem Belimo BF230T





## Klapa przeciwpożarowa prostokątna - Rectangular fire damper

**WK25**



### Klapa przeciwpożarowa prostokątna WK25C-S0-M0

Szerokość • Width [mm]	Cena [PLN/szt.] • Price [PLN/pc]				
	Wysokość • Height [mm]				
	200	300	400	500	600
100	415,00	444,00	472,00	502,00	532,00
200	450,00	481,00	515,00	550,00	580,00
300	479,00	513,00	552,00	589,00	624,00
400	512,00	551,00	593,00	635,00	674,00
500	541,00	584,00	630,00	675,00	718,00
600	571,00	617,00	668,00	718,00	765,00
700	600,00	650,00	705,00	759,00	822,00
800	630,00	685,00	743,00	814,00	869,00

### Klapa przeciwpożarowa prostokątna WK25C-S2-M0

Szerokość • Width [mm]	Cena [PLN/szt.] • Price [PLN/pc]				
	Wysokość • Height [mm]				
	200	300	400	500	600
100	489,00	518,00	548,00	578,00	609,00
200	525,00	557,00	592,00	628,00	660,00
300	555,00	591,00	631,00	669,00	706,00
400	590,00	630,00	673,00	717,00	758,00
500	619,00	663,00	711,00	759,00	803,00
600	650,00	698,00	750,00	802,00	851,00
700	680,00	733,00	789,00	844,00	910,00
800	712,00	768,00	828,00	902,00	959,00

C - wersja Compact  
M0 - bez elektromagnesu

S0 - bez mikroprzełączników wskazujących pozycję  
S2 - z dwoma mikroprzełącznikami wskazującymi pozycję



## Klapa przeciwpożarowa prostokątna - Rectangular fire damper

**WK25**



### Klapa przeciwpożarowa prostokątna WK25VSB

Szerokość • Width [mm]	Cena [PLN/szt.] • Price [PLN/pc]				
	Wysokość • Height [mm]				
	200	300	400	500	600
100	1 382,00	1 410,00	1 437,00	1 467,00	1 496,00
200	1 416,00	1 447,00	1 480,00	1 514,00	1 545,00
300	1 445,00	1 479,00	1 517,00	1 554,00	1 589,00
400	1 478,00	1 516,00	1 558,00	1 600,00	1 638,00
500	1 506,00	1 548,00	1 594,00	1 640,00	1 682,00
600	1 536,00	1 582,00	1 632,00	1 682,00	1 728,00
700	1 565,00	1 615,00	1 669,00	1 722,00	1 785,00
800	1 594,00	1 649,00	1 706,00	1 777,00	1 832,00

### Klapa przeciwpożarowa prostokątna WK25DSB

Szerokość • Width [mm]	Cena [PLN/szt.] • Price [PLN/pc]				
	Wysokość • Height [mm]				
	200	300	400	500	600
100	1 459,00	1 487,00	1 514,00	1 543,00	1 573,00
200	1 493,00	1 523,00	1 557,00	1 591,00	1 621,00
300	1 521,00	1 555,00	1 594,00	1 631,00	1 666,00
400	1 554,00	1 593,00	1 634,00	1 676,00	1 714,00
500	1 582,00	1 625,00	1 671,00	1 716,00	1 759,00
600	1 612,00	1 659,00	1 709,00	1 758,00	1 805,00
700	1 641,00	1 692,00	1 745,00	1 799,00	1 862,00
800	1 671,00	1 725,00	1 783,00	1 854,00	1 909,00

VSB - z silownikiem Belimo BFL24T

DSB - z silownikiem Belimo BFL230T



## Klapa przeciwpożarowa prostokątna - Rectangular fire damper

**WK45**



### Klapa przeciwpożarowa prostokątna WK45B-S0-M0

Szerokość • Width [mm]	Cena [PLN/szt.] • Price [PLN/pc]						
	Wysokość • Height [mm]						
	200	300	400	500	600	700	800
<b>200</b>	494,00	528,00	558,00	600,00	638,00	×	×
<b>300</b>	531,00	568,00	605,00	650,00	693,00	740,00	×
<b>400</b>	572,00	614,00	655,00	706,00	753,00	804,00	851,00
<b>500</b>	609,00	656,00	701,00	757,00	809,00	865,00	929,00
<b>600</b>	647,00	698,00	748,00	810,00	866,00	941,00	996,00
<b>700</b>	684,00	740,00	795,00	860,00	935,00	1 001,00	1 061,00
<b>800</b>	712,00	772,00	847,00	931,00	998,00	1 069,00	1 133,00
<b>900</b>	748,00	814,00	906,00	981,00	1 053,00	1 129,00	1 199,00
<b>1000</b>	788,00	871,00	956,00	1 035,00	1 112,00	1 192,00	1 266,00
<b>1100</b>	839,00	915,00	1 004,00	1 088,00	1 169,00	1 255,00	1 334,00
<b>1200</b>	876,00	956,00	1 050,00	1 139,00	1 226,00	1 315,00	1 399,00
<b>1300</b>	913,00	997,00	1 096,00	1 190,00	1 281,00	1 375,00	1 464,00
<b>1400</b>	954,00	1 044,00	1 148,00	1 246,00	1 342,00	1 442,00	1 534,00
<b>1500</b>	991,00	1 085,00	1 193,00	1 297,00	1 398,00	1 502,00	1 600,00

**B** - wersja Basic

**M0** - bez elektromagnesu

**S0** - bez mikroprzełączników wskazujących pozycję



## Klapa przeciwpożarowa prostokątna - Rectangular fire damper

**WK45**



### Klapa przeciwpożarowa prostokątna WK45B-SA-M0

Szerokość • Width [mm]	Cena [PLN/szt.] • Price [PLN/pc]						
	Wysokość • Height [mm]						
	200	300	400	500	600	700	800
<b>200</b>	541,00	575,00	606,00	647,00	686,00	×	×
<b>300</b>	579,00	616,00	653,00	698,00	742,00	788,00	×
<b>400</b>	620,00	662,00	704,00	754,00	802,00	854,00	900,00
<b>500</b>	657,00	704,00	749,00	805,00	858,00	915,00	979,00
<b>600</b>	695,00	747,00	797,00	858,00	916,00	991,00	1 047,00
<b>700</b>	732,00	789,00	844,00	909,00	985,00	1 051,00	1 112,00
<b>800</b>	761,00	821,00	897,00	981,00	1 049,00	1 120,00	1 185,00
<b>900</b>	797,00	863,00	956,00	1 032,00	1 104,00	1 180,00	1 250,00
<b>1000</b>	837,00	921,00	1 006,00	1 086,00	1 163,00	1 244,00	1 319,00
<b>1100</b>	889,00	965,00	1 055,00	1 139,00	1 221,00	1 307,00	1 387,00
<b>1200</b>	925,00	1 006,00	1 101,00	1 191,00	1 278,00	1 368,00	1 452,00
<b>1300</b>	962,00	1 048,00	1 148,00	1 242,00	1 334,00	1 428,00	1 518,00
<b>1400</b>	1 004,00	1 095,00	1 200,00	1 298,00	1 395,00	1 495,00	1 589,00
<b>1500</b>	1 042,00	1 136,00	1 245,00	1 350,00	1 451,00	1 556,00	1 654,00

**B** - manualna  
**M0** - bez elektromagnesu

**SA** - z mikroprzełącznikiem otwartej klapki



## Klapa przeciwpożarowa prostokątna - Rectangular fire damper

**WK45**



### Klapa przeciwpożarowa prostokątna WK45VMB

Szerokość • Width [mm]	Cena [PLN/szt.] • Price [PLN/pc]						
	Wysokość • Height [mm]						
	200	300	400	500	600	700	800
<b>200</b>	1 635,00	1 667,00	1 707,00	1 747,00	1 784,00	×	×
<b>300</b>	1 671,00	1 707,00	1 752,00	1 797,00	1 838,00	1 883,00	×
<b>400</b>	1 711,00	1 752,00	1 802,00	1 851,00	1 897,00	1 947,00	1 992,00
<b>500</b>	1 747,00	1 791,00	1 846,00	1 901,00	1 952,00	2 007,00	2 069,00
<b>600</b>	1 783,00	1 834,00	1 892,00	1 952,00	2 008,00	2 080,00	2 135,00
<b>700</b>	1 818,00	1 874,00	1 937,00	2 001,00	2 075,00	2 140,00	2 199,00
<b>800</b>	1 856,00	1 915,00	1 984,00	2 066,00	2 131,00	2 201,00	2 265,00
<b>900</b>	1 891,00	1 956,00	2 042,00	2 116,00	2 186,00	2 259,00	2 328,00
<b>1000</b>	1 930,00	2 012,00	2 090,00	2 169,00	2 244,00	2 323,00	2 654,00 *
<b>1100</b>	1 980,00	2 053,00	2 137,00	2 220,00	2 300,00	2 384,00	2 720,00 *
<b>1200</b>	2 015,00	2 094,00	2 181,00	2 270,00	2 354,00	2 701,00 *	2 784,00 *
<b>1300</b>	2 050,00	2 135,00	2 227,00	2 320,00	2 409,00	2 761,00 *	2 848,00 *
<b>1400</b>	2 092,00	2 180,00	2 277,00	2 375,00	2 727,00 *	2 825,00 *	2 918,00 *
<b>1500</b>	2 127,00	2 220,00	2 322,00	2 425,00	2 781,00 *	2 884,00 *	2 981,00 *

VMB - z silownikiem Belimo BFN24T

\* WK45VGB - z silownikiem Belimo BF24T



## Klapa przeciwpożarowa prostokątna - Rectangular fire damper

**WK45**



### Klapa przeciwpożarowa prostokątna WK45DMB

Szerokość • Width [mm]	Cena [PLN/szt.] • Price [PLN/pc]						
	Wysokość • Height [mm]						
	200	300	400	500	600	700	800
<b>200</b>	1 721,00	1 752,00	1 792,00	1 833,00	1 869,00	×	×
<b>300</b>	1 756,00	1 792,00	1 837,00	1 882,00	1 923,00	1 969,00	×
<b>400</b>	1 797,00	1 837,00	1 887,00	1 937,00	1 983,00	2 033,00	2 077,00
<b>500</b>	1 832,00	1 878,00	1 932,00	1 986,00	2 037,00	2 092,00	2 154,00
<b>600</b>	1 868,00	1 919,00	1 978,00	2 037,00	2 093,00	2 166,00	2 221,00
<b>700</b>	1 905,00	1 959,00	2 023,00	2 087,00	2 161,00	2 225,00	2 284,00
<b>800</b>	1 941,00	2 000,00	2 069,00	2 151,00	2 217,00	2 286,00	2 350,00
<b>900</b>	1 976,00	2 041,00	2 127,00	2 201,00	2 272,00	2 346,00	2 413,00
<b>1000</b>	2 015,00	2 097,00	2 175,00	2 254,00	2 329,00	2 408,00	2 844,00 *
<b>1100</b>	2 065,00	2 140,00	2 223,00	2 306,00	2 385,00	2 469,00	2 909,00 *
<b>1200</b>	2 101,00	2 179,00	2 268,00	2 355,00	2 440,00	2 891,00 *	2 973,00 *
<b>1300</b>	2 137,00	2 220,00	2 312,00	2 405,00	2 494,00	2 950,00 *	3 037,00 *
<b>1400</b>	2 177,00	2 266,00	2 362,00	2 460,00	2 917,00 *	3 014,00 *	3 107,00 *
<b>1500</b>	2 213,00	2 305,00	2 408,00	2 510,00	2 972,00 *	3 074,00 *	3 170,00 *

DMB - z silownikiem Belimo BFN230T

\* WK45DGB - z silownikiem Belimo BF230T

# KLAPY PRZECIWOPOŻAROWE

Klapy przeciwpożarowe okrągłe SMAY • SMAY round fire dampers



## Kłapa przeciwpożarowa okrągła, napęd sprężynowy

• Round fire damper, mainspring powered

KTS-O-S



Średnica [mm] • Diameter [mm]	160	200	250	315	355	400	450	500	630
Cena [PLN/szt.] • Price [PLN/pc]	410,36	434,48	460,87	543,18	572,93	614,24	654,91	729,64	848,30

## Kłapa przeciwpożarowa okrągła, napęd silownikiem 24V

• Round fire damper, 24 V electric actuator drive

KTS-O-E 24V



Średnica [mm] • Diameter [mm]	160	200	250	315	355	400	450	500	630
Cena [PLN/szt.] • Price [PLN/pc]	1 119,56	1 138,82	1 159,91	1 221,99	1 244,60	1 275,21	1 596,00	1 653,87	1 745,06

## Kłapa przeciwpożarowa okrągła, napęd silownikiem 230V

• Round fire damper, 230 V electric actuator drive

KTS-O-E 230V



Średnica [mm] • Diameter [mm]	160	200	250	315	355	400	450	500	630
Cena [PLN/szt.] • Price [PLN/pc]	1 196,17	1 214,42	1 235,51	1 297,60	1 320,20	1 350,81	1 677,67	1 735,53	1 826,72

Opcja • Option:

dopłata dla krańcówki w położeniu "zamknięta" • extra charge for a limit switch in the „close” position: + 95,00 PLN

dopłata dla krańcówki w położeniu "otwarta" • extra charge for a limit switch in the „open” position: + 95,00 PLN

## Klapa przeciwpożarowa, napęd sprężynowy

• Fire damper, mainspring powered

KTM-M



Średnica • Diameter [mm]	<b>100</b>	<b>125</b>	<b>160</b>	<b>200</b>	<b>250</b>
Cena [PLN/szt.] • Price [PLN/pc]	149,45	160,26	193,96	214,86	240,03

## Klapa przeciwpożarowa, napęd silownikiem 24V

• Fire damper, 24 V electric actuator drive

KTM-E 24V



Średnica • Diameter [mm]	<b>100</b>	<b>125</b>	<b>160</b>	<b>200</b>	<b>250</b>
Cena [PLN/szt.] • Price [PLN/pc]	972,61	982,70	1 001,52	1 015,77	1 036,98

## Klapa przeciwpożarowa, napęd silownikiem 230V

• Fire damper, 230 V electric actuator drive

KTM-E 230V



Średnica • Diameter [mm]	<b>100</b>	<b>125</b>	<b>160</b>	<b>200</b>	<b>250</b>
Cena [PLN/szt.] • Price [PLN/pc]	1 045,30	1 055,39	1 074,11	1 088,46	1 109,68

Opcja • Option:

dopłata dla krańcówki w położeniu "zamknięta" • extra charge for a limit switch in the „close” position: **+ 75,00 PLN**

dopłata dla krańcówki w położeniu "otwarta" • extra charge for a limit switch in the „open” position: **+ 75,00 PLN**



# KLAPY PRZECIWPÓŻAROWE

Klapy przeciwpożarowe prostokątne SMAY • SMAY rectangular fire dampers



**Kłapa przeciwpożarowa odcinająca prostokątna**  
• Cut off rectangular fire damper

**KWP-OS-350-W0**



Wysokość • Height [mm]	Cena [PLN/szt.] • Price [PLN/pc]							
	Szerokość • Width [mm]							
	200	250	300	350	400	450	500	550
200	560,35	582,19	604,03	625,87	648,34	669,55	691,29	713,13
250	580,42	604,14	627,95	651,66	676,10	699,19	722,90	746,62
300	600,50	626,18	651,87	677,56	703,77	728,83	754,42	780,10
350	622,23	649,79	677,35	705,02	733,20	760,14	787,59	815,15
400	642,30	671,74	701,27	730,81	760,86	789,78	819,21	848,64
450	662,38	693,78	725,19	756,60	788,63	819,42	850,72	882,13
500	×	716,98	750,36	783,64	817,65	850,30	883,58	916,86
550	×	717,50	752,65	787,90	823,78	858,42	893,57	928,72
600	×	739,44	776,57	813,80	851,55	888,06	925,08	962,21
700	×	×	824,41	865,38	906,98	947,34	988,21	1 029,18
800	×	×	×	917,59	962,94	1 007,14	1 051,86	1 145,87

Wysokość • Height [mm]	Cena [PLN/szt.] • Price [PLN/pc]							
	Szerokość • Width [mm]							
	600	650	700	750	800	900	950	1000
200	734,86	756,70	778,44	800,28	823,68	845,73	867,46	889,51
250	770,33	794,04	817,65	841,36	866,74	892,53	916,24	940,16
300	805,69	831,27	856,96	882,54	909,79	939,43	965,02	990,81
350	842,71	870,17	897,73	925,29	954,41	987,90	1 015,46	1 043,12
400	878,07	907,50	936,94	966,37	997,46	1 034,80	1 064,23	1 093,87
450	913,43	944,84	976,14	1 007,55	1 040,52	1 130,90	1 162,20	1 193,82
500	950,04	983,32	1 016,60	1 049,88	1 084,72	1 178,94	1 212,22	1 245,71
550	963,87	999,02	1 034,28	1 118,73	1 155,44	1 225,85	1 261,00	1 296,36
600	999,34	1 036,36	1 122,68	1 159,81	1 198,50	1 272,65	1 309,78	1 347,11
700	1 119,35	1 160,22	1 201,10	1 242,07	1 284,61	1 366,46	1 407,33	1 448,51
800	1 190,59	1 235,31	1 280,03	1 324,86	1 371,14	1 460,68	1 505,40	1 550,33

Opcja • Option:

dopłata dla krańcówki w położeniu "zamknięta" • extra charge for a limit switch in the „close” position: **+ 60,00 PLN**

dopłata dla krańcówki w położeniu "otwarta" • extra charge for a limit switch in the „open” position: **+ 60,00 PLN**

# KLAPY PRZECIWOŻAROWE

Klapy przeciwpożarowe prostokątne SMAY • SMAY rectangular fire dampers



**Kłapa przeciwpożarowa odcinająca prostokątna EIS 120**  
• Cut off rectangular fire damper EIS 120

**KWP-LS-350-W0**



Wysokość • Height [mm]	Cena [PLN/szt.] • Price [PLN/pc]						
	Szerokość • Width [mm]						
	200	250	300	350	400	450	500
200	446,89	466,13	485,26	504,50	523,74	542,98	562,22
250	466,13	486,41	506,69	526,97	547,25	567,53	587,81
300	485,26	506,69	528,01	549,43	570,75	592,18	613,50
350	504,50	526,97	549,43	571,90	594,26	616,72	639,18
400	523,74	547,25	570,75	594,26	617,86	641,37	664,87
450	×	567,53	592,18	616,72	641,37	665,91	690,56
500	×	587,81	613,50	639,18	664,87	690,56	716,25

Wysokość • Height [mm]	Cena [PLN/szt.] • Price [PLN/pc]					
	Szerokość • Width [mm]					
	550	600	650	700	750	800
200	581,36	600,60	619,84	639,08	658,22	677,46
250	608,19	628,47	648,75	669,03	689,31	709,59
300	634,92	656,24	677,66	698,98	720,30	741,73
350	661,65	684,11	706,58	728,94	751,30	773,86
400	688,38	711,88	735,38	758,99	782,59	806,00
450	715,10	739,75	764,30	788,94	813,53	838,14
500	741,94	767,52	793,21	818,90	844,48	870,27

Opcja • Option:

dopłata dla krańcówki w położeniu "zamknięta" • extra charge for a limit switch in the „close” position: + 82,00 PLN  
dopłata dla krańcówki w położeniu "otwarta" • extra charge for a limit switch in the „open” position: + 82,00 PLN

# KLAPY PRZECIWOŻAROWE

Klapy przeciwpożarowe prostokątne SMAY • SMAY rectangular fire dampers



**Kłapa przeciwpożarowa odcinająca prostokątna EIS 120**  
• Cut off rectangular fire damper EIS 120

**KWP-LE-350-BLF24-T**



Wysokość • Height [mm]	Cena [PLN/szt.] • Price [PLN/pc]						
	Szerokość • Width [mm]						
	200	250	300	350	400	450	500
200	1 126,84	1 144,10	1 161,47	1 178,74	1 196,10	1 213,37	1 230,74
250	1 144,10	1 162,41	1 180,71	1 199,02	1 217,32	1 235,62	1 253,93
300	1 161,47	1 180,71	1 199,95	1 219,19	1 238,54	1 257,78	1 277,02
350	1 178,74	1 199,02	1 219,19	1 239,47	1 259,75	1 279,93	1 300,21
400	1 196,10	1 217,32	1 238,54	1 259,75	1 280,86	1 302,08	1 323,30
450	×	1 235,62	1 257,78	1 279,93	1 302,08	1 324,23	1 346,49
500	×	1 253,93	1 277,02	1 300,21	1 323,30	1 346,49	1 649,23

Wysokość • Height [mm]	Cena [PLN/szt.] • Price [PLN/pc]					
	Szerokość • Width [mm]					
	550	600	650	700	750	800
200	1 248,10	1 265,37	1 282,74	1 300,00	1 317,37	1 334,63
250	1 272,13	1 290,43	1 308,74	1 327,04	1 345,34	1 363,65
300	1 296,26	1 315,50	1 334,84	1 354,08	1 373,32	1 392,56
350	1 320,38	1 340,66	1 360,84	1 660,67	1 680,95	1 701,13
400	1 344,51	1 365,73	1 666,50	1 687,71	1 708,93	1 730,14
450	1 648,19	1 670,45	1 692,60	1 714,75	1 736,90	1 759,06
500	1 672,32	1 695,51	1 718,60	1 741,79	1 764,88	1 788,07

# KLAPY PRZECIWOŻAROWE

Klapy przeciwpożarowe prostokątne SMAY • SMAY rectangular fire dampers



**Kłapa przeciwpożarowa odcinająca prostokątna EIS 120**  
• Cut off rectangular fire damper EIS 120

**KWP-LE-350-BLF230-T**



Wysokość • Height [mm]	Cena [PLN/szt.] • Price [PLN/pc]						
	Szerokość • Width [mm]						
	200	250	300	350	400	450	500
<b>200</b>	1 199,54	1 216,80	1 234,17	1 251,43	1 268,80	1 286,06	1 303,43
<b>250</b>	1 216,80	1 235,10	1 253,41	1 271,71	1 290,02	1 308,32	1 326,52
<b>300</b>	1 234,17	1 253,41	1 272,65	1 291,89	1 311,23	1 330,47	1 349,71
<b>350</b>	1 251,43	1 271,71	1 291,89	1 312,17	1 332,34	1 352,62	1 372,80
<b>400</b>	1 268,80	1 290,02	1 311,23	1 332,34	1 353,56	1 374,78	1 395,99
<b>450</b>	×	1 308,32	1 330,47	1 352,62	1 374,78	1 396,93	1 419,18
<b>500</b>	×	1 326,52	1 349,71	1 372,80	1 395,99	1 419,18	1 727,75

Wysokość • Height [mm]	Cena [PLN/szt.] • Price [PLN/pc]					
	Szerokość • Width [mm]					
	550	600	650	700	750	800
<b>200</b>	1 320,70	1 338,06	1 355,43	1 372,70	1 390,06	1 407,33
<b>250</b>	1 344,82	1 363,13	1 381,43	1 399,74	1 418,04	1 436,34
<b>300</b>	1 368,95	1 388,19	1 407,54	1 426,78	1 446,02	1 465,26
<b>350</b>	1 393,08	1 413,36	1 433,54	1 739,30	1 759,47	1 779,75
<b>400</b>	1 417,21	1 438,42	1 745,12	1 766,23	1 787,45	1 808,66
<b>450</b>	1 726,82	1 748,97	1 771,12	1 793,27	1 815,42	1 837,68
<b>500</b>	1 750,94	1 774,03	1 797,22	1 820,31	1 843,50	1 866,59

# KLAPY PRZECIWPOŻAROWE

Klapy przeciwpożarowe okrągłe Mercor • Mercor round fire dampers



Klapa przeciwpożarowa • Fire damper EIS 120		MCR FID PRO						
Typ • Type	Cena [PLN/szt.] • Price [PLN/pc]							
	Średnica • Diameter [mm]							
	100	125	150	160	200	250	300	315
<b>RST</b> SPRĘŻYNA Z TOPIKIEM • MAINSPRING POWERED	140,00	147,00	155,00	157,00	170,00	456,00	485,00	504,00
<b>RST + WK1</b> SPRĘŻYNA Z TOPIKIEM + 1 KRAŃCÓWKA • MAINSPRING POWERED + ONE MICROSWITCH	145,00	152,00	160,00	162,00	175,00	461,00	490,00	509,00
<b>RST + WK2</b> SPRĘŻYNA Z TOPIKIEM + 2 KRAŃCÓWKI • MAINSPRING POWERED + TWO MICROSWITCHES	149,00	156,00	164,00	166,00	179,00	465,00	494,00	513,00
<b>BELIMO 24T</b> SIŁOWNIK • ACTUATOR	819,00	825,00	834,00	836,00	849,00	1 135,00	1 164,00	1 183,00
<b>BELIMO 230T</b> SIŁOWNIK • ACTUATOR	879,00	886,00	894,00	896,00	909,00	1 195,00	1 224,00	1 243,00



**Klapa przeciwpożarowa odcinająca prostokątna,  
z wyzwalaczem termicznym 72°C, EIS 120**  
• Cut off rectangular fire damper, with 72°C thermal release, EIS 120

**MCR-FIDS-c/P RST**

Wysokość • Height [mm]	Cena [PLN/szt.] • Price [PLN/pc]				
	Szerokość • Width [mm]				
	200	300	400	500	600
<b>200</b>	545,00	566,00	591,00	621,00	646,00
<b>300</b>	563,00	588,00	609,00	643,00	671,00
<b>400</b>	578,00	609,00	628,00	671,00	699,00
<b>500</b>	730,00	748,00	767,00	788,00	806,00
<b>600</b>	745,00	767,00	785,00	806,00	825,00
<b>700</b>	763,00	782,00	803,00	825,00	847,00
<b>800</b>	779,00	800,00	822,00	844,00	865,00

Wysokość • Height [mm]	Cena [PLN/szt.] • Price [PLN/pc]			
	Szerokość • Width [mm]			
	700	800	900	1000
<b>200</b>	671,00	696,00	794,00	813,00
<b>300</b>	696,00	720,00	819,00	834,00
<b>400</b>	720,00	745,00	841,00	859,00
<b>500</b>	825,00	844,00	862,00	881,00
<b>600</b>	847,00	865,00	887,00	905,00
<b>700</b>	865,00	887,00	908,00	930,00
<b>800</b>	887,00	908,00	930,00	952,00

Pozostałe wymiary na zapytanie.

# KLAPY PRZECIWPÓŻAROWE

Klapy przeciwpożarowe prostokątne Mercor • Mercor rectangular fire dampers



**Klapa przeciwpożarowa odcinająca prostokątna,  
z siłownikiem 24V i wyzwalaczem termicznym 72°C, EIS 120**  
• Cut off rectangular fire damper, with 24V actuator and 72°C thermal release, EIS 120

**MCR-FIDS-c/P  
BFL24T**

Wysokość • Height [mm]	Cena [PLN/szt.] • Price [PLN/pc]				
	Szerokość • Width [mm]				
	200	300	400	500	600
<b>200</b>	1 127,00	1 148,00	1 173,00	1 203,00	1 228,00
<b>300</b>	1 145,00	1 170,00	1 191,00	1 225,00	1 253,00
<b>400</b>	1 160,00	1 191,00	1 210,00	1 253,00	1 281,00
<b>500</b>	1 312,00	1 330,00	1 349,00	1 370,00	1 388,00
<b>600</b>	1 327,00	1 349,00	1 367,00	1 388,00	1 407,00
<b>700</b>	1 345,00	1 364,00	1 385,00	1 407,00	1 429,00
<b>800</b>	1 361,00	1 382,00	1 404,00	1 426,00	1 447,00

Wysokość • Height [mm]	Cena [PLN/szt.] • Price [PLN/pc]			
	Szerokość • Width [mm]			
	700	800	900	1000
<b>200</b>	1 253,00	1 278,00	1 376,00	1 395,00
<b>300</b>	1 278,00	1 302,00	1 401,00	1 416,00
<b>400</b>	1 302,00	1 327,00	1 423,00	1 441,00
<b>500</b>	1 407,00	1 426,00	1 444,00	1 463,00
<b>600</b>	1 429,00	1 447,00	1 469,00	1 720,00
<b>700</b>	1 447,00	1 469,00	1 723,00	1 745,00
<b>800</b>	1 469,00	1 723,00	1 745,00	1 767,00

Pozostałe wymiary na zapytanie.



**Klapa przeciwpożarowa odcinająca prostokątna,  
z siłownikiem 230V i wyłączaczem termicznym 72°C, EIS 120**  
• Cut off rectangular fire damper, with 230V actuator and 72°C thermal release, EIS 120

**MCR-FIDS-c/P  
BFL230T**

Wysokość • Height [mm]	Cena [PLN/szt.] • Price [PLN/pc]				
	Szerokość • Width [mm]				
	200	300	400	500	600
<b>200</b>	1 187,00	1 208,00	1 233,00	1 263,00	1 288,00
<b>300</b>	1 205,00	1 230,00	1 251,00	1 285,00	1 313,00
<b>400</b>	1 220,00	1 251,00	1 270,00	1 313,00	1 341,00
<b>500</b>	1 372,00	1 390,00	1 409,00	1 430,00	1 448,00
<b>600</b>	1 387,00	1 409,00	1 427,00	1 448,00	1 467,00
<b>700</b>	1 405,00	1 424,00	1 445,00	1 467,00	1 489,00
<b>800</b>	1 421,00	1 442,00	1 464,00	1 486,00	1 507,00

Wysokość • Height [mm]	Cena [PLN/szt.] • Price [PLN/pc]			
	Szerokość • Width [mm]			
	700	800	900	1000
<b>200</b>	1 313,00	1 338,00	1 436,00	1 455,00
<b>300</b>	1 338,00	1 362,00	1 461,00	1 476,00
<b>400</b>	1 362,00	1 387,00	1 483,00	1 501,00
<b>500</b>	1 467,00	1 486,00	1 504,00	1 523,00
<b>600</b>	1 489,00	1 561,00	1 529,00	1 786,00
<b>700</b>	1 507,00	1 529,00	1 789,00	1 811,00
<b>800</b>	1 529,00	1 789,00	1 811,00	1 833,00

Pozostałe wymiary na zapytanie.





## Siłownik do przepustnic bez sprężyny powrotnej • Actuator for dampers without return spring



2 Nm	Cena [PLN/szt.] • Price [PLN/pc]
DA02N24	260,00
DA02N24S	280,00
DA02N24PI	310,00
DA02N24PIS	330,00
DA02N220	320,00
DA02N220S	305,00
DA02N220PI	370,00
DA02N220PIS	380,00

4 Nm	Cena [PLN/szt.] • Price [PLN/pc]
DA04N24	350,00
DA04N24S	370,00
DA04N24PI	430,00
DA04N24PIS	430,00
DA04N220	400,00
DA04N220S	440,00
DA04N220PI	480,00
DA04N220PIS	500,00



8 Nm	Cena [PLN/szt.] • Price [PLN/pc]
DA08N24	450,00
DA08N24S	500,00
DA08N24PI	530,00
DA08N24PIS	590,00
DA08N220	470,00
DA08N220S	510,00
DA08N220PI	580,00
DA08N220PIS	690,00

16 Nm	Cena [PLN/szt.] • Price [PLN/pc]
DA16N24	540,00
DA16N24S	600,00
DA16N24PI	620,00
DA16N24PIS	710,00
DA16N220	550,00
DA16N220S	610,00
DA16N220PI	680,00
DA16N220PIS	800,00

**Siłownik do przepustnic bez sprężyny powrotnej • Actuator for dampers without return spring**

24 Nm	Cena [PLN/szt.] • Price [PLN/pc]
DA24N24	630,00
DA24N24S	700,00
DA24N24PI	740,00
DA24N24PIS	830,00
DA24N220	650,00
DA24N220S	720,00
DA24N220PI	800,00
DA24N220PIS	960,00

32 Nm	Cena [PLN/szt.] • Price [PLN/pc]
DA32N24	720,00
DA32N24S	800,00
DA32N24PI	880,00
DA32N24PIS	980,00
DA32N220	740,00
DA32N220S	840,00
DA32N220PI	860,00
DA32N220PIS	960,00

**Siłownik do przepustnic bez sprężyny powrotnej z przyspieszonym biegiem**

• Fast running non spring return actuator for dampers



8 Nm	Cena [PLN/szt.] • Price [PLN/pc]
DA08F24	470,00
DA08F24S	510,00
DA08F24PI	640,00
DA08F24PIS	730,00
DA08F220	500,00
DA08F220S	560,00
DA08F220PI	650,00
DA08F220PIS	690,00

16 Nm	Cena [PLN/szt.] • Price [PLN/pc]
DA16F24	600,00
DA16F24S	630,00
DA16F24PI	780,00
DA16F24PIS	830,00
DA16F220	660,00
DA16F220S	690,00
DA16F220PI	860,00
DA16F220PIS	910,00



## Siłownik do przepustnic ze sprężyną powrotną • Spring return actuator for dampers



3 Nm	Cena [PLN/szt.] • Price [PLN/pc]
<b>DA03S24</b>	490,00
<b>DA03S24S</b>	490,00
<b>DA03S220</b>	490,00
<b>DA03S220S</b>	490,00

5 Nm	Cena [PLN/szt.] • Price [PLN/pc]
<b>DA05S24</b>	640,00
<b>DA05S24S</b>	640,00
<b>DA05S220</b>	640,00
<b>DA05S220S</b>	660,00



10 Nm	Cena [PLN/szt.] • Price [PLN/pc]
<b>DA10S24</b>	750,00
<b>DA10S24S</b>	780,00
<b>DA10S220</b>	780,00
<b>DA10S220S</b>	800,00

15 Nm	Cena [PLN/szt.] • Price [PLN/pc]
<b>DA15S24</b>	900,00
<b>DA15S24S</b>	1 050,00
<b>DA15S220</b>	1 000,00
<b>DA15S220S</b>	1 150,00



## Siłownik do przepustnic bez sprężyny powrotnej • Actuator for dampers without return spring



LM 5 Nm	Cena [PLN/szt.] • Price [PLN/pc]
LM230A	513,00
LM230A-F	513,00
LM230A-S	581,00
LM230ASR	831,00
LM24A	513,00
LM24A-F	513,00
LM24A-MOD	994,00
LM24A-MP	773,00
LM24A-S	581,00
LM24A-SR	696,00
LM24A-SR-F	696,00

NM 10 Nm	Cena [PLN/szt.] • Price [PLN/pc]
NM230A	648,00
NM230A-F	648,00
NM230A-S	773,00
NM230ASR	1 043,00
NM24A	626,00
NM24A-F	626,00
NM24A-MP	998,00
NM24AP5	860,00
NM24A-S	754,00
NM24A-SR	908,00
NM24A-SR-F	908,00



SM 20 Nm	Cena [PLN/szt.] • Price [PLN/pc]
SM230A	738,00
SM230A-S	921,00
SM230ASR	1 161,00
SM24A	722,00
SM24A-MA	1 283,00
SM24A-MOD	1 331,00
SM24A-MP	1 139,00
SM24AP5	1 011,00

CM 2 Nm	Cena [PLN/szt.] • Price [PLN/pc]
CM230-F(-L/-R)	436,00
CM230G(-L/-R)	478,00
CM230(-L/-R)	449,00
CM24-F-L	417,00
CM24G(-L/-R)	465,00
CM24G-SR(-L/-R)	670,00
CM24(-L/-R)	433,00
CM24-SR-F(-L/-R)	613,00
CM24-T(-L/-R)	407,00



## Siłownik do przepustnic bez sprężyny powrotnej • Actuators for damper without return spring



GM 40 Nm	Cena [PLN/szt.] • Price [PLN/pc]
<b>GM230A</b>	1 299,00
<b>GM230A-TP</b>	1 299,00
<b>GM230G-T</b>	2 563,00
<b>GM24A</b>	1 277,00
<b>GM24A-MOD</b>	1 800,00
<b>GM24A-MP</b>	1 643,00
<b>GM24A-MP-TP</b>	1 643,00
<b>GM24A-SR</b>	1 540,00
<b>GM24A-SR-TP</b>	1 540,00
<b>GM24A-TP</b>	1 277,00
<b>GM24G-MP-T</b>	2 910,00
<b>GM24G-SR-T</b>	2 746,00
<b>GM24G-T</b>	2 544,00

LMQ 4 Nm	Cena [PLN/szt.] • Price [PLN/pc]
<b>LMQ24A</b>	1 036,00
<b>LMQ24A-MF</b>	1 168,00
<b>LMQ24A-SR</b>	1 068,00

LMC 5 Nm	Cena [PLN/szt.] • Price [PLN/pc]
<b>LMC230A (-F)</b>	529,00
<b>LMC24A (-F)</b>	529,00
<b>LMC24A-SR (-F)</b>	715,00

NMQ 8 Nm	Cena [PLN/szt.] • Price [PLN/pc]
<b>NMQ24A</b>	1 142,00
<b>NMQ24A-MF</b>	1 395,00
<b>NMQ24A-SR</b>	1 283,00

NMC 10 Nm	Cena [PLN/szt.] • Price [PLN/pc]
<b>NMC24A-MP</b>	1 059,00

SMQ 16 Nm	Cena [PLN/szt.] • Price [PLN/pc]
<b>SMQ24A</b>	1 245,00
<b>SMQ24A-MF</b>	1 546,00
<b>SMQ24A-SR</b>	1 424,00

SMD 16 Nm	Cena [PLN/szt.] • Price [PLN/pc]
<b>SMD24A</b>	1 001,00

SMD 20 Nm	Cena [PLN/szt.] • Price [PLN/pc]
<b>SMC24A-MP</b>	1 190,00

## Wyposażenie • Additional equipment

Typ • Type	Cena [PLN/szt.] • Price [PLN/pc]
<b>UK24BAC</b>	2 647,00
<b>UK24EIB</b>	2 839,00
<b>UK24LON</b>	2 454,00
<b>UK24MOD</b>	2 342,00
<b>MFT-C</b>	1 059,00



## Siłownik do przepustnic ze sprężyną powrotną • Actuator for dampers with return spring



LF 4 Nm	Cena [PLN/szt.] • Price [PLN/pc]
<b>LF230</b>	876,00
<b>LF230-S</b>	994,00
<b>LF24</b>	805,00
<b>LF24-3</b>	994,00
<b>LF24-MFT</b>	1 168,00
<b>LF24-S</b>	930,00
<b>LF24-SR</b>	1 091,00



TF 2 Nm	Cena [PLN/szt.] • Price [PLN/pc]
<b>TF230</b>	712,00
<b>TF230-S</b>	834,00
<b>TF24</b>	661,00
<b>TF24-3</b>	828,00
<b>TF24-MFT</b>	940,00
<b>TF24-S</b>	780,00
<b>TF24-SR</b>	892,00



NF 10 Nm	Cena [PLN/szt.] • Price [PLN/pc]
<b>NF24A</b>	1 017,00
<b>NF24A-3</b>	1 428,00
<b>NF24A-MOD</b>	1 659,00
<b>NF24A-MP</b>	1 495,00
<b>NF24A-S2</b>	1 155,00
<b>NF24A-SR</b>	1 222,00
<b>NF24A-SR-S2</b>	1 363,00
<b>NF24A-SZ</b>	1 222,00
<b>NF24A-SZ-S2</b>	1 363,00
<b>NF24G-MP-L</b>	2 749,00
<b>NF24G-SR-L</b>	2 489,00
<b>NF24G-SR-S2-L</b>	2 675,00



SF 20 Nm	Cena [PLN/szt.] • Price [PLN/pc]
<b>SF24A</b>	1 254,00
<b>SF24A-3</b>	1 591,00
<b>SF24A-MOD</b>	1 803,00
<b>SF24A-MP</b>	1 649,00
<b>SF24A-S2</b>	1 389,00
<b>SF24A-SR</b>	1 450,00
<b>SF24A-SR-S2</b>	1 553,00
<b>SF24A-SZ</b>	1 450,00
<b>SF24A-SZ-S2</b>	1 553,00
<b>SF24G-MP-L</b>	2 855,00
<b>SF24G-SR-L</b>	2 589,00
<b>SF24G-SR-S2-L</b>	2 752,00



## Akcesoria mechaniczne

• Mechanical accessories

Typ • Type	Cena [PLN/szt.] • Price [PLN/pc]
<b>AH-20</b>	47,00
<b>AH-25</b>	47,00
<b>AH-GMA</b>	82,00

Typ • Type	Cena [PLN/szt.] • Price [PLN/pc]
<b>AV6-20</b>	157,00
<b>AV8-25</b>	176,00

Typ • Type	Cena [PLN/szt.] • Price [PLN/pc]
<b>K-NA</b>	85,00
<b>K-SA</b>	85,00

Typ • Type	Cena [PLN/szt.] • Price [PLN/pc]
<b>KG8</b>	49,00

Typ • Type	Cena [PLN/szt.] • Price [PLN/pc]
<b>ZG-NMA</b>	196,00
<b>ZG-SMA</b>	212,00
<b>ZG-TF1</b>	327,00

Typ • Type	Cena [PLN/szt.] • Price [PLN/pc]
<b>Z-SMA</b>	31,00

## Akcesoria elektryczne

• Electrical accessories

Typ • Type	Cena [PLN/szt.] • Price [PLN/pc]
<b>S1A</b>	212,00
<b>S2A</b>	282,00
<b>S2A-F</b>	420,00

Typ • Type	Cena [PLN/szt.] • Price [PLN/pc]
<b>P1000A</b>	343,00
<b>P1000A</b>	343,00
<b>P1000A-F</b>	491,00
<b>P140A</b>	343,00
<b>P200A</b>	343,00
<b>P200A-F</b>	491,00
<b>P2800A</b>	343,00
<b>P5000A</b>	343,00
<b>P500A</b>	343,00

Typ • Type	Cena [PLN/szt.] • Price [PLN/pc]
<b>SGA24</b>	456,00
<b>SGE24</b>	456,00
<b>SGF24</b>	324,00



## Klimatyzator ścienny • Split AC

XA71I

NOWOŚĆ • NEW



I FEEL



I SET



AUTORESTART



WI-FI



INTELIŻENTNY  
NAWIEW



TRYB NOCNY



ULTRACIŁY



AUTO MODE



PAMIĘĆ  
ZAŁUŻII



OBUSTRONNE  
POŁĄCZENIE



ENERGO-  
OSZCZĘDNY



EKOLOGICZNY  
CZYNNIK

Model	Chłodzenie • Cooling [kW]	Grzanie • Heating [kW]	Średnica rur • Pipes diameter [cale]	Cena katalogowa [USD/kpl.] • Basic price [USD/set]
TAC-09CHSD/XA71I	2,6	2,8	1/4 - 3/8	530,00
TAC-12CHSD/XA71I	3,5	3,7	1/4 - 3/8	560,00
TAC-18CHSD/XA71I	5,1	5,2	1/4 - 3/8	940,00
TAC-24CHSD/XA71I	6,8	6,9	1/4 - 1/2	1 160,00

## Klimatyzator ścienny • Split AC

XA81



6-WARSTWOWY  
FILTR



I FEEL



AUTORESTART



WI-FI



INTELIŻENTNY  
NAWIEW



TRYB NOCNY



ULTRACIŁY



AUTO MODE



PAMIĘĆ  
ZAŁUŻII



OBUSTRONNE  
POŁĄCZENIE



ENERGO-  
OSZCZĘDNY



EKOLOGICZNY  
CZYNNIK

Model	Chłodzenie • Cooling [kW]	Grzanie • Heating [kW]	Średnica rur • Pipes diameter [cale]	Cena katalogowa [USD/kpl.] • Basic price [USD/set]
TAC-09CHSD/XA81	2,6	2,8	1/4 - 3/8	535,00
TAC-12CHSD/XA81	3,5	3,7	1/4 - 3/8	565,00

PLATNOŚĆ GOTÓWKOWA - DODATKOWY RABAT 2% - CASH PAYMENT - ADDITIONAL DISCOUNT OF 2%

Ceny przeliczone na PLN w dniu sprzedaży wg kursów średnich NBP.



## Klimatyzator ścienny • Split AC

YA11I



NOWOŚĆ • NEW



Model	Chłodzenie • Cooling [kW]	Grzanie • Heating [kW]	Średnica rur • Pipes diameter [cale]	Cena katalogowa [USD/kpl.] • Basic price [USD/set]
TAC-09CHSD/YA11I	2,6	2,8	1/4 - 3/8	590,00
TAC-12CHSD/YA11I	3,4	3,4	1/4 - 3/8	620,00

## Klimatyzator przenośny • Portable AC

LIN



NOWOŚĆ • NEW



Model	Chłodzenie • Cooling [kW]	Grzanie • Heating [kW]	Średnica rur • Pipes diameter [cale]	Cena katalogowa [USD/szt.] • Basic price [USD/pc]
LIN-12LHPB/KA	3,2	2,9	-	570,00

**PŁATNOŚĆ GOTÓWKOWA - DODATKOWY RABAT 2% • CASH PAYMENT - ADDITIONAL DISCOUNT OF 2%**

Ceny przeliczone na PLN w dniu sprzedaży wg kursów średnich NBP.

2020-03-16 CENY PODANE W CENNIKU LINDAB SP. Z O.O. NIE ZAWIERAJĄ PODATKU VAT  
/ RATES IN THIS PRICELIST ARE NET PRICES

NOWOŚĆ • NEW

## Jednostka zewnętrzna MULTI SPLIT • External multi split unit

FMA



Model	Chłodzenie • Cooling [kW]	Grzanie • Heating [kW]	Średnica rur • Pipes diameter [cale]	Cena katalogowa [USD/szt.] • Basic price [USD/pc]
<b>FMA-18I2HD/DVO</b>	5,2	5,2	1/4 - 3/8	870,00
<b>FMA-32I4HD/DVO</b>	9,4	9,4	1/4 - 3/8	1 530,00

## Jednostka wewnętrzna ścienna MULTI SPLIT • Internal multi split unit

FMA

NOWOŚĆ • NEW



Model	Chłodzenie • Cooling [kW]	Grzanie • Heating [kW]	Średnica rur • Pipes diameter [cale]	Cena katalogowa [USD/szt.] • Basic price [USD/pc]
<b>FMA-09CHSA/DVI</b>	2,6	2,6	1/4 - 3/8	160,00
<b>FMA-12CHSA/DVI</b>	3,5	3,5	1/4 - 3/8	170,00
<b>FMA-18CHSA/DVI</b>	5,0	5,0	1/4 - 3/8	220,00

**PLATNOŚĆ GOTÓWKOWA - DODATKOWY RABAT 2% • CASH PAYMENT - ADDITIONAL DISCOUNT OF 2%**

Ceny przeliczone na PLN w dniu sprzedaży wg kursów średnich NBP.



## Klimatyzator ścienny • Split AC



Model	Chłodzenie • Cooling [kW]	Grzanie • Heating [kW]	Średnica rur • Pipes diameter [cale]	Cena katalogowa [PLN/kpl.] • Basic price [PLN/set]
<b>DCS22FX-09HRLB1X</b>	2,60	2,90	1/4 - 3/8	2 550,00
<b>DCS22FX-12HRLB1X</b>	3,50	3,80	1/4 - 3/8	2 700,00
<b>DCS22FX-18HRLB1X</b>	5,20	5,50	1/4 - 1/2	4 300,00
<b>DCS22FX-24HRLB1X</b>	7,00	7,30	3/8 - 5/8	5 500,00

## Klimatyzator kanałowy • Duct AC



Model	Chłodzenie • Cooling [kW]	Grzanie • Heating [kW]	Średnica rur • Pipes diameter [cale]	Cena katalogowa [PLN/kpl.] • Basic price [PLN/set]
<b>DKB-12HHLB1X / DOBA-12HLB1X</b>	3,50	3,80	1/4 - 3/8	5 000,00
<b>DKB-18HHLB1X / DOBA-18HLB1X</b>	5,30	5,60	1/4 - 1/2	7 000,00
<b>DKB-24HHLB1X / DOBA-24HLB1X</b>	7,00	7,00	3/8 - 5/8	8 800,00

PLATNOŚĆ GOTÓWKOWA - DODATKOWY RABAT 2% • CASH PAYMENT - ADDITIONAL DISCOUNT OF 2%



## Klimatyzator kasetonowy Compact • Cassette Compact AC



Model	Chłodzenie • Cooling [kW]	Grzanie • Heating [kW]	Średnica rur • Pipes diameter [cale]	Cena katalogowa [PLN/kpl.] • Basic price [PLN/set]
<b>DCA3X-12HRLB1X / DOBA-12HRLB1X</b>	3,50	4,10	1/4 - 3/8	5 350,00

## Klimatyzator kasetonowy • Cassette AC



Model	Chłodzenie • Cooling [kW]	Grzanie • Heating [kW]	Średnica rur • Pipes diameter [cale]	Cena katalogowa [PLN/kpl.] • Basic price [PLN/set]
<b>DKD-18HRLB1X / DOBA-18HLB1X</b>	5,30	5,60	1/4 - 1/2	7 100,00
<b>DKD-24HRLB1X / DOBA-18HLB1X</b>	7,00	7,00	3/8 - 5/8	8 800,00
<b>DKD-48HRLB1X / DOBA-48HLB1X</b>	13,80	16,10	3/8 - 3/4	13 900,00

PLATNOŚĆ GOTÓWKOWA - DODATKOWY RABAT 2% • CASH PAYMENT - ADDITIONAL DISCOUNT OF 2%



## Jednostka zewnętrzna • External unit



AUTORESTART



DC INVERTER



MULTI

Model	Chłodzenie • Cooling [kW]	Grzanie • Heating [kW]	Cena katalogowa [PLN/szt.] • Basic price [PLN/pc]
DD20X-16HLB1X-Q	4,10	4,40	4 600,00
DD30X-21HLB1X-Q	6,20	6,60	5 850,00

## Jednostka wewnętrzna ścienna • Internal split unit



GRZANIE



CHŁODZENIE



WENTYLATOR



AUTO



AUTORESTART



PILOT



SLEEP



TIMER



TURBO



DC INVERTER



SWING



MULTI

Model	Chłodzenie • Cooling [kW]	Grzanie • Heating [kW]	Średnica rur • Pipes diameter [cale]	Cena katalogowa [PLN/kpl.] • Basic price [PLN/set]
DCS22FX-09HRLB1X	2,60	2,90	1/4 - 3/8	750,00
DCS22FX-12HRLB1X	3,50	3,80	1/4 - 3/8	850,00

PLATNOŚĆ GOTÓWKOWA - DODATKOWY RABAT 2% • CASH PAYMENT - ADDITIONAL DISCOUNT OF 2%



## Klimatyzator ścienny • Split AC



GRZANIE



CHŁODZENIE



WENTYLATOR



AUTO



AUTORESTART



PILOT



SLEEP



TIMER



TURBO



DC INVERTER

Model	Chłodzenie • Cooling [kW]	Grzanie • Heating [kW]	Średnica rur • Pipes diameter [cale]	Cena katalogowa [PLN/kpl.] • Basic price [PLN/set]
DS12FU-09HRFN1	2,60	2,80	1/4 - 3/8	2 440,00
DS12FU-12HRFN1	3,50	3,70	1/4 - 3/8	2 640,00
DS12FU-18HRFN1	5,10	5,30	1/4 - 1/2	3 940,00

PLATNOŚĆ GOTÓWKOWA - DODATKOWY RABAT 2% • CASH PAYMENT - ADDITIONAL DISCOUNT OF 2%



## Klimatyzator kasetonowy • Cassette AC



Model	Chłodzenie • Cooling [kW]	Grzanie • Heating [kW]	Średnica rur • Pipes diameter [cale]	Cena katalogowa [PLN/kpl.] • Basic price [PLN/set]
<b>DCD-18HRFN1 / DOU-18HRFN1</b>	5,30	7,30	1/4 - 1/2	7 390,00
<b>DCD-24HRFN1 / DOU-24HRFN1</b>	7,00	7,70	3/8 - 5/8	9 790,00
<b>DCD-36HRFN1 / DOU-36HRFN1</b>	10,50	11,00	3/8 - 5/8	13 990,00

## Klimatyzator kasetonowy • Cassette AC



Model	Chłodzenie • Cooling [kW]	Grzanie • Heating [kW]	Średnica rur • Pipes diameter [cale]	Cena katalogowa [PLN/kpl.] • Basic price [PLN/set]
<b>DCD-45HRN1 / DOU-45HRN1</b>	13,00	14,50	3/8 - 3/4	10 500,00
<b>DCD-51HRN1 / DOU-51HRN1</b>	14,50	17,50	3/8 - 3/4	12 500,00

**PLATNOŚĆ GOTÓWKOWA - DODATKOWY RABAT 2% - CASH PAYMENT - ADDITIONAL DISCOUNT OF 2%**



## Klimatyzator przypodłogowo-podsufitowy • Floor ceiling AC



Model	Chłodzenie • Cooling [kW]	Grzanie • Heating [kW]	Średnica rur • Pipes diameter [cale]	Cena katalogowa [PLN/kpl.] • Basic price [PLN/set]
<b>DUE-24HRFN1 / DOU-24HRFN1</b>	7,00	7,70	3/8 - 5/8	9 000,00

## Klimatyzator przypodłogowo-podsufitowy • Floor ceiling AC



Model	Chłodzenie • Cooling [kW]	Grzanie • Heating [kW]	Średnica rur • Pipes diameter [cale]	Cena katalogowa [PLN/kpl.] • Basic price [PLN/set]
<b>DUE-45HRN1 / DOU-45HRN1</b>	13,00	14,50	3/8 - 3/4	9 900,00

PLATNOŚĆ GOTÓWKOWA - DODATKOWY RABAT 2% • CASH PAYMENT - ADDITIONAL DISCOUNT OF 2%





## Klimatyzator kanałowy • Duct AC

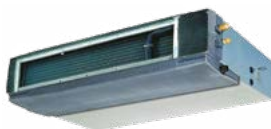

GRZANIE



CHŁODZENIE



WENTYLATOR



AUTO



AUTORESTART



SLEEP



TIMER



TURBO



DC INVERTER

Model	Chłodzenie • Cooling [kW]	Grzanie • Heating [kW]	Średnica rur • Pipes diameter [cale]	Cena katalogowa [PLN/kpl.] • Basic price [PLN/set]
DTA-18HWFN1 / DOU-18HRFN1	5,00	5,00	1/4 - 1/2	7 400,00
DTA-36HWFN1 / DOU-36HRFN1	10,50	11,00	3/8 - 5/8	13 600,00
DTA-48HWFN1 / DOU-48HRFN1	14,00	16,00	3/8 - 5/8	14 600,00
DTA-60HWFN1 / DOU-60HRFN1	16,00	17,50	3/8 - 5/8	15 600,00

## Klimatyzator kanałowy • Duct AC



ON / OFF



GRZANIE



CHŁODZENIE



WENTYLATOR



AUTO



AUTORESTART



SLEEP



TIMER



TURBO

Model	Chłodzenie • Cooling [kW]	Grzanie • Heating [kW]	Średnica rur • Pipes diameter [cale]	Cena katalogowa [PLN/kpl.] • Basic price [PLN/set]
DTB-45HRN1 / DOU-45HRN1	13,00	14,50	3/8 - 3/4	9 600,00
DTB-51HRN1 / DOU-51HRN1	14,50	17,50	3/8 - 3/4	11 600,00

PLATNOŚĆ GOTÓWKOWA - DODATKOWY RABAT 2% • CASH PAYMENT - ADDITIONAL DISCOUNT OF 2%

**Jednostka zewnętrzna - External unit**

AUTORESTART DC INVERTER MULTI

Model	Chłodzenie - Cooling [kW]	Grzanie - Heating [kW]	Cena katalogowa [PLN/szt.] - Basic price [PLN/pc]
<b>D5OC-36</b>	10,50	12,00	8 900,00
<b>D5OD-42</b>	12,00	12,00	10 900,00

**PŁATNOŚĆ GOTÓWKOWA - DODATKOWY RABAT 2% - CASH PAYMENT - ADDITIONAL DISCOUNT OF 2%**



## Jednostka wewnętrzna ścienna • Internal split unit



Model	Chłodzenie • Cooling [kW]	Grzanie • Heating [kW]	Średnica rur • Pipes diameter [cale]	Cena katalogowa [PLN/szt.] • Basic price [PLN/pc]
DS12FU-09HRDN1	2,60	2,80	1/4 - 3/8	930,00
DS12FU-12HRFN1	3,50	3,80	1/4 - 3/8	990,00
DS12FU-18HRFN1	5,10	5,40	1/4 - 1/2	1 190,00

## Jednostka wewnętrzna kanałowa • Internal duct unit



Model	Chłodzenie • Cooling [kW]	Grzanie • Heating [kW]	Średnica rur • Pipes diameter [cale]	Cena katalogowa [PLN/szt.] • Basic price [PLN/pc]
DTBI-18HRDN1	5,30	6,20	1/4 - 3/8	2 200,00

PLATNOŚĆ GOTÓWKOWA - DODATKOWY RABAT 2% • CASH PAYMENT - ADDITIONAL DISCOUNT OF 2%



## Jednostka wewnętrzna kasetonowa • Internal cassette unit



GRZANIE



CHŁODZENIE



WENTYLATOR



AUTO



AUTORESTART



PILOT



SLEEP



TIMER



TURBO



DC INVERTER



SWING



POMPKA

Model	Chłodzenie • Cooling [kW]	Grzanie • Heating [kW]	Średnica rur • Pipes diameter [cale]	Cena katalogowa [PLN/szt.] • Basic price [PLN/pc]
DCA2I-07-HRDN1	2,10	2,30	1/4 - 3/8	1 700,00
DCD-09-HRDN1	2,60	2,80	1/4 - 3/8	1 800,00
DCA2I-18-HRDN1	5,10	5,80	1/4 - 1/2	2 400,00

## Jednostka wewnętrzna przypodłogowo-podsufitowa • Internal floor ceiling unit



GRZANIE



CHŁODZENIE



WENTYLATOR



AUTO



AUTORESTART



PILOT



SLEEP



TIMER



TURBO



DC INVERTER



SWING



MULTI

Model	Chłodzenie • Cooling [kW]	Grzanie • Heating [kW]	Średnica rur • Pipes diameter [cale]	Cena katalogowa [PLN/szt.] • Basic price [PLN/pc]
MUBI-12HRDN1	3,50	4,00	1/4 - 3/8	1 600,00
MUBI-18HRDN1	5,30	6,20	1/4 - 1/2	1 900,00

PLATNOŚĆ GOTÓWKOWA - DODATKOWY RABAT 2% • CASH PAYMENT - ADDITIONAL DISCOUNT OF 2%



## Klimatyzator ścienny • Split AC

## WINDFREE ULTRA

**MODEL  
2019**

Model	Chłodzenie • Cooling [kW]	Grzanie • Heating [kW]	Cena katalogowa [PLN/kpl.] • Basic price [PLN/set]
AR09NXCXAWKNEU/X	2,50	3,20	5 409,00
AR12NXCXAWKNEU/X	3,50	4,00	5 809,00

## Klimatyzator ścienny • Split AC

## WINDFREE OPTIMUM

**MODEL  
2019**

Model	Chłodzenie • Cooling [kW]	Grzanie • Heating [kW]	Cena katalogowa [PLN/kpl.] • Basic price [PLN/set]
AR09NXPXBWKNEU/X	2,50	3,20	4 949,00
AR12NXPXBWKNEU/X	3,50	3,50	5 299,00
AR18NSPXBWKNEU/X	5,00	6,00	8 119,00
AR24NSPXBWKNEU/X	6,50	7,40	10 239,00

## Klimatyzator ścienny • Split AC

## WINDFREE STANDARD

**MODEL  
2019**

Model	Chłodzenie • Cooling [kW]	Grzanie • Heating [kW]	Cena katalogowa [PLN/kpl.] • Basic price [PLN/set]
AR09NXWCWKNEU/X	2,75	3,20	4 129,00
AR12NXWCWKNEU/X	3,50	3,50	4 419,00
AR18NSWCWKNEU/X	5,00	6,00	6 779,00
AR24NSWCWKNEU/X	6,50	7,40	8 529,00

**PLATNOŚĆ GOTÓWKOWA - DODATKOWY RABAT 2% • CASH PAYMENT - ADDITIONAL DISCOUNT OF 2%**



## Klimatyzator ścienny • Split AC

## NEW TRIANGLE

**MODEL  
2019**

Model	Chłodzenie • Cooling [kW]	Grzanie • Heating [kW]	Cena katalogowa [PLN/kpl.] • Basic price [PLN/set]
AR09NXWSAURNEU/X	2,75	3,20	3 259,00
AR12NXWSAURNEU/X	3,50	3,50	3 489,00

## Klimatyzator ścienny • Split AC

## STANDARD

**MODEL  
2019**

Model	Chłodzenie • Cooling [kW]	Grzanie • Heating [kW]	Cena katalogowa [PLN/kpl.] • Basic price [PLN/set]
AR09NXFHBWKNEU/X	2,50	3,20	3 089,00
AR12NXFHBWKNEU/X	3,50	3,70	3 319,00
AR18NSFHBWKNEU/X	5,00	6,00	5 079,00
AR24NSFHBWKNEU/X	6,50	8,00	6 399,00

## Klimatyzator ścienny • Split AC

## ECO

**MODEL  
2019**

Model	Chłodzenie • Cooling [kW]	Grzanie • Heating [kW]	Cena katalogowa [PLN/kpl.] • Basic price [PLN/set]
AR09NXFPEWQNEU/X	2,75	3,20	2 999,00
AR12NXFPEWQNEU/X	3,50	3,50	3 219,00
AR18NSFPEWQNEU/X	5,00	6,00	4 929,00
AR24NSFPEWQNEU/X	6,50	7,40	6 219,00

**PLATNOŚĆ GOTÓWKOWA - DODATKOWY RABAT 2% • CASH PAYMENT - ADDITIONAL DISCOUNT OF 2%**



### Klimatyzator ścienny • Split AC

### STANDARD



Model	Chłodzenie • Cooling [kW]	Grzanie • Heating [kW]	Średnica rur • Pipes diameter [cale]	Cena katalogowa [PLN/kpl.] • Basic price [PLN/set]
AR09KSFHBWKNZE	2,50	3,20	1/4 - 3/8	3 719,00
AR12KSFHBWKNZE	3,50	3,70	1/4 - 3/8	3 729,00
AR18KSFHBWKNEU	5,00	6,00	1/4 - 1/2	5 359,00

### Klimatyzator ścienny • Split AC

### CLASSIC+



Model	Chłodzenie • Cooling [kW]	Grzanie • Heating [kW]	Średnica rur • Pipes diameter [cale]	Cena katalogowa [PLN/kpl.] • Basic price [PLN/set]
AR09KSWSBWKNZE	2,50	3,20	1/4 - 3/8	3 989,00
AR12KSWSBWKNZE	3,50	3,80	1/4 - 3/8	4 079,00
AR18MSWSAWKXEU	5,00	6,00	1/4 - 1/2	5 729,00
AR24MSWSAWKNEU	6,80	7,70	1/4 - 5/8	6 999,00

PLATNOŚĆ GOTÓWKOWA - DODATKOWY RABAT 2% • CASH PAYMENT - ADDITIONAL DISCOUNT OF 2%



### Klimatyzator ścienny • Split AC

### PREMIUM



Model	Chłodzenie • Cooling [kW]	Grzanie • Heating [kW]	Średnica rur • Pipes diameter [cale]	Cena katalogowa [PLN/kpl.] • Basic price [PLN/set]
AR09KSPDBWKNEU	2,50	3,20	1/4 - 3/8	4 809,00
AR12KSPDBWKNEU	3,50	4,00	1/4 - 3/8	5 049,00

### Klimatyzator ścienny • Split AC

### PRESTIGE



Model	Chłodzenie • Cooling [kW]	Grzanie • Heating [kW]	Średnica rur • Pipes diameter [cale]	Cena katalogowa [PLN/kpl.] • Basic price [PLN/set]
AR09JSPFAWKNEU	2,50	3,20	1/4 - 3/8	5 559,00

PLATNOŚĆ GOTÓWKOWA - DODATKOWY RABAT 2% • CASH PAYMENT - ADDITIONAL DISCOUNT OF 2%

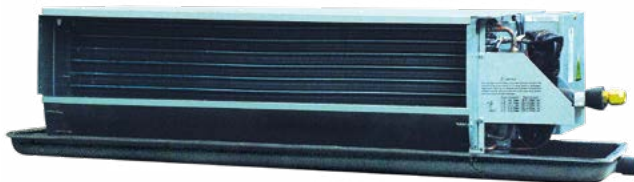

**Klimakonwektor kanałowy - Duct type fan coil unit**

Model	Chłodzenie • Cooling [kW]	Cena katalogowa [PLN/szt.] • Basic price [PLN/pc]
<b>FP200WAY30</b>	1,8	875,00
<b>FP300WAY30</b>	2,7	975,00
<b>FP400WAY30</b>	3,6	1 095,00
<b>FP500WAY30</b>	4,5	1 195,00
<b>FP1000WAY30</b>	9,0	1 695,00
<b>FP1400WAY30</b>	12,6	1 995,00

**Klimakonwektor kasetonowy - Cassette type fan coil unit**

Model	Chłodzenie • Cooling [kW]	Cena katalogowa [PLN/szt.] • Basic price [PLN/pc]
<b>FP51Q4M/300Q4M</b>	2,7	2 250,00
<b>FP102Q4M/600Q4M</b>	5,4	2 650,00
<b>FP136Q4M/800Q4M</b>	7,2	2 950,00

**Klimakonwektor przypodłogowo-podsufitowy** - Floor ceiling type fan coil unit

Model	Chłodzenie - Cooling [kW]	Cena katalogowa [PLN/szt.] - Basic price [PLN/pc]
<b>FP400LDM</b>	3,6	2 190,00
<b>FP600LDM</b>	5,4	2 390,00
<b>FP800LDM</b>	7,70	2 590,00

**Rura miedziana chłodnicza z izolacją • Insulated copper cooling pipes**

Rura miedziana wykonana zgodnie z normą UNI-EN 12735-1.

Przeznaczona do dystrybucji czynników chłodniczych.

Wyżarzana w zwojach, uszczelniona na końcach w celu zachowania czystej i suchej powierzchni wewnętrznej.

Odpowiednia grubość izolacji zapobiega kondensacji wody w normalnych warunkach pracy: temperatura płynu w rurze wyższa lub równa 7°C, temperatura wewnątrz pomieszczenia 27°C, wilgotność względna wewnątrz niższa lub równa 50%.

Wymiary podane w calach.

*A copper pipe made in accordance with UNI-EN 12735-1.*

*Designed for the distribution of cooling media.*

*Annealed in coils, sealed at ends to keep the internal surface clean and dry.*

*The appropriate thickness of insulation prevents water condensation under normal working conditions: the temperature of liquid in the pipe at least 7°C, temperature inside the room 27°C, internal relative humidity lower or equal to 50%.*

*Dimensions in inches.*

Typ • Type	Kraż • Coils [mb]	Cena katalogowa [PLN/opak.] • Basic price [PLN/pack.]
Rura miedziana chłodnicza z izolacją • Insulated copper cooling pipe		
<b>Rura miedziana 1/4"</b>	25	564,23
<b>Rura miedziana 3/8"</b>	25	846,25
<b>Rura miedziana 1/2"</b>	25	1 117,04
<b>Rura miedziana 5/8"</b>	25	1 698,16
<b>Rura miedziana 3/4"</b>	25	2 132,72
<b>Rura miedziana 7/8"</b>	25	2 801,39

**Rura miedziana chłodnicza twarda • Hard copper refrigeration tubes**

Produkt przygotowany do składowania i transportu - sztangi 5 mb, oczyszczone, korkowane na zewnątrz, foliowane. Klasa miedzi - wg normy UNI-EN 12735-1.

*Preparation for storing and transport - straight length of 5m, cleaned, plugged at both ends, wrapped with film. Copper grade - according to UNI-EN 12735-1 standard.*

Typ • Type	Grubość ścianki • Wall thickness [mm]	Cena katalogowa [PLN/mb] • Basic price [PLN/m]
1/2"	0,80	32,96
1/2"	1,00	40,58
5/8"	0,80	41,20
5/8"	1,00	50,37
3/4"	1,00	61,08
7/8"	1,00	71,89
1 1/8"	1,00	99,29
1 1/8"	1,25	122,98
1 3/8"	1,25	153,47
1 5/8"	1,25	182,31
2 1/8"	1,25	241,54
2 1/8"	1,65	316,52
2 5/8"	1,25	303,23
2 5/8"	1,65	397,99
2 5/8"	2,00	480,08



## Kolano 90° dwukielichowe

• Elbow C×C 90°



Typ · Type	Cena [PLN/szt.] • Price [PLN/pc]
1/2"	3,19
5/8"	4,64
3/4"	7,73
7/8"	10,30
1 1/8"	19,06
1 3/8"	30,39
1 5/8"	43,78
2 1/8"	89,20
2 5/8"	148,01

## Kolano 45° dwukielichowe

• Elbow C×C 45°



Typ · Type	Cena [PLN/szt.] • Price [PLN/pc]
5/8"	4,43
3/4"	7,52
7/8"	9,68
1 1/8"	18,64
1 3/8"	24,93
1 5/8"	39,55
2 1/8"	76,01
2 5/8"	123,70

## Kolano 45° jednokielichowe

• Elbow C×FTG 45°



Typ · Type	Cena [PLN/szt.] • Price [PLN/pc]
5/8"	5,05
3/4"	7,52
7/8"	10,92
1 1/8"	19,88
1 3/8"	29,46
1 5/8"	50,68
2 1/8"	87,24
2 5/8"	131,84

## Trójnik równoprzelotowy

• Regular tee C×C×C



Typ · Type	Cena [PLN/szt.] • Price [PLN/pc]
5/8"×5/8"×5/8"	9,17
3/4"×3/4"×3/4"	15,24
7/8"×7/8"×7/8"	20,29
1 1/8"×1 1/8"×1 1/8"	36,46
1 3/8"×1 3/8"×1 3/8"	55,72
1 5/8"×1 5/8"×1 5/8"	81,16
2 1/8"×2 1/8"×2 1/8"	152,13

## Trójnik redukcyjny

• Reducing tee



Typ · Type	Cena [PLN/szt.] • Price [PLN/pc]
5/8"×1/2"×5/8"	12,57
7/8"×5/8"×7/8"	19,47
1 1/8"×7/8"×1 1/8"	38,52
1 1/8"×1 3/8"×1 1/8"	73,03
1 3/8"×1/2"×1 3/8"	50,68
1 5/8"×1 3/8"×1 5/8"	97,34
2 5/8"×1 5/8"×2 5/8"	182,52



## Redukcja mufa/nypel - Reducer



Typ - Type	Cena [PLN/szt.] - Price [PLN/pc]
<b>3/8" × 1/4"</b>	3,09
<b>1/2" × 1/4"</b>	4,64
<b>5/8" × 1/2"</b>	4,33
<b>7/8" × 5/8"</b>	7,11
<b>1 1/8" × 5/8"</b>	13,80
<b>1 5/8" × 7/8"</b>	31,42
<b>2 1/8" × 1 3/8"</b>	60,87
<b>2 5/8" × 1 5/8"</b>	95,28

## Łuk dwukielichowy - Long elbow C×C



Typ - Type	Cena [PLN/szt.] - Price [PLN/pc]
<b>1/2"</b>	5,05
<b>5/8"</b>	7,00
<b>3/4"</b>	10,82
<b>7/8"</b>	14,83
<b>1 1/8"</b>	29,05
<b>1 3/8"</b>	44,08
<b>1 5/8"</b>	72,10
<b>2 1/8"</b>	144,30
<b>2 5/8"</b>	244,52

## Łącznik mufa - Adapter



Typ - Type	Cena [PLN/szt.] - Price [PLN/pc]
<b>5/8"</b>	3,09
<b>3/4"</b>	4,64
<b>7/8"</b>	6,49
<b>1 1/8"</b>	12,15
<b>1 3/8"</b>	16,58
<b>1 5/8"</b>	26,37
<b>2 1/8"</b>	50,68
<b>2 5/8"</b>	85,18

## Łuk jednokielichowy - Long elbow C×FTG



Typ - Type	Cena [PLN/szt.] - Price [PLN/pc]
<b>1/2"</b>	5,05
<b>5/8"</b>	7,42
<b>3/4"</b>	11,02
<b>7/8"</b>	15,24
<b>1 1/8"</b>	30,49
<b>1 3/8"</b>	50,68
<b>1 5/8"</b>	84,15
<b>2 1/8"</b>	146,26
<b>2 5/8"</b>	250,50

## Syfon - Suction P-trap



Typ - Type	Cena [PLN/szt.] - Price [PLN/pc]
<b>3/4"</b>	60,87
<b>7/8"</b>	73,03
<b>1 1/8"</b>	101,46
<b>1 3/8"</b>	174,38
<b>1 5/8"</b>	298,19
<b>2 1/8"</b>	538,48



## Czynnik chłodniczy • Refrigerant



**Produkt posiada kartę bezpieczeństwa, dokument dopuszczający do stosowania czynnika na terenie Polski.**

W przypadku zwrotu butli w terminie:

- do 6 miesięcy od daty zakupu - zwracamy 100% wartości kaucji,
- do 12 miesięcy od daty zakupu - zwracamy 50% wartości kaucji,
- powyżej 12 miesięcy od daty zakupu - zwracamy 20% wartości kaucji.

*The product has the MSDS, marketing authorization for use in Poland.*

*In case of returning the container within:*

- 6 months since purchase - we give 100% of its price back,
- 12 months since purchase - we give 50% of the deposit back,
- more than 12 months since purchase - we give 20% of the deposit back.

Typ • Type	Wielkość butli • Cylinder size	Cena butli • Cylinder price [PLN]	Ilość czynnika • Quantity refrigerant [kg]	Cena katalogowa [PLN/opak.] • Basic price [PLN/pack.]
<b>R32</b> Butla wielorazowa • Multiple-use cylinder	10	150,00	9,0	na zapytanie ofertowe
<b>R134A</b> Butla wielorazowa • Multiple-use cylinder	10	150,00	11,0	
	10	150,00	12,2	
	20	150,00	25,0	
<b>R404A</b> Butla wielorazowa • Multiple-use cylinder	10	150,00	11,0	
	20	150,00	25,0	
<b>R407C</b> Butla wielorazowa • Multiple-use cylinder	10	150,00	11,0	
	20	150,00	25,0	
<b>R410A</b> Butla wielorazowa • Multiple-use cylinder	10	150,00	9,8	
	10	150,00	11,0	
	20	150,00	25,0	

**Uwaga! Możliwy jest zakup czynnika w zbiornikach tonowych.**



## Mocowanie skraplacza - Condenser fixing

**SL**

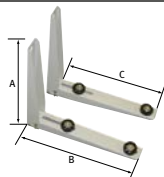

Łapy składane WZMOCNIONE śrubami, malowane proszkowo RAL1013.  
Możliwość regulacji rozstawu amortyzatorów.  
Kompletny zestaw przygotowany do montażu  
(kołki rozporowe, wkręty, amortyzatory).

Folded arms connected by 3 screws, powder painted (RAL 1013).  
Possible adjustment of spacing between the fixing shock absorbers  
A complete set ready for installation (installation plugs, screws, shock absorbers).

Typ • Type	Udźwig • Max. load [kg]	Wysokość • Height [cm]	Długość łap • Feet length [cm]	Szt./opak. • pc/pack	Cena [PLN/kpl.] • Price [PLN/set.]
<b>SL 430</b>	110	39	43	12	79,00
<b>SL 450</b>	120	39	45	4	90,54
<b>SL 550</b>	170	49	55	4	114,95

## Mocowanie skraplacza z poprzeczką i poziomnicą - Condenser tie

**HB**



Poprzeczka z możliwością regulacji mocowania.  
Łapy składane, malowane proszkowo RAL 1013.  
Możliwość regulacji rozstawu amortyzatorów mocujących.  
Poprzeczka mocująca wyposażona w poziomnicę.  
Kompletny zestaw przygotowany do montażu  
(kołki rozporowe, wkręty, amortyzatory).

A crossbar with adjustable fastening length.  
Folded arms, powder painted (RAL 1013).  
Possible adjustment of spacing between the fixing shock absorbers.  
A complete set ready for installation (installation plugs, screws, shock absorbers).

Typ • Type	Udźwig • Max. load [kg]	Wysokość • Height [cm]	Długość łap • Feet length [cm]	Długość poprzeczki • Crossbar [cm]	Cena [PLN/kpl.] • Price [PLN/set.]
<b>HB 420</b>	120	37,5	42	79	115,98
<b>HB 550</b>	160	37,5	55	96	140,90





## Mocowanie dachowe skraplacza • Roof tie

RS



Możliwość regulacji kąta w zakresie 10-28.  
Łapy składane, malowane proszkowo RAL1013.  
Możliwość regulacji rozstawu amortyzatorów mocujących.  
Kompletny zestaw przygotowany do montażu  
(kołki rozporowe, wkręty, amortyzatory).

Angle adjustment: from 10 to 28.  
Folding feet, powder coated to RAL1013.  
Adjustable spacing of shock absorbers.  
A complete set ready for installation (installation plugs, screws, shock absorbers).

Typ • Type	Udźwig • Max. load [kg]	Wysokość • Height [cm]	Długość łap • Feet length [cm]	Cena [PLN/kpl.] • Price [PLN/set.]
<b>RS 550</b>	200	55	100	391,71

## Wspornik pod skraplacz • PCV holder

PVC



Wykonanie z PVC zapewnia brak wystąpienia korozji.  
Komórkowa struktura niweluje potrzebę stosowania podkładek amortyzujących.

PCV holder, no corrosion.  
Cellular structure makes shock absorbing washers unnecessary.

Typ • Type	Wymiary • Dimensions [cm]	Udźwig • Max. load [kg]	Szt./opak. • pc/pack	Cena [PLN/szt.] • Price [PLN/pc]
<b>PVC 351SP</b> Wspornik • holder	350 × 80	200	24	25,54
<b>PVC 451SP</b> Wspornik • holder	450 × 80	200	24	33,68
<b>PVC 342TS</b> Zaślepka • hole plug	x	x	24	6,90



## Koryto montażowe PVC „MIDI” + nastawna złączka PVC

• "MIDI" PVC trough + adjustable PVC connector



Typ • Type	Dług. • Length [m]	Szer. • Width [mm]	Wys. • Height [mm]	Opak. • Pack.	Cena • Price [PLN]
<b>PVC 0612MD</b> Koryto • Trough	2	60	45	24 m	16,48 / m
<b>PVC 0603ST</b> Złączka nastawna • Adjustable connector	x	60	x	30 szt. • pc	1,44 / szt. • pc



Typ • Type	Dług. • Length [m]	Szer. • Width [mm]	Wys. • Height [mm]	Opak. • Pack.	Cena • Price [PLN]
<b>PVC 1212MD</b> Koryto • Trough	2	110	75	8 m	35,43 / m
<b>PVC 1203ST</b> Złączka nastawna • Adjustable connector	x	110	x	20 szt. • pc	2,06 / szt. • pc

## Koryto montażowe PVC + nastawna złączka PVC

• PVC trough + adjustable PVC connector

### STANDARD BCF

Koryta oprócz łatwości montażu i estetycznego wyglądu posiadają folię ochronną, która zabezpiecza je przed uszkodzeniem podczas przechowywania, transportu i montażu.

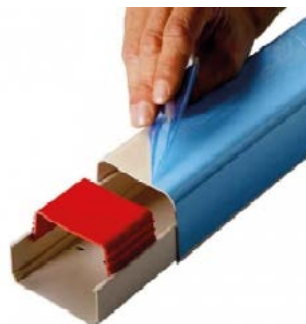

Typ • Type	Długość • Length [m]	Szerokość • Width [mm]	Wysokość • Height [mm]	Cena • Price [PLN]
<b>PVC 0312BC</b> Koryto • Trough	2	25	25	9,48 / m



Typ • Type	Długość • Length [m]	Szerokość • Width [mm]	Wysokość • Height [mm]	Cena • Price [PLN]
<b>PVC 0612BCF</b> Koryto • Trough	2	60	45	20,70 / m
<b>PVC 0603ST</b> Złączka nastawna • Adjustable connector	x	60	x	1,44 / szt. • pc



Typ • Type	Długość • Length [m]	Szerokość • Width [mm]	Wysokość • Height [mm]	Cena • Price [PLN]
<b>PVC 0712BCF</b> Koryto • Trough	2	70	55	24,21 / m
<b>PVC 0703ST</b> Złączka nastawna • Adjustable connector	x	70	x	1,55 / szt. • pc



Typ • Type	Długość • Length [m]	Szerokość • Width [mm]	Wysokość • Height [mm]	Cena • Price [PLN]
<b>PVC 0812BCF</b> Koryto • Trough	2	80	60	29,25 / m
<b>PVC 0803ST</b> Złączka nastawna • Adjustable connector	x	80	x	1,85 / szt. • pc



Typ • Type	Długość • Length [m]	Szerokość • Width [mm]	Wysokość • Height [mm]	Cena • Price [PLN]
<b>PVC 0912BCF</b> Koryto • Trough	2	90	65	34,40 / m
<b>PVC 0903ST</b> Złączka nastawna • Adjustable connector	x	90	x	1,75 / szt. • pc



Typ • Type	Długość • Length [m]	Szerokość • Width [mm]	Wysokość • Height [mm]	Cena • Price [PLN]
<b>PVC 1212BCF</b> Koryto • Trough	2	110	75	41,82 / m
<b>PVC 1203ST</b> Złączka nastawna • Adjustable connector	x	110	x	2,06 / szt. • pc

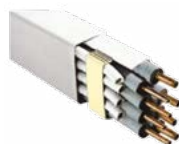

Typ • Type	Długość • Length [m]	Szerokość • Width [mm]	Wysokość • Height [mm]	Cena • Price [PLN]
<b>PVC 1412BCF</b> Koryto • Trough	2	140	90	63,96 / m
<b>PVC 1403ST</b> Złączka nastawna • Adjustable connector	x	140	x	2,47 / szt. • pc



## Narożnik zewnętrzny PVC

• External PVC corner



Typ • Type	Szerokość • Width [mm]	Op. <sup>7</sup>	Cena [PLN/szt.] • Price [PLN/pc]
<b>0306AE</b>	<b>25</b>	20	6,80
<b>0606AE</b>	<b>60</b>	12	12,05
<b>0706AE</b>	<b>70</b>	12	12,88
<b>0806AE</b>	<b>80</b>	9	13,70
<b>0906AE</b>	<b>90</b>	9	14,63
<b>1206AE</b>	<b>110</b>	6	17,30
<b>1406AE</b>	<b>140</b>	6	22,45

## Narożnik wewnętrzny PVC

• Internal PVC corner



Typ • Type	Szerokość • Width [mm]	Op. <sup>7</sup>	Cena [PLN/szt.] • Price [PLN/pc]
<b>0305AI</b>	<b>25</b>	20	6,80
<b>0605AI</b>	<b>60</b>	8	12,05
<b>0705AI</b>	<b>70</b>	8	12,88
<b>0805AI</b>	<b>80</b>	6	13,70
<b>0905AI</b>	<b>90</b>	6	14,63
<b>1205AI</b>	<b>110</b>	4	17,30
<b>1405AI</b>	<b>140</b>	4	22,45

## Łuk PVC • PVC bend



Typ • Type	Szerokość • Width [mm]	Op. <sup>7</sup>	Cena [PLN/szt.] • Price [PLN/pc]
<b>0307CP</b>	<b>25</b>	20	6,70
<b>0607CP</b>	<b>60</b>	10	13,70
<b>0707CP</b>	<b>70</b>	10	14,83
<b>0807CP</b>	<b>80</b>	8	18,95
<b>0907CP</b>	<b>90</b>	8	20,19
<b>1207CP</b>	<b>110</b>	6	24,93
<b>1407CP</b>	<b>140</b>	6	34,61

## Dekiel PVC • PVC end cap



Typ • Type	Szerokość • Width [mm]	Op. <sup>7</sup>	Cena [PLN/szt.] • Price [PLN/pc]
<b>0308TT</b>	<b>25</b>	20	6,80
<b>0608TT</b>	<b>60</b>	12	12,05
<b>0708TT</b>	<b>70</b>	12	12,57
<b>0808TT</b>	<b>80</b>	9	13,91
<b>0908TT</b>	<b>90</b>	9	14,32

<sup>7</sup> Ilość [szt./opak.] • Quantity [pcs/pack.]



## Kolano przyścienne PVC

• Wall side PVC bend



Typ • Type	Szerokość • Width [mm]	Op. 7	Cena [PLN/szt.] • Price [PLN/pc]
<b>0609CM</b>	<b>60</b>	9	17,51
<b>0709CM</b>	<b>70</b>	9	18,64
<b>0809CM</b>	<b>80</b>	6	21,63
<b>0909CM</b>	<b>90</b>	6	23,07
<b>1209CM</b>	<b>110</b>	4	26,78
<b>1409CM</b>	<b>140</b>	4	37,49

## Przejście ścienne PVC

• PVC thru-wall passage



Typ • Type	Szerokość • Width [mm]	Op. 7	Cena [PLN/szt.] • Price [PLN/pc]
<b>0610PM</b>	<b>60</b>	10	12,98
<b>0710PM</b>	<b>70</b>	10	13,70
<b>0810PM</b>	<b>80</b>	8	16,69
<b>0910PM</b>	<b>90</b>	8	17,61
<b>1210PM</b>	<b>110</b>	8	22,15
<b>1410PM</b>	<b>140</b>		31,00

## Opaska łącząca PVC

• PVC connecting band



Typ • Type	Szerokość • Width [mm]	Op. 7	Cena [PLN/szt.] • Price [PLN/pc]
<b>0304GC</b>	<b>25</b>	20	6,80
<b>0604GC</b>	<b>60</b>	30	6,28
<b>0704GC</b>	<b>70</b>		6,80
<b>0804GC</b>	<b>80</b>	30	8,24
<b>0904GC</b>	<b>90</b>	30	8,76
<b>1204GC</b>	<b>110</b>	20	9,27
<b>1404GC</b>	<b>140</b>		12,15

## Trójnik PVC

• PVC T connection



Typ • Type	Szerokość • Width [mm]	Op. 7	Cena [PLN/szt.] • Price [PLN/pc]
<b>0813DT</b>	<b>80</b>	4	32,14
<b>0913DT</b>	<b>90</b>	4	34,71
<b>1213DT</b>	<b>110</b>	2	40,17
<b>1413DT</b>	<b>140</b>	2	56,24

## Łącznik PVC

• PVC connector



Typ • Type	Szerokość • Width [mm]	Op. 7	Cena [PLN/szt.] • Price [PLN/pc]
<b>0611GF</b>	<b>60</b>	6	24,93
<b>0811GF</b>	<b>80</b>	4	28,53



## Rura do odprowadzania skroplin • Pipe for drips



Typ • Type	Szerokość • Width [mm]	Op. 1)	Cena [PLN/szt.] • Price [PLN/pc]
<b>0016TU</b>	<b>16</b>	30	116,18
<b>0018TU</b>	<b>18</b>	30	143,38
<b>0020TU</b>	<b>20</b>	30	159,75

## Regulator ciśnienia skraplania ERPO-7APC

• ERPO-7APC condensing pressure regulator



Cena [PLN/szt.] • Price [PLN/pc]

387,90

## Grzałka karteru sprężarki

• Compressors casing heater



Długość • Length [mm]

Cena [PLN/szt.] • Price [PLN/pc]

450

42,54

900

55,72

## Pompa skroplin • Condensate removal pump

### MINI DROP

Pompy skroplin montowane nad sufitem podwieszanym lub w korytach montażowych.

Wymiary (wys. x szer. x głęb.): 65 x 104 x 32 mm.

Waga: 0,25 kg.

Zewnętrzna średnica rury: 6mm.

Zasilanie: 230V, 50-60Hz.

Zużycie energii: 16W.

Znak CE.

W komplecie znajdują się: pompa skroplin, komplet kabli zasilających, zbiornik na skropliny, rurka wlotowa, rurka odpowietrzająca, podkładki antywibracyjne, opaski nylonowe.

The Mini Pump is designed to be installed: above the false ceiling where possible or in plastic conduit.

Size (HxWxD): 65x104x32 mm.

Weight: 0,25 kg.

Outlet tube size: 6mm i/d.

Power: 230V AC 50-60Hz 16W.

CE marked.

Includes: pump, power cable, reservoir, inlet tube, breather tube, cable ties, AV pad.



Nazwa • Name	Cena [PLN/szt.] • Price [PLN/pc]
<b>MINI DROP</b>	303,75

## MATERIAŁY MONTAŻOWE DO KLIMATYZATORÓW

Środki do czyszczenia i konserwacji urządzeń klimat., preparaty dezynfekcyjne

• Products for cleaning air conditioning devices, disinfection specimens

**Centrum  
Klima**



### FRIONETT® ACTIVE FOAM

Pianka w sprayu • *Spray foam*  
500 ml



Cena [PLN/szt.] • Price [PLN/pc]

122,26

### FRIONETT® ACTIV

koncentrat • *concentrate*  
5 l



Cena [PLN/szt.] • Price [PLN/pc]

318,27

### FRIONETT® POWER

koncentrat • *concentrate*  
5 l



Cena [PLN/szt.] • Price [PLN/pc]

418,8

### NANOCLEAN AIR 1 I

koncentrat • *concentrate*

Lawenda lub Orchidea • *Lavender or Orchid*



Gotowy do użycia preparat do mycia i dezynfekcji na poziomie bakteriobójczym i drożdżobójczym oraz do dezynfekcji na poziomie bakteriobójczym, grzybobójczym, drożdżobójczym, wirusobójczym i sporobójczym.

Cena [PLN/szt.] • Price [PLN/pc]

180,56

Opakowania zbiorcze • Collective packaging measurements

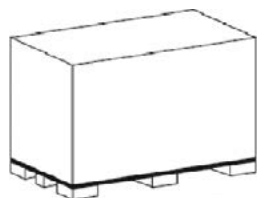

P1

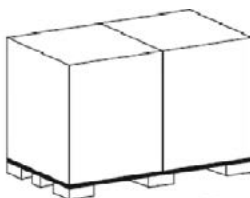

P2

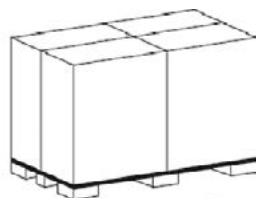

P4

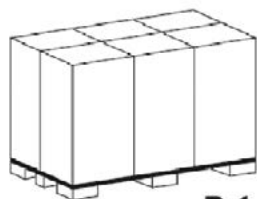

P6

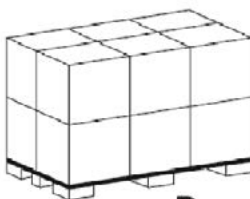

P12

Kod • Code	Długość • Length [mm]	Szerokość • Width [mm]	Wysokość • Height [mm]	Waga • Weight [kg]	Objętość • Volume [m <sup>3</sup> ]	Opak./paleta • Box/pallet [m <sup>3</sup> ]	Cena [PLN/szt.] • Price [PLN/pc]
P1	1200	800	800	4,63	0,770	1	30,18
P2	600	800	800	2,83	0,380	2	19,36
P4	600	400	800	1,34	0,190	4	9,58
P6	400	400	800	1,04	0,130	6	7,73
P12	400	400	400	0,71	0,064	12	5,77



## ZAMÓWIENIE POWYŻEJ 24 000 PLN DOSTAWA GRATIS

1. Odbiór własny z magazynu Lindab Sp. z o.o.:  
**WIERUCHÓW: ul. Sochaczewska 144, poniedziałek - piątek: 8:00 - 16:00,**  
**KRAKÓW: Liszki k. Krakowa, Morawica 356, poniedziałek - piątek: 8:00 - 16:00.**
2. Wysyłka firmą spedycyjną na koszt odbiorcy.  
Odbiorca ma prawo zamówić dowolną firmę transportową.
3. Wysyłki transportowe zryczałtowane, w dowolny punkt w Polsce, na zasadach:

WARTOŚĆ ZAMÓWIENIA NETTO PLN	ZRYCZAŁTOWANY KOSZT TRANSPORTU
<b>0 - 4 000</b>	koszt transportu 7% wartości netto (minimum 250 zł)
<b>UWAGA - jeśli wysyłany towar nie jest objętościowy lub ciężki i rzeczywiste koszty spedycji są znacznie niższe od kosztów zryczałtowanych - klient zostanie obciążony niższym kosztem rzeczywistym</b>	
<b>4 001 - 8 000</b>	koszt transportu 6% wartości netto (minimum 300 zł)
<b>8 001 - 15 000</b>	koszt transportu 5% wartości netto (minimum 450 zł)
<b>15 001 - 24 000</b>	koszt transportu 4% wartości netto
<b>&gt; 24 000</b>	<b>DOSTAWA BEZPŁATNA</b>

**UWAGI:**

1. Zryczałtowane koszty transportu obowiązują na terenie całej Polski i są takie same dla dowolnego punktu w kraju.
2. Lindab Sp. z o.o. zobowiązuje się, że transport zgodnie ze zryczałtowanymi kosztami transportu zostanie zrealizowany w maksimum 7 dni roboczych.
3. Zryczałtowanych kosztów transportu nie można używać do produktów gabarytowych tzn.:
  - rur spiro powyżej średnicy 315 mm,
  - kanałów i kształtek prostokątnych,
  - profili stalowych i kanałowych
 oraz do ofert specjalnych gdzie wyraźnie zostało zaznaczone, że koszt transportu będzie określany oddzielnie.  
Koszty transportu na wyżej wymienione produkty podlegają kalkulacji indywidualnej.
4. Zamówienia na materiały izolacyjne o wartości powyżej 7 000 zł netto dostarczane są bezpłatnie w dowolny punkt Polski (dotyczy zamówień realizowanych bezpośrednio z firmy Rockwool).
5. Koszty dostawy ekspresowej określane są indywidualnie.

**Dodatkowe informacje można uzyskać kontaktując się z naszym DZIAŁEM HANDLOWYM:**

**WIERUCHÓW  
KRAKÓW**

tel.: (22) 250 50 50  
tel.: 506 28 28 38

fax: (22) 250 50 60





